



Your Reliable Power Partner



Building Automation Solutions

Product Range Overview



Company Profile

Established in 1982, MEAN WELL is a leading standard switching power supply manufacturer in the world. MEAN WELL currently operates under five companies in Taiwan, China, USA and Europe and three factories in Taiwan, GuangZhou and SuZhou. The product lines include AC/DC switching power supplies, DC/DC converters, waterproof LED drivers, adaptors, DC/AC inverters and battery chargers. We have over 10,000 standard models widely used in medical, automation, communication, LED lighting, moving sign, and office automation applications.

With more than 30 years of experience in R&D and production of standard power supplies, MEAN WELL has ten product categories covering over 10,000 models, to provide "One Stop Shopping" power solutions. Every product in MEAN WELL is the result of rigid procedures governing design, design verification test (DVT), design quality test (DQT), component selection, pilot-run production, and mass production.

With more than 200 distributors globally, the MEAN WELL products are distributed to over 80 countries worldwide. The small size orders can expect delivery within 24 hours without MOQ requirement. If you are looking for switching power supply with high reliability, good quality, reasonable price and full series products, MEAN WELL, a total solution provider which can satisfy your various demands, is definitely your first choice!



MEAN WELL USA



MEAN WELL EUROPE

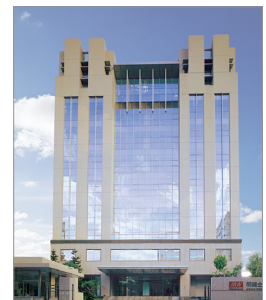

MEAN WELL TAIWAN

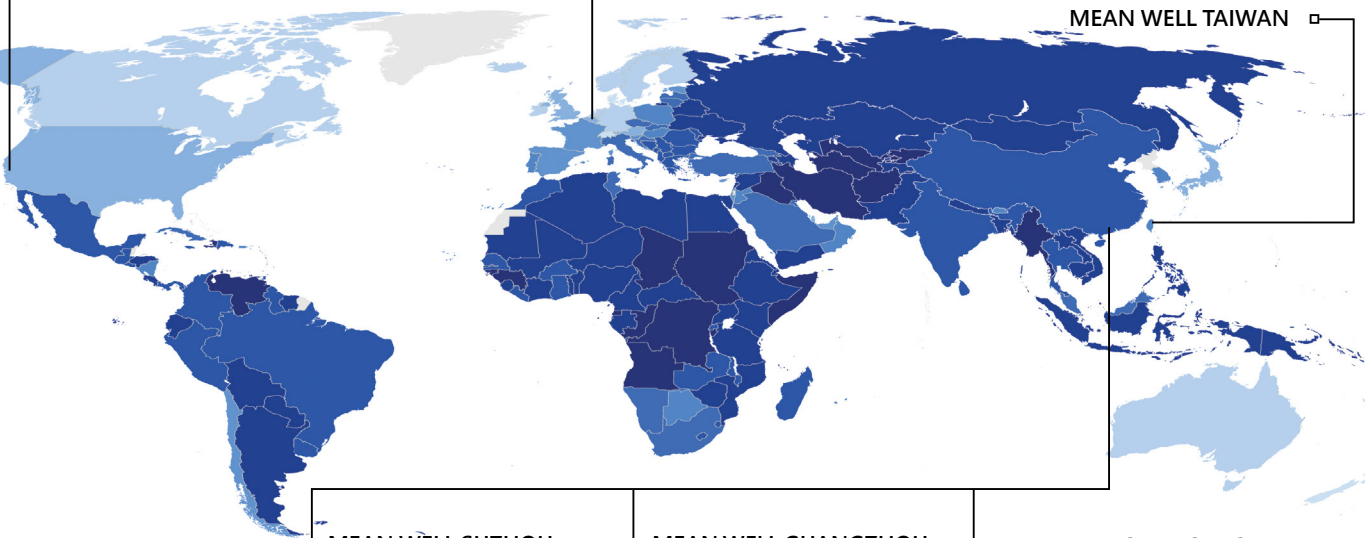

MEAN WELL SUZHOU

MEAN WELL GUANGZHOU
TIANHE R&D CENTER

MEAN WELL GUANGZHOU
HUADU FACTORY



Management System
ISO 9001:2015
ISO 14001:2015
ISO 45001:2018
www.tuv.com
ID 0091004832



KNX Introduction

What is KNX?

KNX is the only home and building control standard running global certification schemes.



The idea behind KNX is as simple as it is ingenious. KNX combines all main building functions like lighting, shutter control to heating, ventilation, security, energy management and more into one intelligent system. In this system, all devices communicate with one another via a single bus cable which is installed alongside the normal power lines. This means that all electrical functions are connected with one another via the bus system, which helps to lower operational costs resulting in considerable energy savings, to save installation time as well as to increase flexibility and adaptability to future developments.

Source: www.knx.org

Benefits

The MEAN WELL KNX system product is an intelligent solution for networking and controlling building technology. Since the targeted connections of devices and functions comply with the KNX standard, both living and working are not only becoming more convenient and secure, but also more energy-efficient and economical.



Indoor Lighting Control & Total Power Solution

The MEAN WELL KNX product range includes components covering the complete applications found in modern buildings, ranging from lighting and shutter control to heating, ventilation and many more. Furthermore, with over 35 years experience of the industrial power supply, MEAN WELL provides a variety of standard power supplies for all kinds of applications such as safety, surveillance, video, audio... etc.

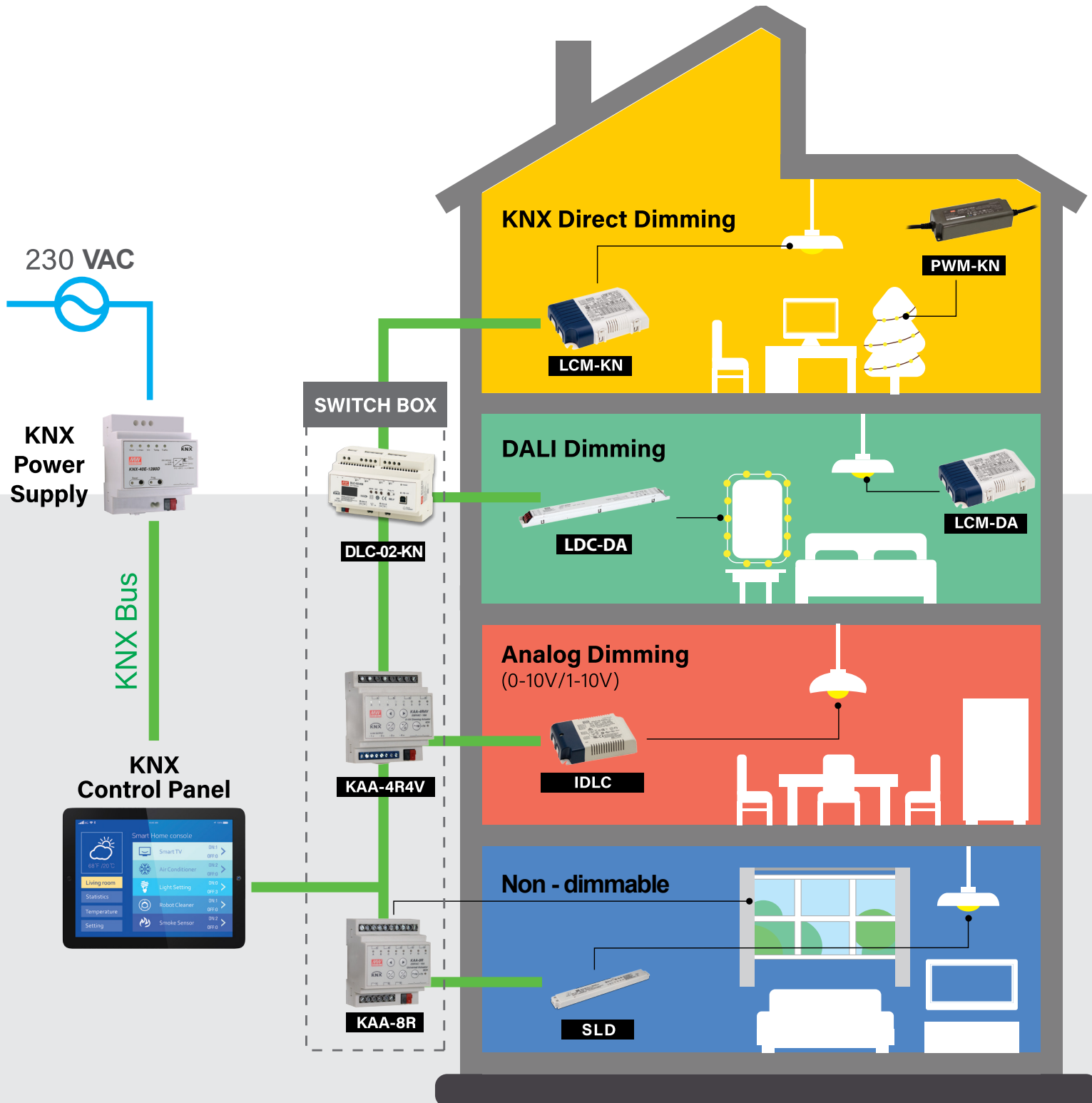

Product Tree

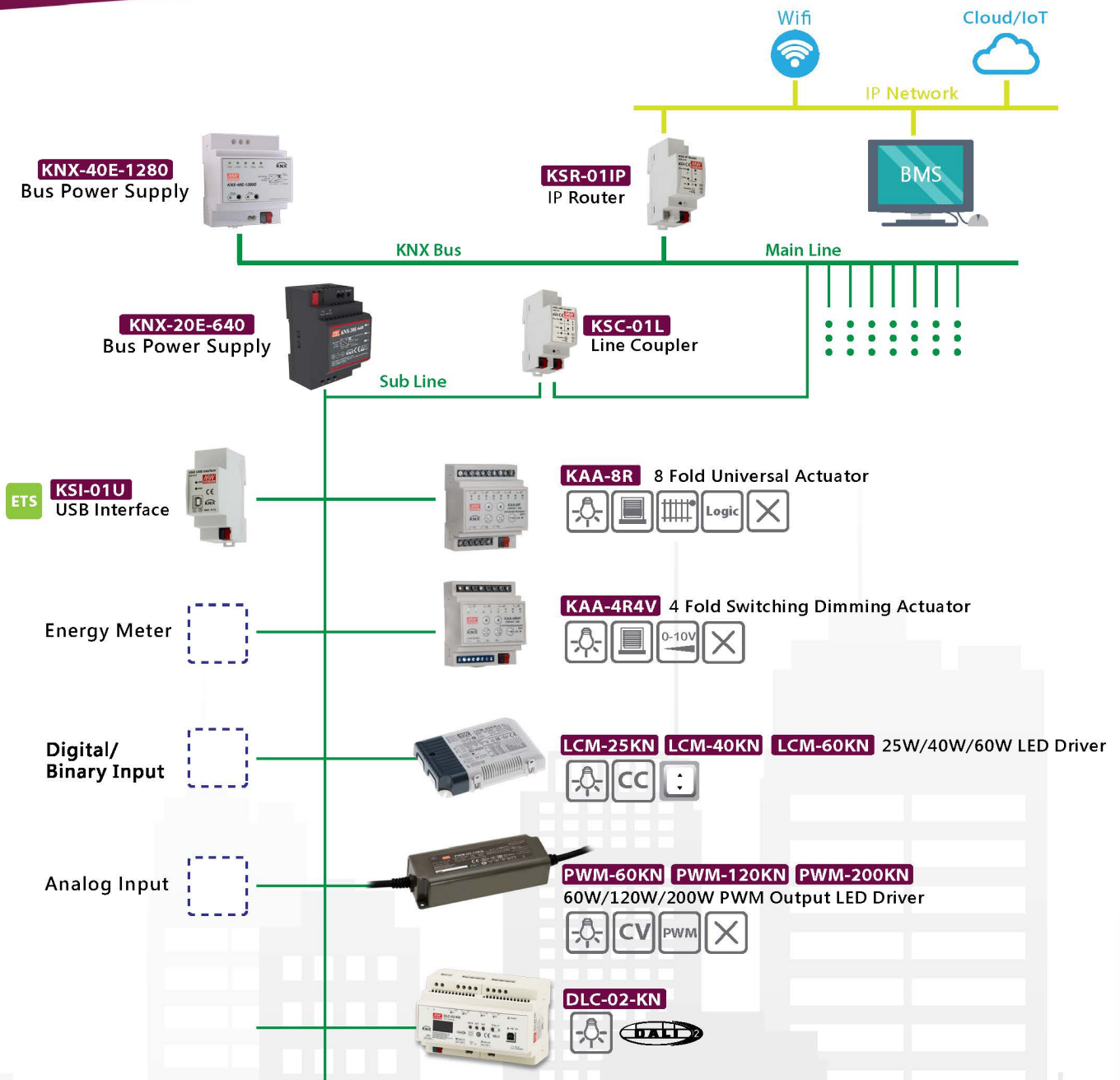

Under Planning	Blind/Shutter Control	Logic Function	Constant Current Driving Mode	DC 0-10V Dimming Control
Lighting Control	Heating Control	Push Button Interface	Constant Voltage Driving Mode	PWM Style Output Mode
Data Secure				



Fast and Multi Language Support for any question of KNX product within 24 hours .
For the details please check the last page.



LCM Series

25~60W KNX Constant Current LED Driver



LCM-KN series is an AC/DC constant current mode output LED driver series featuring the multiple levels selectable by dip switch and the KNX interface to avoid using the complicated KNX-DALI gateway. LCM-KN operates from 180~295VAC and offers different current levels ranging between 350mA and 1400mA.

Thanks to the high efficiency up to 90%, with the fanless design, the entire series is able to operate for -30°C~+90°C case temperature under free air convection. In addition, LCM-KN series is equipped with push dimming and synchronization so as to provide the optimal design flexibility for LED lighting system.



▲ LCM-25KN
L105x W68x H23mm



▲ LCM-40/60KN
L123.5x W81.5x H23mm

Features

- KNX protocol
- Constant current mode output with multiple levels selectable by dip switch
- Support emergency light (EL)
- Constant lumen output
- Intergrated KNX push button interface
- Synchronization up to 10 units
- Functions: manual dim, operation hours, log/linear curve selection
- 3 years warranty



■ LCM-25/40/60KN

Model No.	Output	Io Tol.	Io Ripple	Effi.
LCM-25KN	350mA~1050mA, 6~54V	±5%	5%(max)	86%
LCM-40KN	350mA~1050mA, 2~100V	±5%	5%(max)	90%
LCM-60KN	500mA~1400mA, 2~90V	±5%	5%(max)	91%

PWM Series

60~200W KNX Constant Voltage LED Driver



PWM-KN series is an AC/DC LED driver featuring the constant voltage mode with PWM style output controlled directly via KNX. The entire series is able to operate for -40°C~90 °C case temperature with its minimal dimming level low to 0.01% and user changeable output frequency up to 4KHz compliant IEEE 1789-2015 flickering requirement.



Features

- KNX protocol
- Constant Voltage PWM style output with user changeable frequency up to 4KHz
- Plastic housing with class II design
- Built-in active PFC function
- Standby power consumption <0.5W
- Typical lifetime >50000 hours
- Support KNX data secure (PWM-200KN only)
- Minimum dimming level 0.01%
- 5 years warranty



■ PWM-60/120/200KN

Model No.	Output	Tol.	Effi.
PWM-60-12□	12V, 0~5A	±4%	86%
PWM-60-24□	24V, 0~2.5A	±3%	89%
PWM-120-12□	12V, 0~10A	±4%	88%
PWM-120-24□	24V, 0~5A	±4%	90%
PWM-200-12□	12V, 0~15A	±4%	92%
PWM-200-24□	24V, 0~8.3A	±3%	93%
PWM-200-36□	36V, 0~5.5A	±3%	94%
PWM-200-48□	48V, 0~4.17A	±3%	94%

□=KNX/KNBST KN: KNX control technology ; KNBST: KNX control technology with BST14 connector

KAA Series

KNX Actuator



KNX Universal Actuator

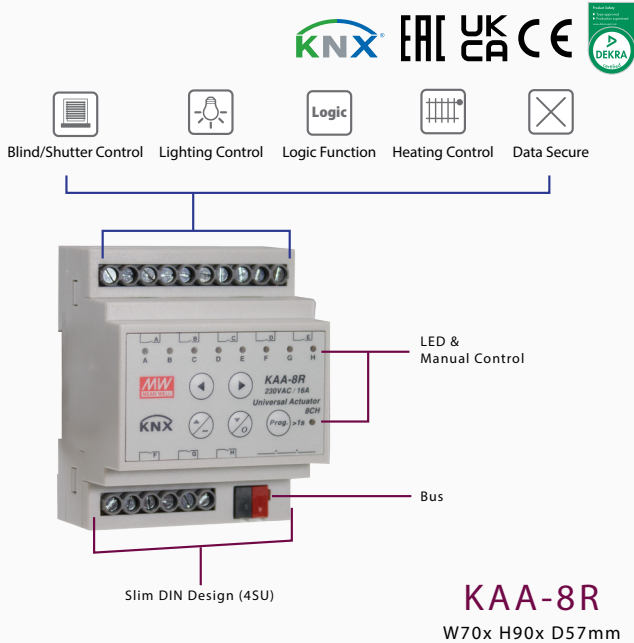

Features

- 8 channel actuator in a compact size
- Suitable for various and mixed applications
- For AX, C-load, capacitive & inductive of loads
- **Capacitive load 220µF**
- Manual control via panel push button
- KNX data secure version available
- 3 years warranty

Model No.	Channel	Rating Current / Channel
KAA-8R	8-Fold	16A
KAA-8R-10	8-Fold	10A

KNX Dimming Actuator



Features

- Dimming and switching LED driver and conventional electronic ballast
- **Capacitive load 220µF**
- Linear or logarithmic dimming curve programmable via ETS software
- Programmable various time and scene function
- KNX data secure version available
- 3 years warranty

Model No.	Channel	Rating Current / Channel
KAA-4R4V	4-Fold	16A
KAA-4R4V-10	4-Fold	10A

KAA-4R4V Wiring Examples

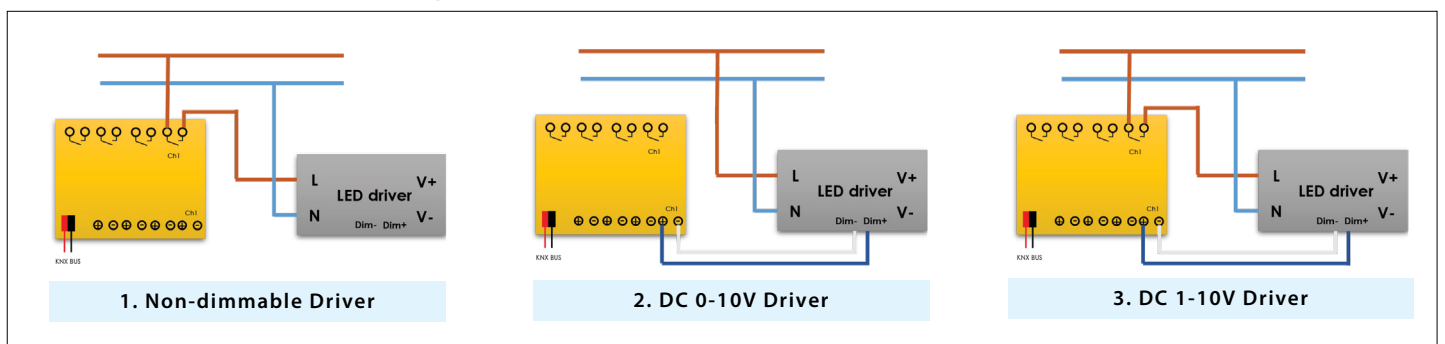

KNX Series

640mA & 1280mA Bus Power Supply

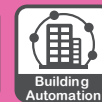

640mA Bus Power Supply

KNX-20E-640 is a 640mA power supply with high efficiency and a small footprint of only 3SU (52.5 mm). The device has a KNX bus choke output and an additional output for ancillary power. LED indicators are used in normal operation, overload conditions and RESET operation. It is perfectly suitable to power up any products labeled with the KNX trademark. KNX-20E-640 is engineered to be a reliable and safe solution for KNX bus environment.



1280mA Bus Power Supply

KNX-40E-1280 is a 1280mA power supply with high efficiency and a small footprint of only 4SU(72mm). The device has a KNX bus choke output and an additional output for ancillary power. LED indicators are used in normal operation, overload conditions and RESET operation. It is perfectly suitable to power up any products labeled with the KNX trademark. KNX-40E-1280 is engineered to be a reliable and safe solution for KNX bus environment.



Features

- EIB / KNX power supply with integrated choke
- Compact size with 3SU/4SU width
- Safety extra low voltage (SELV)
- 180~264VAC input
- No load power consumption <0.5W
- Protections:
Short circuit / Overload(short-circuit-proof) / Over voltage

- Cooling by free air convection
- Isolation class I
- LED indicator for normal operation, bus reset and bus overload
- Installed on DIN rail TS-35/7.5 or 15
- Over voltage category III
- Wide operating temperature: -30~+70°C

Model No.	V _{out1} (with choke)	V _{out2} (without choke)	I _{out} (I ₁ +I ₂)
KNX-20E-640	Bus, 30VDC	30VDC	640mA

Model No.	V _{out1} (with choke)	V _{out2} (without choke)	I _{out} (I ₁ +I ₂)
KNX-40E-1280 <input type="checkbox"/>	Bus, 30VDC	30VDC	1280mA

: Blank, D ; Blank= Basic function, D=Diagnostic function

Gateway System Component



KNX to DALI Gateway/Controller



DLC-02-KN
L140x W90x H58.4mm

Features

- KNX to DALI-2 gateway
- Two independent DALI Bus channels with built-in bus power supply (up to 250mA per bus)
- Connect up to 2x64 DALI ECGs/Drivers
- LCD display, LED indicators and buttons for local operation
- Built-in 4x250/5A relay
- Easy installation and configuration via PC software
- Data backup and restoring, control via web browser

How to use DLC-02

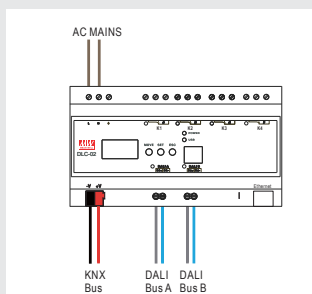

KNX gateway

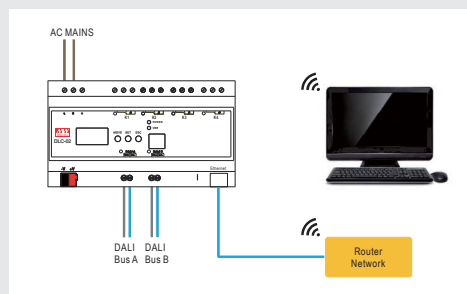

Commissioning the DLC-02 via web browser

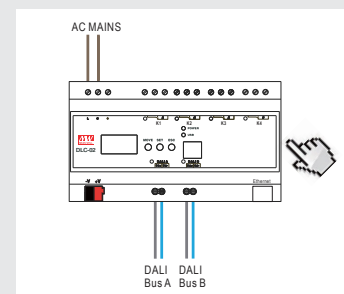

Local setting

USB Interface



KSI-01U
W36x H90x D71mm

Features

- No additional power supply required
- KNX commissioning, addressing and parameters settings
- Long messages support up to 220 byte APDU
- 3 years warranty

IP Router



KSR-01IP
W36x H90x D71mm

Features

- KNX IP/TP routing
- Built-in web server
- KNX IP secure (optional)
- 3 years warranty

Line Coupler



KSC-01L
W36x H90x D71mm

Features

- KNX TP Line coupler/Repeater
- Telegram filtering function
- Long messages support up to 240 byte APDU
- 3 years warranty

HDR Series

15~150W Ultra Slim Step Shape Power Supply



Features

- Ultra slim design with 15U~6SU width
- Universal input 85~264VAC(277VAC operational)
- No load power consumption<0.3W
- Isolation class **II**
- Pass LPS (Limited power source)
- DC output voltage adjustable
- Protections : Short circuit / Overload / Over voltage
- Cooling by free air convection (working temperature:-30~+70°C)
- DIN rail TS-35/7.5 or 15 mountable
- Over voltage category **III**
- LED indicator for power on
- 3 years warranty



▲HDR-15
L17.5x W90x D54.5mm



▲HDR-30
L35x W90x D54.5mm



▲HDR-60
L52.5x W90x D54.5mm



▲HDR-100
L70x W90x D54.5mm



▲HDR-150
L105x W90x D54.5mm

■ HDR-15

Model No.	Output	Tol.	R&N	Effi.
HDR-15-5	5V, 0~2.40A	±2%	80mV	80%
HDR-15-12	12V, 0~1.25A	±1%	120mV	85%
HDR-15-15	15V, 0~1.00A	±1%	120mV	85.5%
HDR-15-24	24V, 0~0.63A	±1%	150mV	86%
HDR-15-48	48V, 0~0.32A	±1%	240mV	87%

■ HDR-30

Model No.	Output	Tol.	R&N	Effi.
HDR-30-5	5V, 0~3.0A	±2%	80mV	82%
HDR-30-12	12V, 0~2.0A	±1%	120mV	88%
HDR-30-15	15V, 0~2.0A	±1%	120mV	89%
HDR-30-24	24V, 0~1.5A	±1%	150mV	89%
HDR-30-48	48V, 0~0.75A	±1%	240mV	90%

■ HDR-60

Model No.	Output	Tol.	R&N	Effi.
HDR-60-5	5V, 0~6.5A	±2%	80mV	85%
HDR-60-12	12V, 0~4.5A	±1%	120mV	88%
HDR-60-15	15V, 0~2.0A	±1%	120mV	89%
HDR-60-24	24V, 0~1.5A	±1%	150mV	90%
HDR-60-48	48V, 0~0.75A	±1%	240mV	91%

■ HDR-100

Model No.	Output	Tol.	R&N	Effi.
HDR-100-12	12V, 0~7.1A	±2%	120mV	88%
HDR-100-12N	12V, 0~7.5A	±2%	120mV	88%
HDR-100-15	15V, 0~6.13A	±1%	120mV	89%
HDR-100-15N	15V, 0~6.5A	±1%	120mV	89%
HDR-100-24	24V, 0~3.83A	±1%	150mV	90%
HDR-100-24N	24V, 0~4.2A	±1%	150mV	90%
HDR-100-48	48V, 0~1.92A	±1%	240mV	90%
HDR-100-48N	48V, 0~2.1A	±1%	240mV	90%

HDR-100: 92W max., pass LPS
 HDR-100-xxN: 100W max., non-LPS with a wide output adjustable range

■ HDR-150

Model No.	Output	Tol.	R&N	Effi.
HDR-150-12	12V, 0~11.3A	±2%	100mV	89%
HDR-150-15	15V, 0~9.5A	±1%	120mV	89.5%
HDR-150-24	24V, 0~6.25A	±1%	150mV	90.5%
HDR-150-48	48V, 0~3.2A	±1%	200mV	90.5%

Taiwan (Headquarters)

MEAN WELL ENTERPRISES CO., LTD.

No. 28, Wuquan 3rd Road, Wugu District,

New Taipei City, Taiwan, 24891

Tel +886-2-2299-6100(rep.)

Fax +886-2-2299-6200(rep.) +886-2-2298-0818(sales)

e-mail info@meanwell.com

Web www.meanwell.com

U.S.A.

MEAN WELL USA, INC.

44030 Fremont Blvd., Fremont, CA 94538, U.S.A.

Tel +1-510-683-8886

Fax +1-510-683-8899

e-mail info@meanwellusa.com **Web** www.meanwellusa.com

Europe

MEAN WELL EUROPE B.V.

Langs de Werf 8, 1185XT Amstelveen, the Netherlands

Tel +31-20-758-6000

Fax +31-20-758-6001

e-mail info@meanwell.eu **Web** www.meanwell.eu

China

MEAN WELL (GUANGZHOU) ELECTRONICS CO., LTD.

No.11, Jingu South Road, Huadong Town, Huadu District,

Guangzhou, Guangdong, China

Tel +86-20-3773-7100 / 400-800-3608(sales)

+86-10-5200-1817(Beijing Office)

+86-755-2359-1630(Shengzhen Office)

R&D Center

2F, A Building, Yuean Industry Park, Huangcun,

Dongpu Town, Tianhe District, Guangzhou, China

Post Code: 510660

Tel +86-20-2887-1200(rep.)

Fax +86-20-8201-0507

e-mail info@meanwell.com.cn **Web** www.meanwell.com.cn

SUZHOU MEAN WELL TECHNOLOGY CO., LTD.

No.77, Jian-Min Rd. Dong-Qiao, Pan-Yang Ind. Park, Huang-Dai

Town, Xiang-Cheng District, Suzhou, Jiang-Su, China

Tel +86-512-6508-8600

Fax +86-512-6508-8700

e-mail info@meanwell.cc **Web** www.meanwell.cc



info@meanwell.com
www.meanwell.com
building.meanwell.com

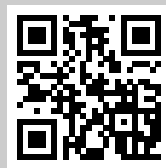

For service, repairs and telephone support, you can talk to one of our in-house employees. This ensures that you receive specialist advice. You won't simply end up in a call center!

中文 任何KNX 產品疑問24小時內快速回覆

简体中文 任何KNX 产品疑问24小时内快速回复

GERMAN Schneller Support für jegliche KNX-Produkt Fragen innerhalb von 24 Stunden.

ENGLISH Fast support for any question of KNX Product within 24 hours.

FRENCH Assistance rapide pour toute question relative aux produits KNX en 24 heures maximum.

SPANISH Soporte rápido para cualquier pregunta de los productos KNX en 24 horas.

DUTCH Wij bieden snelle ondersteuning voor al uw KNX-productvragen binnen 24 uur.

ITALIAN Supporto rapido per qualsiasi richiesta sui nostri prodotti KNX entro 24 ore.

POLISH Szybkie wsparcie dla dowolnego pytania dotyczącego produktu KNX w ciągu 24 godzin.

