

AMP SUPERSEAL 1.5 Series Connectors

for the Automotive Industry

INNOVATIVE TECHNOLOGIES

TE Connectivity (TE) is a leader in automotive connectivity and sensor technology. Our engineers are always working to meet complex requirements. We connect nearly every electronic function in the vehicle - from alternative power systems to infotainment and sensor technologies. Our technologies withstand harsh environments and tolerate high temperature, vibration, shock, pressure and long-life in electronic control systems.



INTERCONNECTION SYSTEMS

Our electrical and electronic interconnection products and solutions are used to electrically and mechanically connect wires and cables, printed circuit boards, integrated circuit packages, batteries and more.



CABLE ASSEMBLIES

TE is your partner for vehicle-specific cable assemblies. We offer research and development capabilities, prototypes and samples, as well as manufacturing facilities.



HYBRID & ELECTRIC MOBILITY SOLUTIONS

Our technologies leverage decades of innovation and experience with high-voltage transmission and distribution. Our hybrid and electric mobility solutions include a complete line of connectors, terminals, sensors, cable assemblies, contactors, and battery connection protection to help safeguard the flow of power in hybrid and electric vehicles. Connection after connection, you can count on TE for smaller, greener, lighter and smarter solutions you can trust.



SENSOR SOLUTIONS

Data is critical for making vehicles safer, greener, smarter and more connected. Customers rely on our sensor technology to provide data for control, adaptation and response of vehicle functions and features that increase safety, comfort, efficiency, and more. We collaborate to provide solutions for demanding and harsh applications such as automated transmissions, engines, chassis, clutch, brake and exhaust. Our products can be found in vehicles traveling the world's roads and highways.







INFOTAINMENT





Our wide range of infotainment solutions are ideal for consumer port connections, high data rate applications, next-generation harness architecture, board-to-board connections and vehicle-to-vehicle communication.

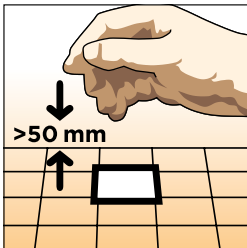

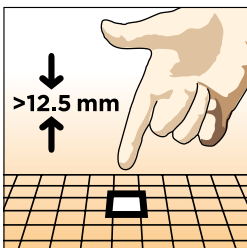
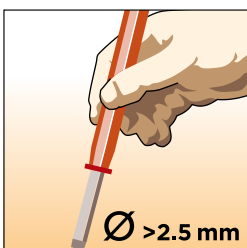
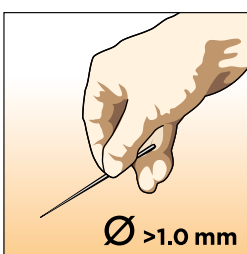
RELAYS

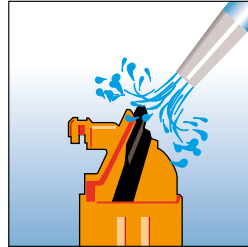
From passenger comfort and infotainment to higher DC voltages and power levels to harsh environments, our relays and contactors provide critical switching functions in multiple vehicle applications. With increased contact gaps and other key design features, our relays are ideal for harsh environments such as shock and vibration.

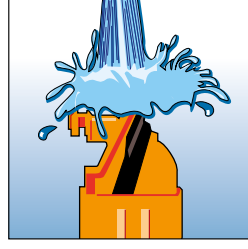
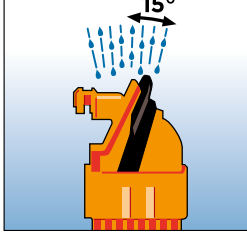
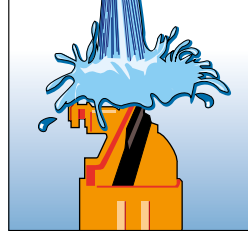
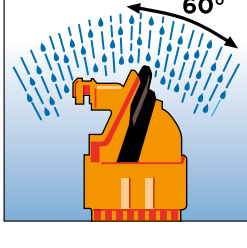
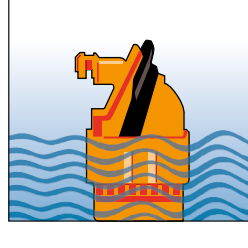
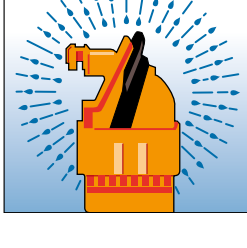
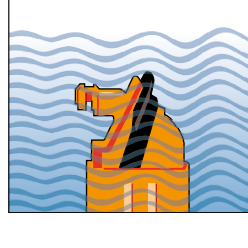
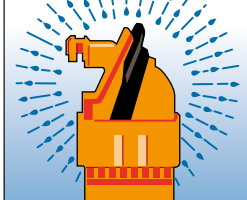
1st Digit Against Foreign Objects (incl. Dust)	1st Digit Against Foreign Objects (incl. Dust)
<p>0</p>  <p>Not protected.</p>	<p>5K</p>  <p>Dust protected.</p>
<p>1</p>  <p>Protected against solid objects greater than 50 mm (ex. back of hand).</p>	<p>6K</p>  <p>Dust tight.</p>
<p>2</p>  <p>Protected against solid objects greater than 12.5 mm (ex. finger).</p>	
<p>3</p>  <p>Protected against solid objects greater than 2.5 mm (ex. tool).</p>	
<p>4</p>  <p>Protected against solid objects greater than 1.0 mm (ex. wire).</p>	

2nd Digit	Against Water	2nd Digit	Against Water
0	 <p>Not protected.</p>	5	 <p>Protected against jetting water.</p>
1	 <p>Protected against vertically dripping water.</p>	6	 <p>Protected against powerfully jetting water.</p>
2	 <p>Protected against dripping water when tilted up to 15°.</p>	6K	 <p>Protected against powerfully jetting water with increased pressure (Automotive).</p>
3	 <p>Protected against spraying water (up to 60° inclination).</p>	7	 <p>Protected against the temporary effects of immersion up to 1 meter.</p>
4	 <p>Protected against splashing water.</p>	8	 <p>Protected against continuous submersion agreed with customer, but more severe than code 7.</p>
4K	 <p>Protected against splashing water with increased pressure.</p>	9K	 <p>Protected against high-pressure/steam-jet cleaning (Automotive).</p>

Good Crimp Quality

<p>Bellmouth permissible</p> <p>Bellmouth must always be present</p> <p>Cut-off tab present</p>	<p>F-CRIMP</p>	<p>Crimp barrel closed</p> <p>Insulation is securely held</p>
<p>Insulation visible</p> <p>Conductor visible</p> <p>Locking lances and terminal body not deformed</p>	<p>OVERLAP CRIMP</p>	<p>Crimp legs overlap</p> <p>Insulation is securely held</p>
<p>Anvil imprint symmetrical</p>	<p>WRAP OVER CRIMP</p>	<p>Crimp legs must pass each other</p> <p>Insulation is securely held</p>
<p>Correct selection</p> <p>of wire, terminal and applicator</p> <p>Crimp barrel is closed, legs support each other, sufficient gap between legs and bottom of crimp, all strands are equally distributed and deformed</p>		

Test

WIRE CRIMP

Crimp heights and tolerances

For crimp height tolerances for any given contact, please refer to the relevant application specification.

Examples

Contact	P/N	Wire Range	Tolerance	Spec.
JJPT	927775	0.50-1.00 mm ²	±0.05 mm	114-18050
JPT	927773	1.50-2.50 mm ²	±0.05 mm	114-18050
MQS	962885	0.20-0.50 mm ²	±0.03 mm	114-18025

INSULATION CRIMP

Wire crimp without conductor

Insulation must be securely held after bend test (one bend cycle)

WIRE CRIMP

Digital crimp height micrometer (0.001 mm increments) according to DIN ISO 9001
Part number: 547203-1

Incorrect Crimp Quality

<p>Terminal body damaged</p>	<p>F-CRIMP</p>	<p>Crimp legs are not closed</p> <p>Insulation is pierced</p>
<p>Single core crimped on terminal</p>	<p>INSULATION CRIMP OVERLAP CRIMP</p>	<p>Crimp legs do not overlap</p> <p>Insulation is pierced</p>
<p>Terminal twisted</p>	<p>WRAP OVER CRIMP</p>	<p>Insulation is not securely held</p> <p>Insulation is over crimped</p>
<p>Cut off tab too long</p>	<p>Conductor brush protrudes into terminal body</p> <p>Insulation inside the wire crimp</p>	
<p>Crimp barrel distorted</p>	<p>Wire bent</p>	
<p>Terminal bent</p>	<p>Terminal bent</p>	

Correct
Incorrect
Test

At TE Connectivity, we support your RoHS requirements. We've assessed more than 1.5 million end items/components for RoHS compliance, and issued new part numbers where any change was required to eliminate the restricted materials. Part numbers in this catalog are identified as:

RoHS Compliant

Part numbers in this catalog are RoHS Compliant, unless marked otherwise. These products comply with European Union Directive 2002/95/EC as amended 1 January 2006 that restricts the use of lead, mercury, cadmium, hexavalent chromium, PBB, and PBDE in certain electrical and electronic products sold into the EU as of 1 July 2006.

Note: For purposes of this Catalog, included within the definition of RoHS Compliant are products that are clearly "Out of Scope" of the RoHS Directive such as hand tools and other non-electrical accessories.

Non-RoHS Compliant

These part numbers are identified with a "t" symbol. These products do not comply with the material restrictions of the European Union Directive 2002/95/EC.

5 of 6 Compliant

A "l" symbol identifies these part numbers. These products do not fully comply with the European Union Directive 2002/95/EC because they contain lead in solderable interfaces (they do not contain any of the other five restricted substances above allowable limits). However, these products may be suitable for use in RoHS applications where there is an application-based exception for lead in solders, such as the server, storage, or networking infrastructure exemption.

Note: Information regarding RoHS compliance is provided based on reasonable inquiry of our suppliers and represents our current actual knowledge based on the information provided by our suppliers. This information is subject to change. For latest compliance status, refer to our website referenced below. So whatever your questions when it comes to RoHS, we've got the answers at <http://www.TE.com/customersupport/rohssupportcenter/>

Getting the information you need

Our comprehensive on-line RoHS Customer Support Center provides a forum to answer your questions and support your RoHS needs. A RoHS FAQ (Frequently Asked Questions) is available with links to more detailed information. You can also submit RoHS questions and receive a response within 24 hours during a normal work week. The Support Center also provides:

- Cross-Reference from Non-compliant to Compliant Products
- Ability to browse RoHS Compliant Products in our on-line catalog:
www.TE.com/commerce/alt/RohsAltHome.do
- Downloadable Technical Data Customer Information Presentation
- More detailed information regarding the definitions used above

Conversion Tables
AWG Conversion Table (Average Value)

AWG Code	Diameter (Inch)	Diameter (mm)	F (mm ²)
000000	0.5800	14.733	170.0
00000	0.5165	13.13	135.0
0000	0.4600	11.684	103.8
000	0.4096	10.40	79.0
00	0.3648	9.27	67.5
0	0.3249	8.25	53.4
1	0.2893	7.34	42.2
2	0.2576	6.55	33.7
3	0.2294	5.82	26.6
4	0.2043	5.18	21.0
5	0.1819	4.62	16.9
6	0.1620	4.115	13.25
7	0.1443	3.66	10.25
8	0.1285	3.26	8.34
9	0.1144	2.90	6.6
10	0.1019	2.59	5.27
11	0.0907	2.30	4.15
12	0.0808	2.05	3.3
13	0.0720	1.83	2.63
14	0.0641	1.63	2.08
15	0.0571	1.45	1.65
16	0.0508	1.29	1.305
17	0.0453	1.14	1.01
18	0.0403	1.02	0.79
19	0.0359	0.91	0.65
20	0.0320	0.81	0.51
21	0.0285	0.72	0.407
22	0.0253	0.64	0.32
23	0.0226	0.57	0.255
24	0.0201	0.51	0.205
25	0.0179	0.455	0.162
26	0.0159	0.40	0.125
27	0.0142	0.36	0.102
28	0.0126	0.320	0.08
29	0.0113	0.287	0.0646
30	0.0100	0.254	0.0516
31	0.0089	0.226	0.04
32	0.0080	0.203	0.0324
33	0.0071	0.180	0.0255
34	0.0063	0.160	0.02
35	0.0056	0.142	0.0158
36	0.0050	0.127	0.0127
37	0.0045	0.114	0.01
38	0.0040	0.101	0.008
39	0.0035	0.089	0.0062
40	0.0031	0.079	0.0049
41	0.0028	0.071	0.00395
42	0.0025	0.064	0.00321
43	0.0022	0.056	0.00246
44	0.00198	0.050	0.00196
45	0.00176	0.045	
46	0.00157	0.040	
47	0.00140	0.036	
48	0.00124	0.031	
49	0.00110	0.028	
50	0.00099	0.025	

Remark: Starting from 0.03 mm² (AWG 32) a wire can be crimped.

**AMP SUPERSEAL 1.5
 Series Connectors**

	Page	Powertrain Systems	Safety & Security Systems	Convenience	Driver Information	Body & Chassis Systems
AMP SUPERSEAL 1.5 Series Connectors						
Introduction	1					
1.5 mm Receptacle Contacts	2	•	•	•	•	•
1.5 mm Tab Contacts	3	•	•	•	•	•
Single Wire Seals and Cavity Plug	4	•	•	•	•	•
Plug Housings, 1 - 6 Positions	5	•	•	•	•	•
Cap Housings, 1 - 6 Positions	6	•	•	•	•	•
Rubber Boots	7	•	•	•	•	•
Application Tooling	9					
Numerical Index	10					
TE Connectivity online	12					
Global Contacts	13					
Imprint	13					

POWERTRAIN SYSTEMS



SAFETY & SECURITY SYSTEMS



CONVENIENCE



DRIVER INFORMATION



BODY & CHASSIS SYSTEMS



AMP SUPERSEAL 1.5 SERIES CONNECTORS

INTRODUCTION

TE Connectivity has developed the AMP SUPERSEAL 1.5 series connector family to meet the increasing requirements for reliability and water proofness.

AMP SUPERSEAL 1.5 series connector exceed the requirements prescribed by IP 67 according IEC 60529 and DIN 40050-9 standards and has its application in the automotive, agriculture and industrial machinery.

For sensor application the AMP SUPERSEAL 1.5 series Connector system is qualified as well.

Advantages

- Compact system minimizes packaging requirements
- Sealing reliability proven under harsh conditions
- Designed for ease of manual harness assembly, engine mounting and under hood environments

Applications

- Wire-to-Wire (1.5 mm) and ECU applications, under hood or any location where sealing is required
- Suitable for automotive, truck, bus, or off-road vehicles



Application Tooling Note

For further information please visit <http://www.te.com/products/application-tooling.html> for our Search Function.



AMP SUPERSEAL 1.5 Series Connectors

1.5 mm Receptacle Contacts

1.5 mm Receptacle Contacts

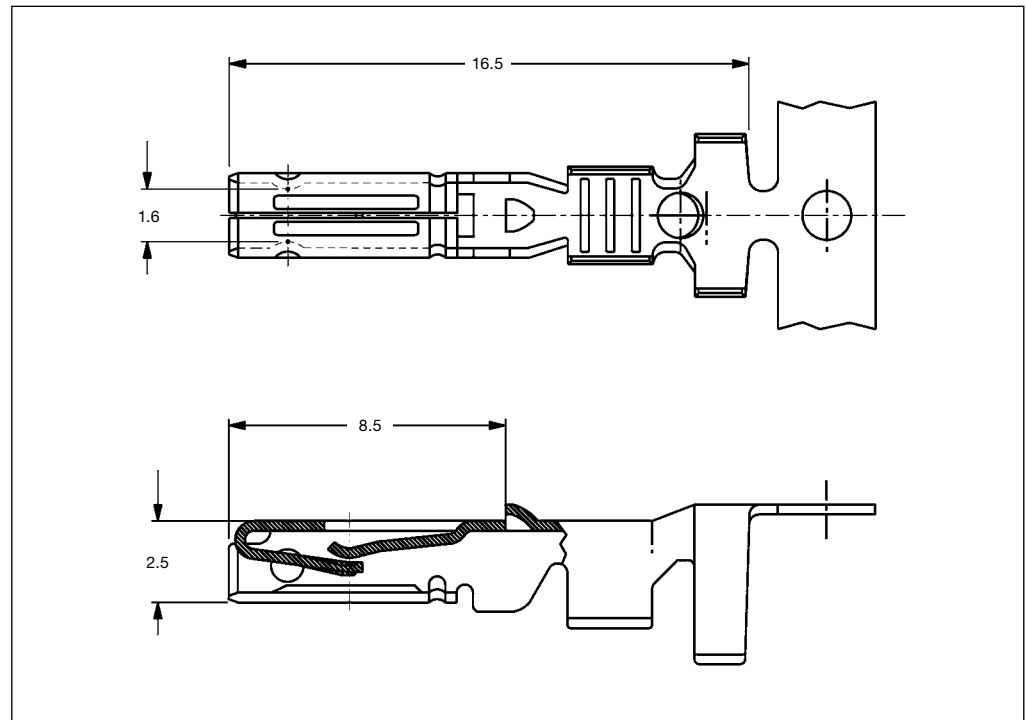
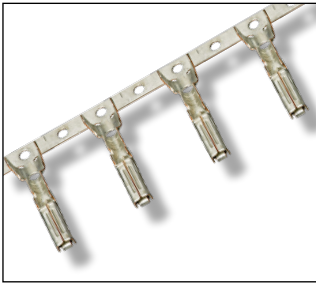

Technical Features

Contact Finish:

Tin plated

Current Carrying Capacity:

14 A max.

Wire Size Range:

0.35 – 2.5 mm²

Insulation Diameter:

1.2 – 3.3 mm FLR

Extraction Tool:

Part No. 9-1579007-1

Product Specification:

108-20090

Application Specification:

114-20045

1.5 mm Receptacle Contacts

Wire Size Range (mm ²)	Insulation Diameter (mm)		Material and Finish	Part Numbers		
	FLK	FLR		Strip Form	Applicator	Hand Tool
0.35 – 0.50	1.45 – 2.20	1.2 – 1.6	CuSn, tin plated	282403-1	2151734-2 / 2266249-2 *)	Hand Tool Frame 539635-1 Die-Set 539773-2
0.75 – 1.50	2.40 – 3.35	1.7 – 2.4		282110-1	2151205-2 / 2266053-2 *)	58583-1
1.50 – 2.50	3.15 – 3.80	2.2 – 3.3		282466-1	2151856-2	–

*) Use in Stripper Seal Crimp Terminator

1.5 mm Tab Contacts

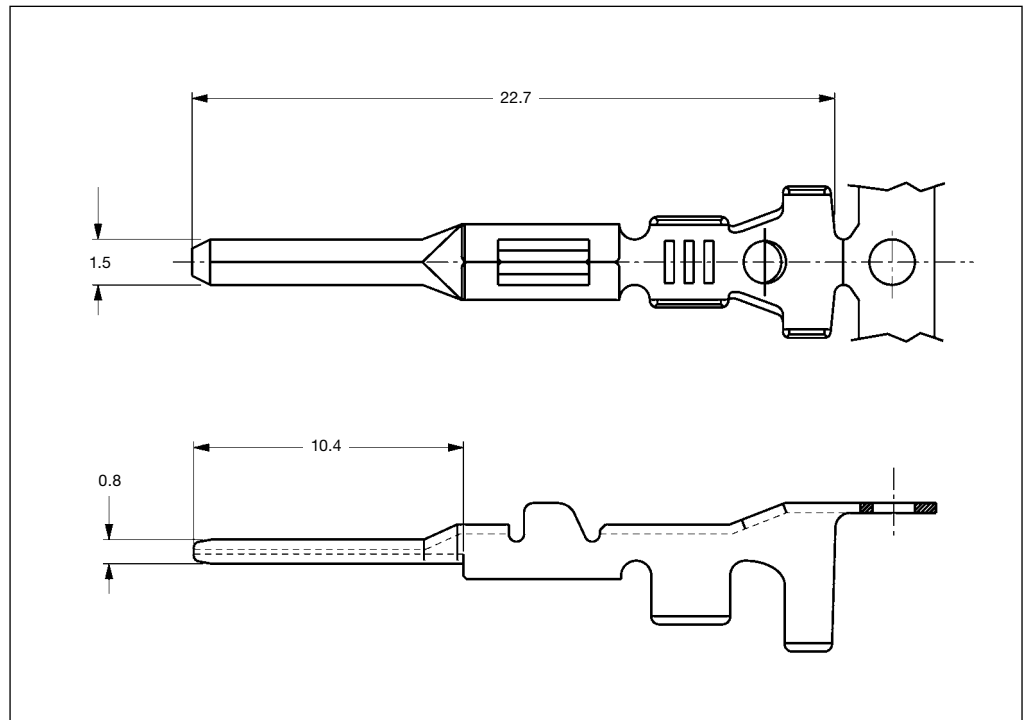
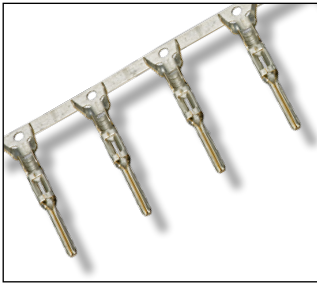

Technical Features

Contact Finish:

Tin plated, gold plated

Current Carrying Capacity:

14 A max.

Wire Size Range:

0.35 – 2.5 mm²

Extraction Tool:

Part No. 9-1579007-1

Product Specification:

108-20090

Application Specification:

114-20045

1.5 mm Tab Contacts

Wire Size Range (mm ²)	Insulation Diameter (mm)		Material and Finish	Part Numbers		
	FLK	FLR		Strip Form	Applicator	Hand Tool
0.35 – 0.50	1.45 – 2.20	1.2 – 1.6	CuZn, tin plated	282404-1	2151855-2	Hand Tool Frame 539635-1 Die Set 539773-2
			CuZn, gold plated	282404-3		
0.75 – 1.50	2.40 – 3.35	1.7 – 2.4	CuZn, tin plated	282109-1	2151204-2 / 2266068-2 *)	58583-1
			CuZn, gold plated	282109-3		
1.50 – 2.50	3.15 – 3.80	2.2 – 3.3	CuZn, tin plated	282465-1	2266253-2	–

*) Use in Stripper Seal Crimp Terminator

Single Wire Seals and Cavity Plug

Technical Features

- Made from silicon rubber material
- For insulation diameters of 1.2 – 3.3 mm
- Loose-piece wire seals are crimped simultaneously with the contacts

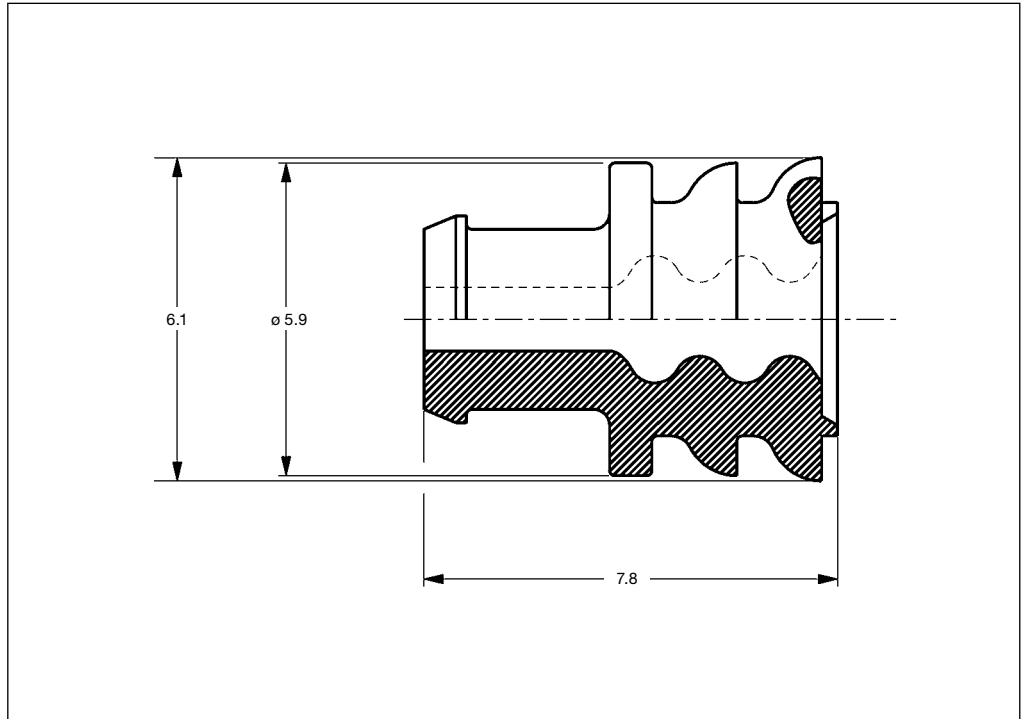

Single Wire Seals and Cavity Plug

Insulation Diameter (mm)	Color	Part Number
1.2 – 1.6	Green	281934-4
1.7 – 2.4	Yellow	281934-2
2.5 – 3.3	Red	281934-3
Cavity Plug	Red	282081-1

AMP SUPERSEAL 1.5 Series Connectors Plug Housings

Plug Housings (utilizes Receptacle Contacts)



1 to 6 positions



Technical Information

Product Specification:
 108-20090

Application Specification:
 412-20000

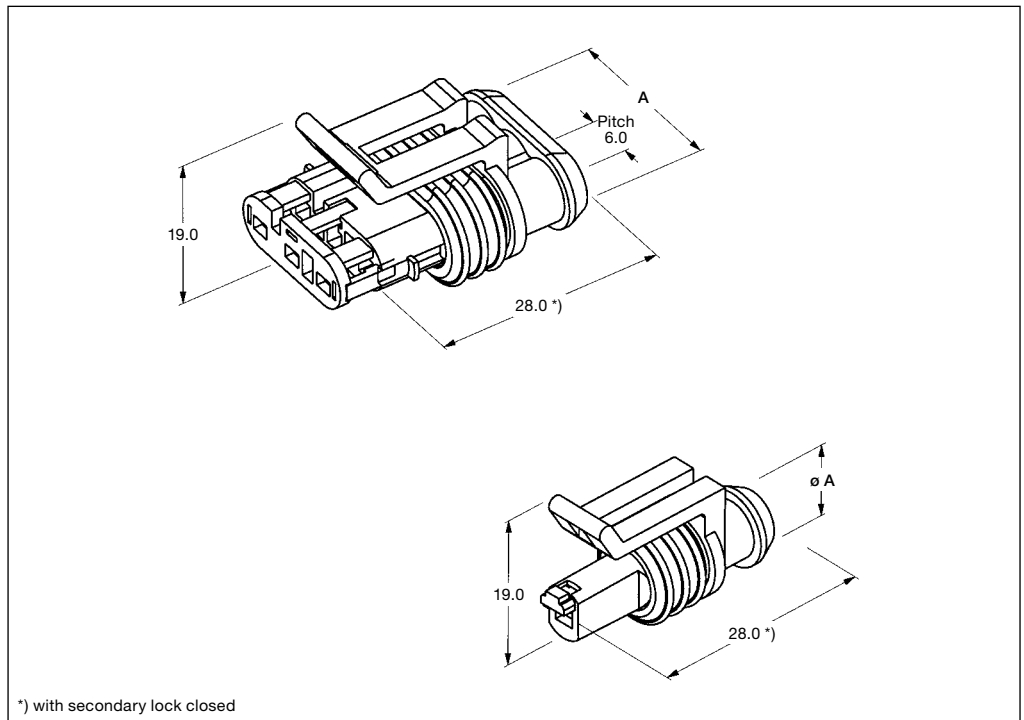

Plug Housings

No. of Positions	Dimension A (mm)	Part Number
1	9.3	282079-2
2	15.3	282080-1
3	21.3	282087-1
4	27.3	282088-1
5	33.3	282089-1
6	39.3	282090-1

AMP SUPERSEAL 1.5 Series Connectors Cap Housings

Cap Housings (utilizes Tab Contacts)



1 to 6 positions



Technical Information

**Extraction Tool
 for Secondary Lock
 of Cap Housing:**
 Part No. 785084-1

**Insertion Tool
 for Secondary Lock
 of Cap Housing:**
 Part No. 785061-1
 for 1 and 2 positions
 Part No. 785061-2
 for 3 – 6 positions

Product Specification:
 108-20090

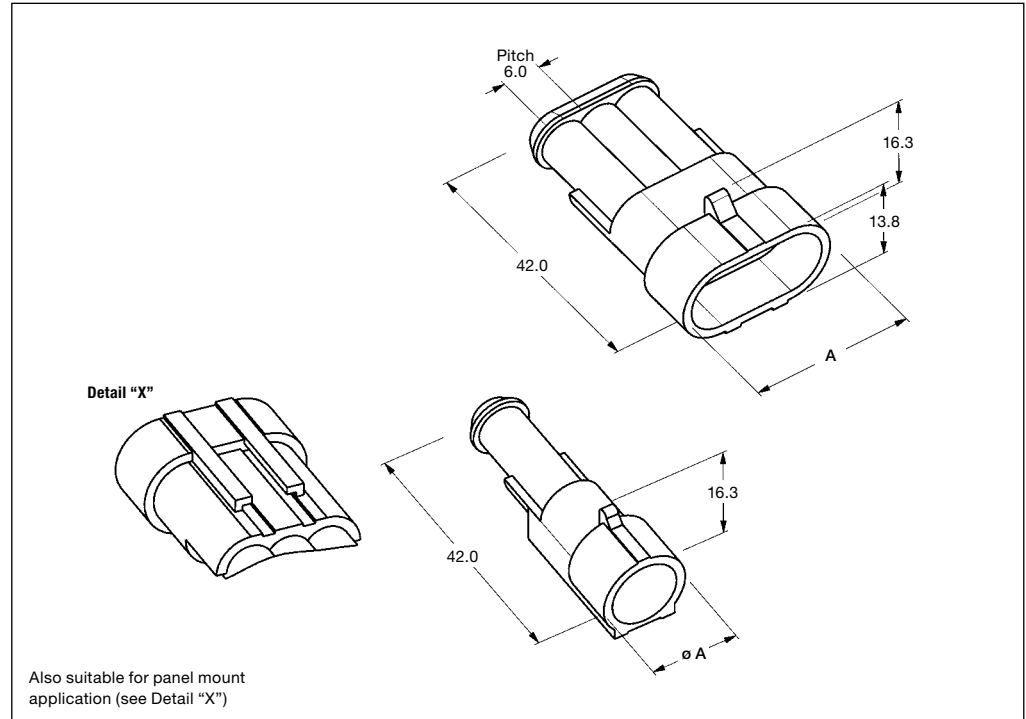

Cap Housings

No. of Positions	Dimension A (mm)	Part Number
1	13.8	282103-1
2	19.8	282104-1
3	25.8	282105-1
4	31.8	282106-1
5	37.8	282107-1
6	43.8	282108-1

AMP SUPERSEAL 1.5 Series Connectors Rubber Boots

Rubber Boots

No. of Positions	Connector Housing Part Number	Description	Rubber Boot Part Number	Color
2	282080-1	Plug Housing	880810-1	Black
	282104-1	Cap Housing		
3	282087-1	Plug Housing	880811-2	Black
	282105-1	Cap Housing		
5	282089-1	Plug Housing	880814-1	Black
	282107-1	Cap Housing		

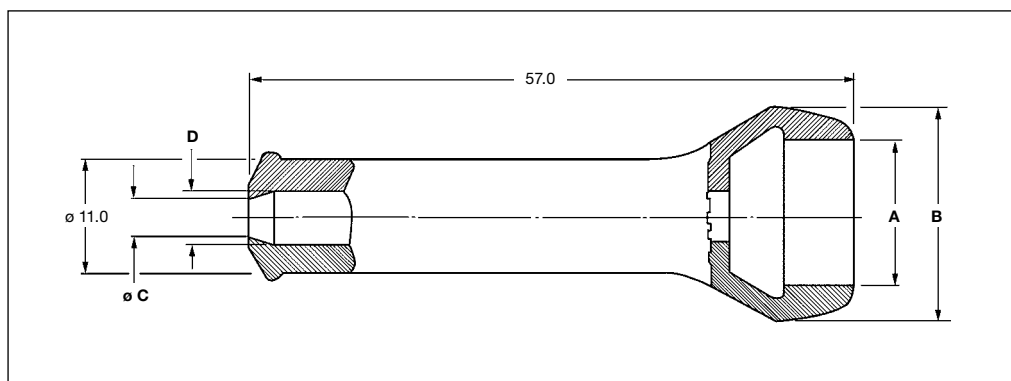

Dimensional Data

No. of Wires	Boot Part Number	Dimensions (mm)			
		A	B	C	D
2	880810-1	12.5	20.5	4.6	5.0
3	880811-2	17.5	25.5	4.6	5.0
4	493581-1*	21.0	34.5	–	7.0
5	880814-1	27.5	35.0	6.5	7.0

*) Different style, see customer drawing

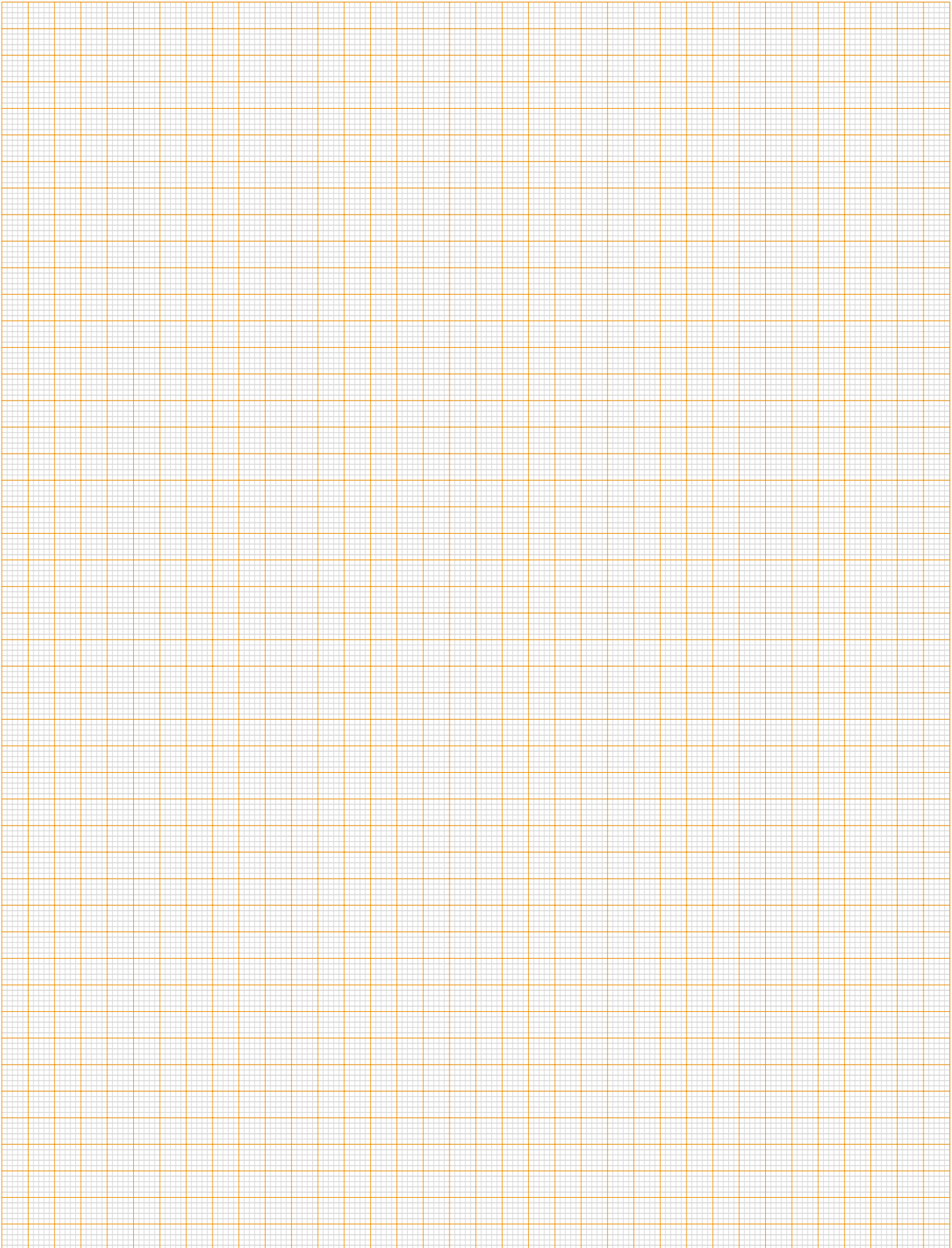

Images representative of tool type only.

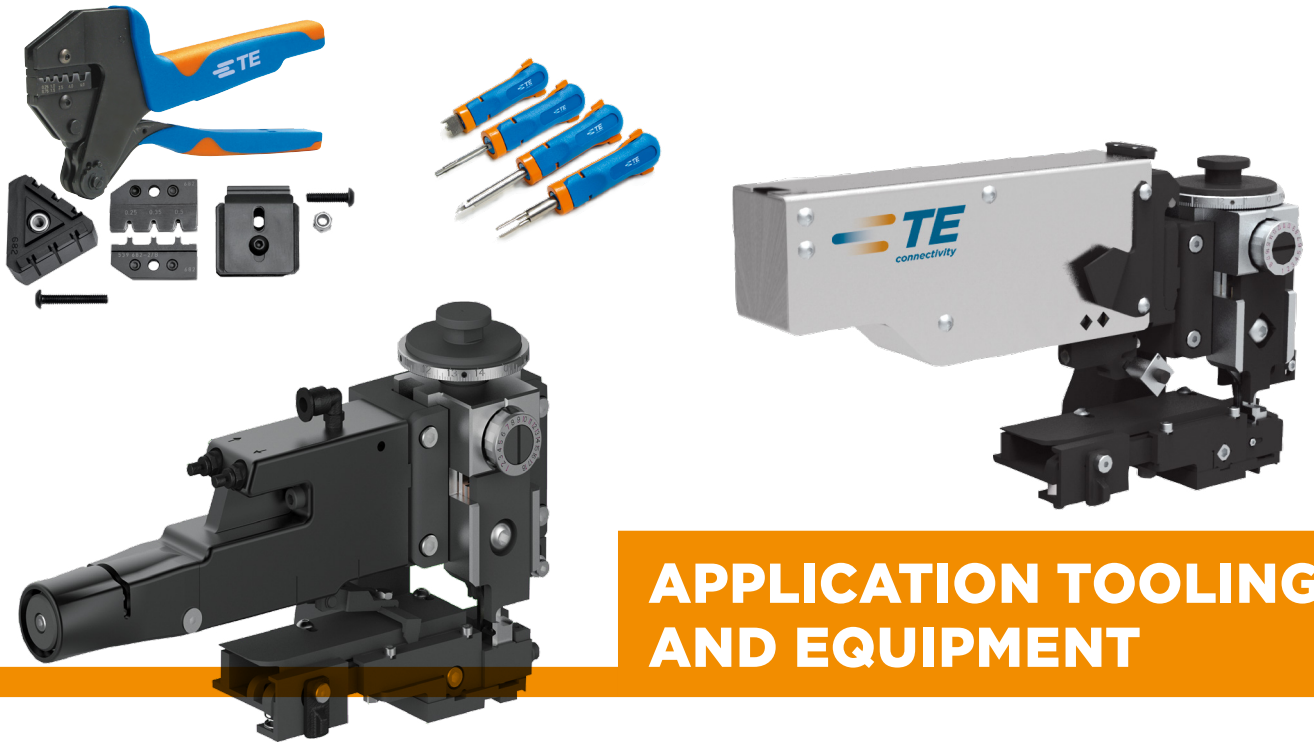

APPLICATION TOOLING AND EQUIPMENT

INTRODUCTION

TE Application Tooling is dedicated to providing high quality equipment options to meet all levels of our connector products specifications. We are also able to provide a broad range of equipment for other manufacturer's products.

Our equipment range is vast and almost unmatched by others operating in the same industry segments, as is our global presence and support network in the form of field service engineers and product managers. We supply everything from simple hand tools to the most complex automated systems.

Equipment is segregated into two types and managed accordingly:

Generic equipment

Where we can supply you with sufficient information referenced by Part Number such that you can identify and order what you need yourself.

Specialised Equipment

Where you will need help from our specialist product managers to identify what's just right for your Application.

Finding Equipment Online

www.tooling.te.com

- Powerful searches to find generic equipment options (Hand Tools / Applicators)
- Brochures and more detailed flyers for the specialised equipment.
- It's quick, easy and more importantly the latest and most up to date information is available online.

Regional Assistance

www.te.com/support-center

Numerical Index

Part Number	Page	Part Number	Page	Part Number	Page
281934-2	4				
281934-3	4				
281934-4	4				
282079-2	5				
282080-1	5				
282081-1	4				
282087-1	5				
282088-1	5				
282089-1	5				
282090-1	5				
282103-1	6				
282104-1	6				
282105-1	6				
282106-1	6				
282107-1	6				
282108-1	6				
282109-1	3				
282109-3	3				
282110-1	2				
282403-1	2				
282404-1	3				
282404-3	3				
282465-1	3				
282466-1	2				

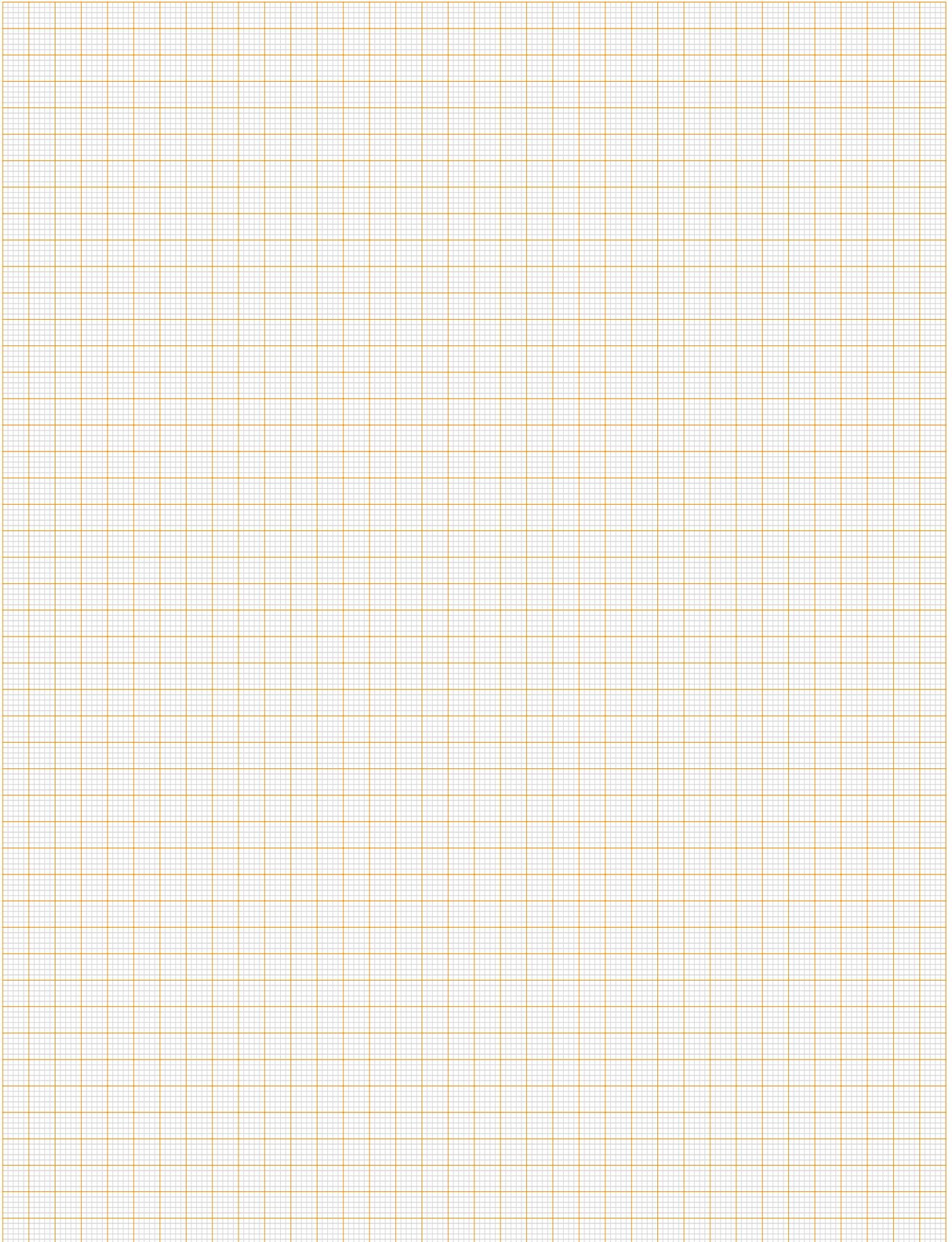

TE CONNECTIVITY ONLINE

TE.com offers an enhanced digital experience, with more than 250,000 parts profiled. The site has deep, rich product data and easier access to tools and services. Other offerings include improved search and navigation and knowledge and idea sharing.



COLLATERAL

TE.com offers a variety of product-specific catalogs, brochures, white papers and other technical information. To download our literature visit

www.te.com/automotiveliterature.html



PRODUCT INFORMATION

Search for a specific product by category, part number or document number.

www.TE.com

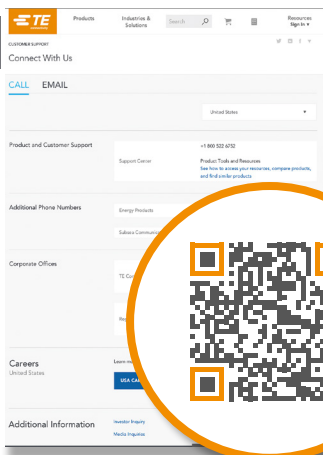

STAY CONNECTED

You can rely on TE's PIC Team to answer your general or technical questions. To contact a PIC representative, visit

www.TE.com/support-center

EUROPE

Germany - Bensheim

Product Information Center:
Phone: +49 6251-133-1999
Fax: +49 6251-133-1988

UNITED STATES

United States - Harrisburg

Product Information Center:
Phone: +1 800-522-6752
Fax: +1 717-986-7575

SOUTH AMERICA

South America

Phone: +54 11-4733-2015
Fax: +54 11-4733-2083

AFRICA

South Africa -
Port Elizabeth

Phone: +27 41-503-4500
Fax: +27 41-581-0440

ASIA/PACIFIC

Australia - Sydney

Product Information Center:
Phone: +61 2-9840-8200
Fax: +61 2-9634-6188

People's Republic of China

Hong Kong
Phone: +852 2738-8731
Fax: +852 2735-0243

People's Republic of China

Shanghai
Phone: +86 21-3398-0000
Fax: +86 21-3398-1999

Korea - Seoul

Phone: +82 2-3415-4500
Fax: +82 2-3486-3810

DISCLAIMER

While TE Connectivity (TE) has made every reasonable effort to ensure the accuracy of the information in this catalog, TE does not guarantee that it is error-free, nor does TE make any other representation, warranty or guarantee that the information is accurate, correct, reliable or current. TE reserves the right to make any adjustments to the information contained herein at any time without notice.

TE expressly disclaims all implied warranties regarding the information contained herein, including, but not limited to, any implied warranties of merchantability or fitness for a particular purpose. The dimensions in this catalog are for reference purposes only and are subject to change without notice. Specifications are subject to change without notice. Consult TE for the latest dimensions and design specifications.

TRADEMARKS

AMP SUPERSEAL 1.5, TE, TE Connectivity, and TE connectivity (logo), are trademarks.

Other product names, logos, and company names mentioned herein may be trademarks of their respective owners.

COPYRIGHT

© 2016 TE Connectivity family of companies.

All rights reserved.

TE Connectivity Germany GmbH certified acc. ISO 14001 and ISO/TS 16949:2002

TE Connectivity Germany GmbH

Ampèrestrasse 12-14 | 64625 Bensheim | Germany

Phone: +49 (0)6251 133-0

Fax: +49 (0)6251 133-1600

