

TDK-Lambda

Glossary of Power Supply Terms

Index

A	1
B	2
C	4
D	8
E	10
F	12
G	14
H	15
I	17
J	19
K	20
L	21
M	23
N	25
O	26
P	28
Q	31
R	32
S	34
T	38
U	40
V	41
W	42
X	43
Y	44
Z	45
Useful Conversion factors	46
Prefixes	46
Lengths	46
Temperature	46
Weights	47
Airflow	47
Energy	48
Cable Size	49
Useful Calculations	51
Resistance and Ohm's Law	51
Reactance	51
Voltage Divider Rule	51
Electrical Energy and Power	51
Capacitors	52
RC Circuits	52
Inductors	52
RL Circuits	53
RLC Circuits (Series Resonant)	53
RLC Circuits (Parallel Resonant)	54
Installation for optimum EMC performance	55
Mounting	55
Cables	55
Connecting between boxes	55
Earth star point	55
External Fusing	56
Safety Approvals	57
TDK-Lambda Company Contacts	58

A

A - Abbreviation for [ampere](#).

ac - Abbreviation for [Alternating Current](#) (written in lower case 'ac').

ac Brownout – See [Brownout](#).

ac-dc converter – A device that changes ac input voltage/current to a different dc output voltage/current. See [Power Supply](#).

ac Line – A conductor that routes ac voltage from one point to another.

ac Line Filter - A circuit placed in the ac line to remove unwanted noise from the ac supply.

ac Loss Detector – A power fail detector circuit that monitors the status of the ac lines.

ANSI – Abbreviation for [American National Standards Institute](#).

ATE – Abbreviation for [Automatic Test Equipment](#).

AWG – Abbreviation for [American Wire Gauge](#).

Accuracy – The correctness of the indicated value.

Accuracy Limits – See [Total Regulation](#).

Adjustment Range – The range over which the parameter (usually applies to output voltage or output current of a power supply) may be adjusted. See also [Setting Range](#).

Air Gap – the separation between magnetic materials used to lower the permeability and increase the ampere turns before the materials saturate.

Alternating Current (ac) – Current which changes the direction in which it flows.

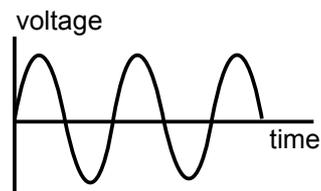

Drawing 1: Alternating Current

Ambient Temperature – The average temperature of the environment immediately surrounding the power supply (PSU). For forced air-cooled units, the ambient temperature is measured at the air intake. See also [Operating Temperature Range](#), [Storage Temperature](#), [Temperature Coefficient](#).

American National Standards Institute (ANSI) – United States standards agency located in New York.

American Wire Gauge (AWG) – A standard for sizing the diameters of wire and for measuring sheet-metal thicknesses. See [Useful Conversion Factors](#).

Ampere (A) – The unit of current. 1 Ampere is equal to a flow of one coulomb of charge per second. SI definition is the current which, if maintained in two straight parallel conductors of infinite length, of negligible circular cross-section, and placed 1 metre apart in a vacuum, would produce a force equal to 2×10^{-7} newtons per metre of length. Written as 'ampere' or 'amp'.

By [Ohm's Law](#), a current of 1 amp through a resistance of 1 [ohm](#) will cause a [potential difference](#) of 1 [volt](#).

Apparent Power – Conventionally expressed in VA (volt-amperes).

Apparent Power = $\text{current}_{\text{rms}} \times \text{voltage}_{\text{rms}}$.

Atto – SI prefix multiplier. Multiplies by 10^{-18} . So 100 aF = 100×10^{-18} F. Written as 'atto'. Abbreviated to 'a'.

Auto-Range Input – The ability for a power supply to automatically operate from a different input voltage ranges. A typical specification for auto range input would be 100Vac to 132Vac and 180Vac to 253Vac. Compare with [Wide Range Input](#).

Auto-Transformer – A single winding transformer with one or more taps.

Automatic Test Equipment (ATE) - is any automated device that is used to test any other related electronic components or modules. It is usually a combination of hardware and software.

Auxiliary Supply – A power source supplying power other than the main load power. This is often an additional output on a power supply for system housekeeping which gives low current and is usually not inhibited with the main output.

Averaging Filter – See [L-C Filter](#).

B

BJT – Abbreviation for [Bipolar Junction Transistor](#).

BOM – Abbreviation for [Bill of Material](#).

BMP – Abbreviation [Board Mount Power](#).

BSI – Abbreviation for [British Standards Institute](#)

BTS – Abbreviation for [Base Transceiver Station](#)

Back Electromotive Force (Back EMF) - An [EMF](#) that occurs in electric motors where there is motion between the armature of the motor and the external magnetic field. See also [Counter Electromotive Force](#).

Backup Power Supply – A power supply (PSU) used to provide alternate system power in the event the primary power source fails or is unable to continue providing adequate system power.

Balun – Converts between **balanced** and **unbalanced** electrical signals/power. A differential wound choke used as an EMI filter component. Presents a high impedance to common-mode signals and a low impedance to differential mode signals.

Base Transceiver Station – A telecommunications term (usually referring to mobile phone installations) describing an installation which contains the transceivers, antennae and equipment for encrypting and decrypting communication with the Base Station Controller.

Baseplate – Mounting platform for power supply (PSU) (either ac/dc or dc/dc) components.

Baseplate Temperature – The temperature at the hottest spot on the mounting platform of the power supply.

Basic Insulation – The insulation applied to live parts to provide basic protection against electric shock. See also [Insulation](#), [Double Insulation](#), [Reinforced Insulation](#), [Supplementary Insulation](#).

Battery Charger – Electrical equipment designed to charge batteries.

Bead – A small ferrite normally used as a high frequency inductor core also a ceramic component used to space resistors from PCB's.

Bench Power Supply – A power source / power supply (PSU) used for bench-top use in a laboratory. Normally has adjustable voltage / current with displays showing settings. TDK-Lambda's Genesys range of supplies is designed for bench top use and has adjustable current and voltage limits.

Bifilar Winding – Two conductors wound side by side.

Bill of Materials – Describes the raw materials, sub-assemblies, intermediate assemblies, sub-components, components, parts and the quantities of each needed to manufacture a final product.

Bipolar Junction Transistor (BJT) – A type of [Transistor](#) with 3 terminals. Used as either a switch or amplifier.

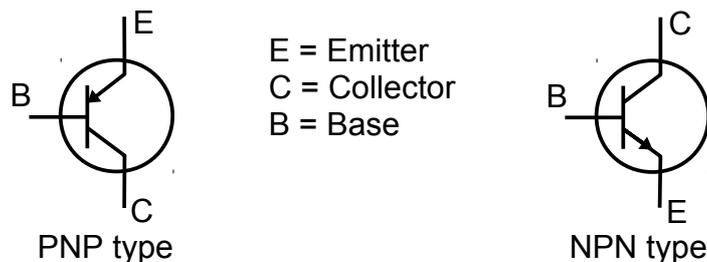

Drawing 2: Schematic Symbols for BJT's

Bleed – A low current drain from a power source.

Bleed Resistor – A resistor that allows a current drain on a power source. Usually to discharge filter capacitors or to stabilise an output. See [Minimum Load](#).

Board Mount Power – Refers to encapsulated and open PCB power converters that are mounted on larged PCBs.

Bobbin – An [insulator](#) used to support windings.

Bonding – Permanently joining all non-current-carrying metal parts to ensure electrical continuity and the ability to conduct safely any current likely to be imposed on it. Often called Earth Bonding.

Boost Converter – A switching power supply topology. It accepts variable dc input voltage and converts it to a higher dc voltage.

Boost Regulator – See [Boost Converter](#).

Breakdown Voltage – 1) The voltage level at which insulation fails.

2) The reverse voltage at which a semiconductor device changes its conductive characteristics.

Brick – See [Full Brick](#).

Bridge Rectifier – Full-wave rectifier circuit employing two or more rectifiers in a bridge configuration.

Compare with [Half-Wave Rectifier](#).

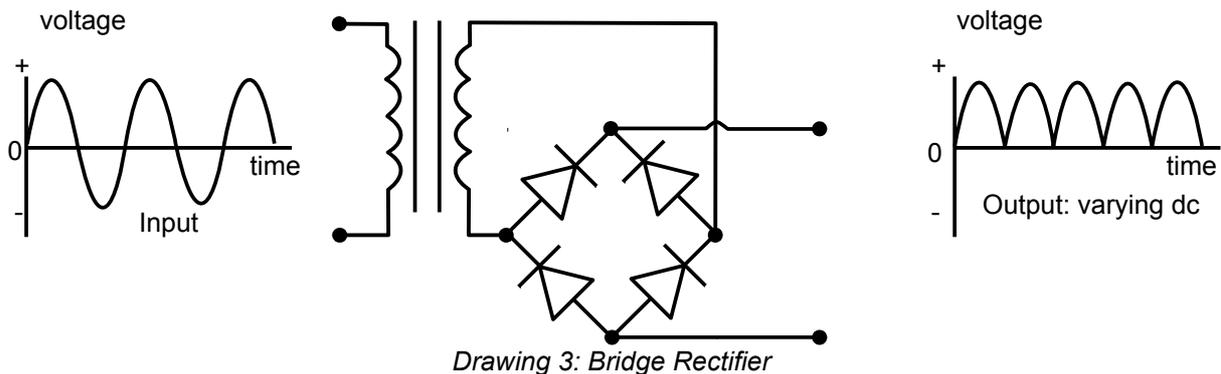

British Standards Institute – The National Standards Body of the UK, founded in 1901, develops standards and standardization solutions to meet the needs of business and society. (<http://www.bsi-global.com/>).

Brownout – The condition created when the electricity supply (usually ac) falls below the minimum level specified for the system. Some brownouts are made intentionally to prevent a full power outage during periods of electricity demand overload.

Buck Regulator – A power supply topology which accepts an unregulated dc input voltage and produces a regulated lower output dc voltage.

Bulk Capacitor – The energy storage capacitor at the front end of a regulator.

Bulk Voltage – The voltage across a bulk capacitor.

Burn In – The operation of a newly fabricated device or system prior to application with the intent to stabilise the device, detect defects, and expose infant mortality. See also [Power Cycle](#).

Bus – Conductor which distributes power (or signals) from a power source (or signal source) to two or more separate circuits.

Bus Converter – A type of [dc-dc converter](#) usually used in [Distributed Power Architecture](#) which provides an isolated intermediate bus voltage to power non-isolated [Point of Load Converters](#). Usually 48Vdc input, 12Vdc output. TDK-Lambda's range of bus converters includes the iEB and iQD ranges.

C

C – Abbreviation for [capacitance](#), [capacitor](#) and coulomb.

°C – Abbreviation for degrees Celsius, or degrees Centigrade.

CB Report – Abbreviation of Certification Body's (or Bodies') Test Report.

CB Scheme – Abbreviation of Certification Bodies' Scheme. An international scheme to facilitate international trade in electrical equipment, primarily intended for use in homes, offices, workshops, healthcare facilities and similar locations, for benefit of consumers, industries, authorities etc., and to provide convenience for manufacturers and other users of the services provided by various National Certification Bodies (NCBs). It is operated by the [IECEE](#). See <http://www.iecee.org/> for more details.

CB Test Certificate - Abbreviation of Certification Body's (or Bodies') Test Certificate. It is a formal [CB Scheme](#) document issued by an authorized NCB (National Certification Body) to inform other NCBs that a sample of the product tested was found to be in compliance with the applicable requirements. CB Test Certificates should not be used for advertising purpose, however reference to the existence of a CB Test Certificate is permitted. A manufacturer utilizing a CB test certificate issued by one of the accepted National Certification Bodies (NCBs) can obtain certification marks of the latter, within their scope of adherence, in the countries where the accepted NCBs are located. See <http://www.iecee.org/> for more details. Also see [International Electrotechnical Commission](#).

CB Test Report - Abbreviation of Certification Body's (or Bodies') Test Report. A test report issued by an Issuing and Recognizing NCB (National Certification Body). is a standardized report in a clause by clause checklist format referencing, the requirements of the relevant IEC Standard. The Test Report provides clear and unambiguous results of all the required tests, measurements, verifications, inspections and evaluations. It also contains photographs, electrical diagrams, artwork drawings as well as a description of the product. Under the rules of the [CB Scheme](#), a CB Test Report is considered valid only if accompanied by its [CB Test Certificate](#). See <http://www.iecee.org/> for more details.

CCA – Centralised Control Architecture.

CGS – Abbreviation of [centimetre-gram-second system](#).

CEN – Abbreviation for Comité Européen de Normalisation. See [European Committee for Standardisation](#).

CENELEC – Abbreviation for Comité European Committee for Electrotechnical Standardization. Européen de Normalisation Electrotechnique. See [European Committee for Electrotechnical Standardization](#). <http://www.cenelec.eu/>

CMOS – Abbreviation for Complementary [Metal-Oxide Semiconductor](#). Complementary because the design uses 2 transistors for logic functions, only one being switched on at a time.

COTS – Acronym for [Commercial off the shelf](#).

CSA – Abbreviation for [Canadian Standards Association](#).

Canadian Standards Association (CSA) – An organisation chartered to test and evaluate products and to set applicable safety standards in Canada. <http://www.csa.ca/>

Capacitance – Inherent property of an electric circuit or device that opposes change in voltage. The size of a capacitor (in farads).

Capacitive Coupling – Coupling resulting from the capacitive effect between circuit elements.

Capacitive Reactance (X_c) – Opposition to ac due to capacitance.

Capacitor – A charge storage device. A simple capacitor consists of two conductors separated by a dielectric.

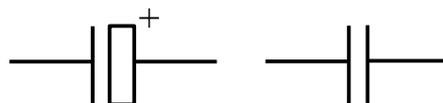

Drawing 4: Schematic Symbol for an Electrolytic Capacitor (polarised) and a non polarised Capacitor

Catch Diode – See [Free Wheel Diode](#).

Celsius – The SI derived unit of temperature. See [Temperature](#). Written as 'degrees Celsius'. Abbreviate to °C.

Centi – SI prefix multiplier. Multiplies by 10^{-2} . So $100 \text{ cF} = 100 \times 10^{-2} \text{ F} = 1\text{F}$. Written as 'centi'. Abbreviated to 'c'.

Centigrade – The previous name for Celsius (changed in 1948). Written as 'degrees Centigrade' or '°C'.

Centimetre-Gram-Second System (CGS) – Obsolete system of physical units. Replaced by [SI](#) units.

- Centralised Control Architecture (CCA)** – A power control/distribution architecture which involves a centralised power management controller driving single or multiple switching termination modules known as ‘power blocks’.
- Centre Tap** – An electrical connection made at the centre of a transformer or inductor winding, with an equal number of turns on either side of the tap.
- Charge** – The potential energy stored in a capacitive electrical device. Unit is coulomb.
- Chassis** – The structure supporting or enclosing the power supply (PSU).
- Chassis Ground** – If the product is earthed, the protective earthing point or potential for the chassis of the product. If the product is not earthed then chassis ground is the voltage potential of the chassis.
- Choke, Choke Coil** – An [Inductor](#).
- Choke, RF** – A choke with a high impedance at radio frequencies.
- Circulating Current** – See [Ground Loop](#).
- Clamp Circuit** – A circuit that limits a voltage waveform so that it cannot exceed a specific level.
- Clamp Diode** – A [diode](#) in a clamp circuit.
- Class A (EMC)** – See [Curve A](#).
- Class B (EMC)** – See [Curve B](#).
- Clearance Distance** – The shortest path, through air, separating two conductors or two circuit components.
- Clock** – An oscillator producing timing pulses to synchronise various elements of a system.
- Coercivity** – A measure of the reverse field needed to drive the magnetisation to zero after being saturated. See also [Hysteresis Loop](#), [Remanence](#).
- Commercial off the Shelf (COTS)** - a term used for standard (not custom) systems. This is most often used in military but also computer and occasionally robotic systems.
- Common-Mode Noise** – Noise that appears equally and in phase on conductors relative to a common reference.
- Common-Mode Output** – The electrical output supplied to a load connected between the terminals of the ungrounded floating output of a power supply (PSU) and the ground point to which the source power is returned.
- Common Point** – The output/sense terminal which is designated 'common' to which load, reference and external programming signal all return.
- Common Return** – A return conductor to two or more circuits.
- Communications Port** – (Comms port) A standard communications interface, such as [IEEE488 \(GPIB\)](#), [RS-232](#), [RS-485](#), [I²C](#), [Ethernet](#) or [USB](#), that provides information flow from a processor to a peripheral device, such as a power supply (PSU).
- Compliance Voltage** – The output dc voltage of a constant current supply.
- Compliance Range** – Range of voltage needed to sustain a given constant current throughout a range of load resistance.
- Component** – An element in an electric circuit.
- Conductance (G)** – The ability to conduct current. It is equal to amperes per volt, or the reciprocal of resistance, and is measured in siemens (metric) or mhos (English) (1 siemens = 1 mho).
- $$G = \frac{1}{R} = \frac{I}{V}$$
- Conductor** – Material which allows an electric current to pass through it (usually metal).
- Configurator** – An automatic product selection tool. It will ensure that the product selected best matches the requirements placed upon it. An example configurator can be seen at <http://config.nv-power.com/>.
- Conformal Coating** – An insulating layer often applied by spraying or dipping that covers and protects the components on a circuit board. Used to provide protection against dust or other contaminants.
- Conformance** – Manufacturer’s commitment that product meets specified standards.
- Connector** – A mechanical device used to link conductors.
- Conversion Factors** – See [Useful Conversion Factors](#).
- Constant Current Limiting** – Current-limiting circuit that holds output current at a maximum value whenever an overload is experienced. For most power supplies, the performance is not truly constant current but reflects the curve shown in the [Current Limiting](#) definition.
- Constant Current Load** – An electronic load with a control loop to regulate the current drawn from the power supply (PSU).
- Constant Current Power Supply** – A power supply (PSU) that regulates its output current, within specified limits, against changes in load and other factors.
- Constant Voltage Power Supply** – A power supply (PSU) that regulates its output voltage within specified limits, against changes in load and other factors.

Constant Voltage Transformer – A power conditioning device which maintains approximately constant voltage ratio over the range from zero to rated output. It is a low maintenance device with few components but is generally large.

Continuous Duty – operation at almost constant load for an indefinitely long time. See also [Intermittent Duty](#).

Control Resolution – The smallest controlled increment of the stabilised output signal (usually applies to output voltage or current).

Convection – The transfer of heat in a gas or liquid (usually refers to air in power supplies).

Convection Cooled Power Supply – A power supply (PSU) cooled only by the convection (usually air) over the surfaces of heat dissipating elements.

Converter – A device / power supply that changes power from one form or level to another.. Examples: [DC-DC](#); a device that delivers dc power when energised from a dc source. [Fly-back converter](#), [Forward Converter](#) - types of switching power supply circuits.

Cooling – The process of removing heat dissipated by a power supply (PSU).

Copper Loss – Heat loss in components or conductors as the result of wire resistance. Calculated using the equation:- $Copper\ Loss = I^2 R$ (where I = current flowing and R = resistance of wire).

Cord Set – A flexible cord terminated at one end with an attachment plug and a second connector at the other (usually for ac input to the power supply).

Core – Material (usually ferrous eg [Ferrite](#) or iron) serving as a path for magnetic flux usually in an inductor.

Core Loss – Power dissipated by a magnetic core due to hysteresis and eddy currents.

Core Saturation – The tendency of molecules in a core to orient in one direction due to excess magnetic flux densities. In most applications, core saturation is an undesirable effect which is avoided through good design: engineering the windings and core so that magnetic flux densities remain well below the saturation levels. Saturation has several causes: operating the core at a different/lower frequency, presence of DC current in the winding, overloading the winding with excess applied voltage.

Coulomb – (abbreviation C) the [SI](#) unit of electric charge. It is the amount of charge carried by a current of 1 ampere flowing for 1 second.

Counter Electromotive Force (Counter EMF or CEMF) – The voltage developed in an [inductor](#) by an alternating or pulsating current. The polarity of this voltage is at every instant opposite that of the applied voltage. Sometimes called [Back EMF](#).

Creepage Distance – The shortest distance separating two conductors as measured along a surface touching both conductors.

Crest Value – Maximum value of a waveform excluding transients (also called [Peak Value](#)).

Cross Regulation - The change of one output voltage as the load is changed on another output with all other factors constant. Usually expressed as a percentage of the nominal output. See also [Regulation](#).

Crowbar – An overvoltage protection circuit which will rapidly place a low resistance shunt across the power supply (PSU) output terminals if a predetermined voltage is exceeded. Not usually used in switched mode power supplies as they have more sophisticated overvoltage protection methods.

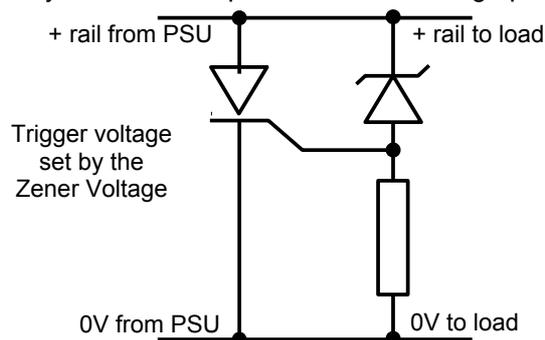

Drawing 5: Overvoltage Crowbar Circuit

Current (I) - The rate of transfer of electrical charge measured in [amperes](#) (amps).

Current Foldback – See [Foldback Current Limiting](#).

Current Limit Knee - The point on the plot of current v voltage of a supply at which the current starts to foldback, or limit.

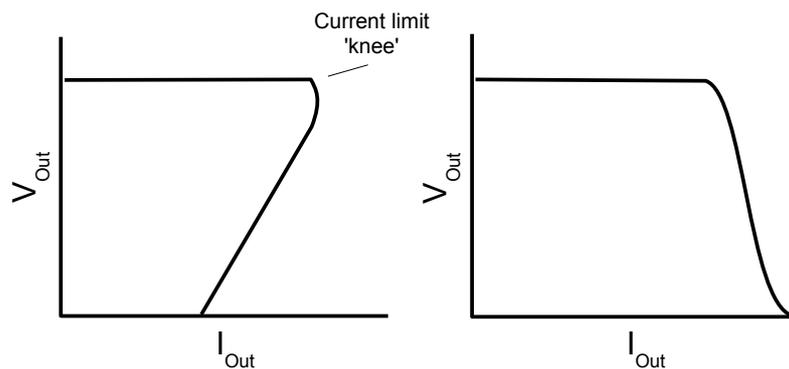

Drawing 6: Foldback Current Limiting and 'Constant' Current Limiting

Current Limiting – An electronic overload protection circuit which limits the maximum output current to a preset value. Please note that power supplies incorporate current limiting usually to protect the power supplies. Care must be taken to ensure that connecting leads and any PCB tracks are designed to allow for the maximum current possible from the power supply (or supply additional protection circuitry / fusing for protection).

Current Sensing Resistor – A resistor placed in series with the load to develop a voltage proportional to load current.

Current Source – A power source that delivers constant current at a specified level.

Curve A (or Class A) – See [Curve B](#).

Curve B (or Class B) – Relates to conducted or radiated [EMC](#) performance, usually EN55022 which specifies two levels.

Level/Class/Curve A which is for equipment designed to operate in EMI tolerant environments such as industrial locations.

Level/Class/Curve B which is for equipment installed in EMI sensitive areas (such as domestic, commercial and light industrial).

Products which achieve curve B will always achieve curve A also as it allows higher levels of conducted or radiated noise than curve B.

D

dB – Abbreviation for [Decibel](#).

dc – Abbreviation for Direct Current.

DIN – Acronym for Deutsches Institut für Normung e.V. (German Institute for Standardisation).

DOSA – Acronym for [Distributed-power Open Systems Alliance](#).

DPA – Abbreviation for [Distributed Power Architecture](#).

DVT – Abbreviation for [Design Validation Testing](#).

dc Component – The dc part of an ac wave.

dc-dc converter – A circuit or device that changes dc input voltage/current to a different dc output voltage/current. Normally the output of a dc/dc converter is isolated from the input. Non isolated versions are available (usually called [Point of Load Converters](#)). TDK-Lambda's PSS, PSD, PXD, PXE, PXF and PL series are excellent examples of dc-dc converters.

Decay Time – See [Fall Time](#).

Deca – SI prefix multiplier. Multiplies by 10^1 . So 100 daF = 100×10^1 F = 1000F. Written as 'deca'. Abbreviated to 'da'.

Deci – SI prefix multiplier. Multiplies by 10^{-1} . So 100 dF = 100×10^{-1} F = 10F. Written as 'deci'. Abbreviated to 'd'.

Decibel – The numerical expression of the relative loudness of two signals, such as sound. The difference in decibels between two signals is ten times the common logarithm of the ratio of their powers. Abbreviated to dB.

Decoupling – Power supply decoupling is used to compensate for the impedance of the output of the power supply and the interconnecting leads. This impedance may prevent the power supply reacting quickly to the rapidly changing loads that are common in modern electronic equipment. Decoupling of the output should be carried out with electrolytic capacitors for medium frequencies and ceramic capacitors for high frequencies. The capacitors should be connected as closely as possible to the load for the best results.

Density – The ratio of mass of material to its own volume. See also [Power Density](#).

Derating – 1) operating components or devices at lower stress levels than maximum specified capabilities in order to reduce the occurrence of stress-related failures.

2) Reduced output power available from a power supply under certain conditions (especially elevated temperature).

Design Life – Expected length of time of acceptable performance under specified conditions.

Design Validation Testing (DVT) – Testing performed at various stages throughout a product's development cycle to ensure that the initial design specifications are achieved. The DVT will usually involve performing many varied tests, including i) functional testing, ii) reliability testing, iii) ESD testing, iv) EMC testing, v) environmental testing.

Design Verification Test (DVT) – See [Design Validation Testing](#).

Differential Mode Noise – The component of noise that is measured between two lines with respect to a common reference point. The value is the difference of the noise components on the two lines. This excludes common-mode noise.

Differential Voltage – The difference in voltages at two points.

DIN Rail -Standardised metal rail (35mm wide shown here). Used to mount building automation electronics, industrial control electronics, power supplies, circuit breakers, etc. usually inside equipment racks.

Other sizes exist including

15mm (EN 50045, BS 6273) where dimension a = 15mm, b = 8.5mm, c = 5.5mm, d = 1mm

G type asymmetric DIN rail (EN 50035, BS 5825) (different profile to below)

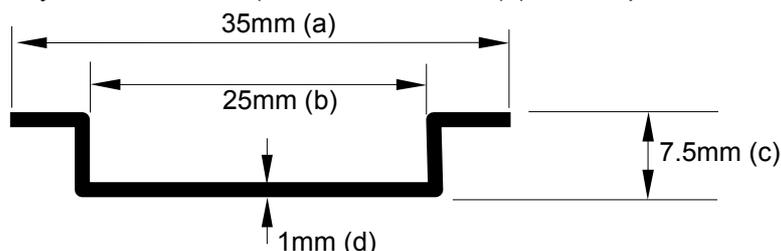

Drawing 7: DIN Rail - EN 50022, BS 5584

DIN Rail Power Supply – A [Power Supply](#) that mounts directly onto a [DIN Rail](#). TDK-Lambda's DLP, DPP and DSP ranges are excellent examples of Din Rail Power Supplies displaying many of the attributes useful for this type of power supply: compact size, high efficiency, convection cooled, etc.).

Diode – A component containing a cathode and an anode that allows current flow in one direction (anode to cathode) and blocks flow from the other (cathode to anode).

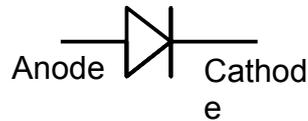

Drawing 8: Schematic Symbol for a Diode

Direct Current (dc) – Flow of current in one direction. Written: dc.

Distributed Power Architecture (DPA) – A system power architecture where the ac supply into the system is converted by a [Front End Power Supply](#) into a safe voltage (usually 12V, although 48V is common) which is then converted by [dc-dc converters](#) or [point of load converters](#) locally to the load requiring the (usually) lower voltage. Benefits of Distributed Power Architecture (DPA) are spreading the power losses throughout the system (which reduces the need for additional cooling, such as heatsinking or blown air), distribution of a higher voltage bus (such as 12V) will be more efficient than distributing 3.3V (or lower) from a centralised power supply. See also [Bus Converter](#). TDK-Lambda has a range of products suitable for designing into a Distributed Power Architecture (DPA). These include the NV-350 FEP (350W front end power supply), FPS (1000W – 3000W front end power supply) and a full range of dc/dc converters such as the PA range [up to 700W], [bus converters](#) and non isolated [point of load converters](#) (such as the PL range [available with up to 20A outputs]).

Distributed-power Open Systems Alliance (DOSA) - formed to ensure future DC/DC product compatibility and standardization within the increasingly fragmented power converter market. The goal of the alliance is to establish customer interface standards early in the development cycle, which include form factors, footprints, pin-outs, feature sets and other parameters that will permit alternative sourcing. The alliance will cover a broad range of power converters including non-isolated (POL), isolated applications, and intermediate bus converters.

Double Insulation – An insulation system comprised of [basic insulation](#) and [supplementary insulation](#). Generally, if equipment is double insulated, it does not need to be earthed. See also [Reinforced Insulation](#).



Drawing 9: Symbol for double insulated devices

Drift – A change in output over a period of time independent of input, environment or load or other factors.

Duty Cycle – In a recurring event, the ratio of on time to off time.

Dynamic Load – A load that changes from one level to another. To be fully specified, both the size and rate of change must be stated.

E

EIA – Abbreviation for [Electronic Industries Association](#).

EMC – Abbreviation for [Electromagnetic Compatibility](#).

EMI – Abbreviation for [Electromagnetic Interference](#).

EMI Filter – A circuit for the attenuation of the electromagnetic interference emitted from (or received by) a power supply (PSU) or other equipment. See also [EMI](#).

EMV – Abbreviation for Elektromagnetische Verträglichkeit (German: [Electromagnetic Compatibility](#)).

EN – Abbreviation for Norme Européen ([European Standard](#)).

ESD – Abbreviation for [Electrostatic Discharge](#).

ESL – Abbreviation for [Equivalent Series Inductance](#).

ESR – Abbreviation for [Equivalent Series Resistance](#).

Earth – An electrical connection to the earth frequently using a grid or rod(s). See also [Ground](#).

Earth Bond – See [Bonding](#).

Earth Leakage Current – The ac or dc current to chassis/earth of a power supply (PSU) at a specified input voltage/frequency. Medical power supplies have specific requirements for Earth Leakage currents and this varies depending on standard to be met.

Effective Value – The value of a waveform that has the equivalent effect of a direct current.

The Effective Value = RMS (Root Mean Square) Value

(For sine waves this equates to $\sqrt{2}$ x Peak value).

Efficiency – The ratio of total output power to total input power, expressed as a percentage, under specified conditions. Maximum theoretically possible efficiency is 100%. A power supply which is 90% efficient wastes one third as much power as a power supply which is 75% efficient. As efficiencies approach 100%, improvements become harder to achieve.

Eighth Brick - Industry standard footprint for dc-dc converters. Dimensions are 57.9mm x 22.8mm (2.3in x 0.9in). See also [Full Brick](#), [Half Brick](#), [Quarter Brick](#), [Sixteenth Brick](#). TDK-Lambda's PAE range of dc/dc converters are examples of eighth bricks.

Electricity – Property of matter that results from the presence or movement of electric charge.

Electrolytic Capacitor – A capacitor that contains two electrodes separated by an electrolyte.

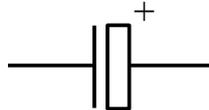

Drawing 10: Schematic Symbol for an Electrolytic Capacitor

Electromagnet – A type of magnet in which the magnetic field is produced by a flow of electric current. The field disappears when the current stops.

Electromagnetic Compatibility (EMC) - The capability of equipment or systems to be used in their intended environment within designed efficiency levels without causing or receiving degradation due to unintentional EMI. EMC generally encompasses all of the electromagnetic disciplines.

Electromagnetic Interference (EMI) – Any electronic disturbance that does or could interrupt, obstruct, or otherwise impair the performance of electronic equipment. EMI is characterised by the following categories for test and measurement purposes: 1. Conducted Emissions, 2. Radiated Emissions, 3. Conducted Susceptibility, 4. Radiated Susceptibility.

Electromotive Force (EMF) – Force that causes free electrons to move in a conductor. Unit of measurement is the volt.

Electron (e⁻) – Negatively charged particle.

Electron Volt (eV) – A unit of energy. The energy acquired by an electron passing through a potential of one volt. See [Useful Conversion Factors](#)

Electronic Industries Association (EIA) – US based trade group <http://www.eia.org/>.

Electronic Load – Test equipment which draws controlled amounts of power or current from a power supply. Part of the [ATE](#) used to fully test a power supply during its functional testing stage.

Electrostatic Discharge (ESD) – The flow of current that results when objects having a static charge come into a close enough proximity to discharge. Usually used to describe momentary unwanted currents that cause damage to electronic equipment / components.

Electrostatic Field – Electric field around a charged body.

Electrostatic Shield – A conductive screen that shunts induced energy to ground. See [Faraday Shield](#).

Enable – A signal input to a power supply which will turn on the outputs (if the unit is fan cooled then this may also enable the fan). The signal has to be activated to make the outputs turn on. With nothing connected to the input, the power supply should not operate. (Compare this with [Inhibit](#)).

Encoder – See [Rotary Encoder](#).

Energy – The capacity of a system to do work. The unit is [joule](#).

Equivalent Series Inductance (ESL) – The amount of inductance in series with an ideal capacitor which exactly duplicates the performance of a real capacitor.

Equivalent Series Resistance (ESR) – The amount of resistance in series with an ideal capacitor which exactly duplicates the performance of a real capacitor.

Ethernet – A serial communication bus mostly used to connect equipment in a LAN (local area network). Some power supplies can be supplied with Ethernet communications to allow remote control via the computer network. See [Communications Port](#).

European Committee for Electrotechnical Standardization - CENELEC is a non-profit technical organization set up under Belgian law and composed of the National Electrotechnical Committees of 30 European countries. In addition, 8 National Committees from neighbouring countries are participating in CENELEC work with an Affiliate status.

CENELEC members have been working together in the interests of European harmonization since the 1950s, creating both standards requested by the market and harmonized standards in support of European legislation and which have helped to shape the European Internal Market. CENELEC works with 15,000 technical experts from 30 European countries. Its work directly increases market potential, encourages technological development and guarantees the safety and health of consumers and workers.

CENELEC's mission is to prepare voluntary electrotechnical standards that help develop the Single European Market/European Economic Area for electrical and electronic goods and services removing barriers to trade, creating new markets and cutting compliance costs.

A Resolution of 7th May 1985 of the European Council formally endorsed the principle of reference to European standards within the relevant European regulatory work (Directives), thereby paving the way to a New Approach in the philosophy of regulations and standards in Europe. In the light of this New Approach, CENELEC is developing and achieving a coherent set of voluntary electrotechnical standards as a basis for the creation of the Single European Market/European Economic Area without internal frontiers for goods and services.

In addition to the traditional European standard deliverables, the dynamic Workshop (CWA: CENELEC Workshop Agreement) has been included in its portfolio, offering an open platform to foster the development of pre-standards for short lifetime products where time-to-market is critical.

<http://www.cenelec.eu/>

European Committee for Standardisation (CEN) – (Comité Européen de Normalisation). Contributes to the objectives of the European Union and European Economic Area with voluntary technical standards which promote free trade, the safety of workers and consumers, interoperability of networks, environmental protection, exploitation of research and development programmes, and public procurement. <http://www.cenorm.be/>

European Standard - standard adopted by CEN/CENELEC and carrying with it an obligation of implementation as an identical national standard and withdrawal of conflicting national standards.

Exa – SI prefix multiplier. Multiplies by 10^{18} . So 100 EF = 100×10^{18} F. Written as 'exa'. Abbreviated to 'E'.

F

F – Abbreviation of [farad](#).

°F – Abbreviation for degrees Fahrenheit.

FET – Abbreviation for [Field Effect Transistor](#).

FCC – Abbreviation for [Federal Communications Commission](#).

FR-2 – A low cost [Printed Circuit Board](#) material. Construction is from paper impregnated with phenolic resin.

FR-4 – A [Printed Circuit Board](#) material. Construction is from woven fibreglass mat impregnated with a flame resistant epoxy resin. It is much stronger than [FR-2](#) but more expensive.

Failure Mode – The way in which a device does not meet specified requirements.

Fall Time – The time required for a [Pulse](#) to decrease from 90% to 10% of its maximum positive (or negative) amplitude.

Fan Cooled – A method of forced-air cooling used to maintain design temperatures.

Farad – Unit of measurement of [Capacitance](#). Written as 'farad'. Abbreviation is 'F'

Faraday Cage – A conducting screen completely surrounding a space to exclude electromagnetic fields. Often put to a dual purpose: to block electric fields and to block electromagnetic radiation (RF shielding).

Faraday Shield – An electrostatic shield between input and output windings of a transformer. This can be used to reduce coupling capacitance which in turn reduces output common mode noise. See also [Electrostatic Shield](#).

Fault Tolerant – System redundancy to provide continued operation following specified failures.

Federal Communications Commission (FCC) – An independent US government agency. Regulates the use of the radio spectrum and telecommunications within (or originating in) the USA.
<http://www.fcc.gov/>

Femto – SI prefix multiplier. Multiplies by 10^{-15} . So 100 fF = 100×10^{-15} F. Written as 'femto'. Abbreviated to 'f'.

Ferrite – A ceramic, soft magnetic material with low loss at high frequencies and which contains iron oxide mixed with oxides or carbonates of one or more metals such as manganese, zinc, nickel or magnesium. Invented by TDK's founder, Dr. Yogoro Kato and Dr. Takeshi Takeiin. TDK Corporation was founded to commercialize this material in 1935.

Field Effect Transistor (FET) - A transistor that relies on an electric field to control the conductivity of a 'channel' in a semiconductor material. They are sometimes used as voltage-controlled resistors. All FETs, [except [J-FETs](#) (Junction Field Effect Transistors)] have four terminals (gate, drain, source and body/base). J-FETs have no body. Enhancement FETs are normally off (a voltage applied between the source and gate increases the current from source to drain), depletion FETs are normally on (a voltage applied between the source and gate decreases the current from source to drain).

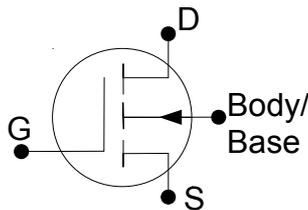

Drawing 11: Schematic Symbol for a FET

Filter - A generic term for any circuit which performs some type of signal processing. Normally this is to remove/attenuate unwanted signals (noise). Noise filters for power supply (PSU) outputs (and inputs) are generally passive.

Floating Output - An output of a power supply (PSU) that is not connected to any other output or earth, usually denotes full galvanic isolation. Usually, they can be used as either positive or negative outputs.

Flyback Converter – A simple switched mode power supply topology. In most cases, it uses one switch and only needs one magnetic element - the transformer. Energy is transferred during the off-time of the primary circuit. They are generally limited to outputs of less than 200 watts.

Foldback Current Limiting Circuit - Current limiting circuit that gradually decreases the output current under overload conditions until some minimum current level is reached under a direct short circuit. See [Current Limit](#).

Forward Converter – An isolated form of the [Buck Regulator](#) which is capable of producing output voltages higher or lower than the input voltage.

Free Wheel Diode - A diode used to provide a path for current to flow from an inductive device. See also [Catch Diode](#).

Frequency – The measurement of the number of times that a repeated event occurs per unit of time. The unit of measurement is hertz (Hz) which is repetitions per second (cycles per second – cps).

$$f = \frac{1}{T} \quad \text{Where } f = \text{frequency (Hz) and } T \text{ is the period in seconds.}$$

$$\text{Alternatively, } f = \frac{n}{t} \quad \text{where } t = \text{time (seconds) and } n = \text{number of cycles}$$

Front End Power Supply – A [power supply](#) intended for use in [Distributed Power Architecture](#) systems to provide the ac/dc conversion. It will usually provide 12V output to supply [Point of Load Converters](#) directly. TDK-Lambda's range of front end power supplies includes the FPS1000 (1kW up to 3kW) and NV-350FEP (up to 350W).

Full Brick - Industry standard footprint for dc-dc converters. Dimensions are 116.8mm x 61mm (4.6in x 2.4in). See also [Half Brick](#), [Quarter Brick](#), [Eighth Brick](#), [Sixteenth Brick](#). TDK-Lambda's PAF range of dc/dc converters are examples of full bricks.

Full-Wave Rectifier – A circuit element, such as a [bridge-rectifier](#), that rectifies both halves of the input ac wave to produce a varying dc output. Compare with [Half-Wave Rectifier](#).

Fuse – Abbreviation of 'fusible link'. An overcurrent protection device. See [External Fusing](#).



Drawing 12: Schematic Symbols for a Fuse

Fusible Link – See [Fuse](#)

G

GPIB – Abbreviation of [General Purpose Interface Bus](#).

Galvanic - related to direct-current electricity or dc.

Galvanic Isolation – separation of the signal/power source (or sink) in such a way that dc current cannot bridge the connection. There are two generally accepted methods for galvanic isolation: use of transformers or use of optical isolators. Both allow the ac component of a signal to pass, but not the dc component.

General Purpose Interface Bus – A parallel communications bus. Used to connect electronic test and measurement devices to control equipment (such as a computer). Also known as [IEEE488](#). See [Communications Port](#).

Giga – SI prefix multiplier. Multiplies by 10^9 . So 100 GHz = 100×10^9 Hz. Written as 'giga'. Abbreviated to 'G'.

Glitch – An unwanted transient voltage spike occurring on a signal.

Ground – A conducting connection, whether intentional or accidental, by which an electric circuit or equipment is connected to earth, or to some conducting body that serves in place of earth.



Drawing 13: Schematic Symbol for Ground (or Earth)

Ground Bus – A bus, grounded in at least one place, to which individual grounds in a system are attached.

Ground Grid – Interconnected bare conductor arranged in a pattern over a specified area, laid out on or below the earth's surface.

Ground Loop – A condition that occurs when there is more than one ground connection path between two pieces of equipment or circuits. These multiple paths produce a similar effect to a loop antenna which will pick up and radiate interference.

Ground Plane – 1) A layer of copper on a PCB providing a low impedance ground return to all circuit elements needing it. Also for shielding.

2) A conductive surface serving as the circuit reference ground or as a near-field reflection point for an antenna

Ground Rod – A metal rod, usually copper clad, driven into the earth to serve as a ground terminal.

Grounded – Connected to a common reference point (usually earth).

H

H – Abbreviation for [henry](#), Magnetic Field Strength, or Magnetomotive Force.

HALT – Acronym for [Highly Accelerated Life Testing](#).

HASS – Acronym for [Highly Accelerated Stress Screening](#).

HBC – Abbreviation of [High Breaking Capacity](#).

Hz – Abbreviation for [hertz](#).

Half Brick - Industry standard footprint for dc-dc converters. Dimensions are 61mm x 57.9mm (2.4in x 2.28in). See also [Full Brick](#), [Quarter Brick](#), [Eighth Brick](#), [Sixteenth Brick](#).. TDK-Lambda's PAH range of dc/dc converters are examples of half bricks.

Half-Wave Rectifier – A component, such as a diode, that rectifies only one-half of the input ac wave to produce a varying/pulsing dc output. Compare with [Bridge-Rectifier](#).

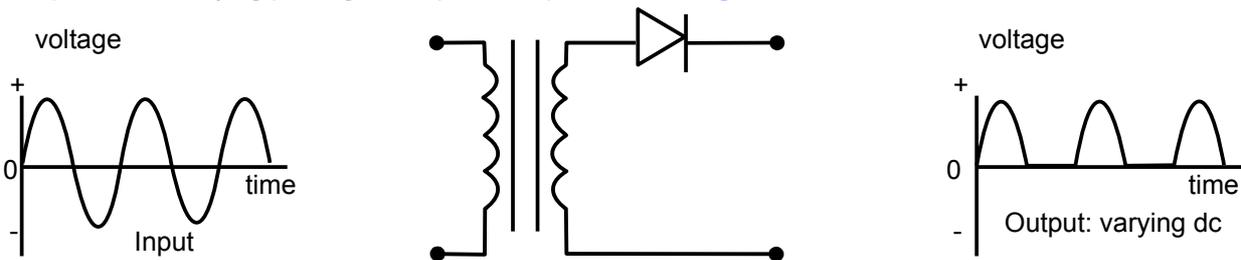

Drawing 14: Half-Wave Rectifier

Headroom – The difference between the [Bulk voltage](#) and the output voltage in a linear regulator.

Hecto – SI prefix multiplier. Multiplies by $10^2=100$. So 100 hHz = $100 \times 10^2 \text{ Hz} = 10000\text{Hz}$. Written as 'hecto'. Abbreviated to 'h'.

Henry (H) – Unit of measurement of [Inductance](#). Written as 'henry'. Abbreviated to H.

Hertz (Hz) – The [SI](#) unit of measurement for [Frequency](#), named in honour of Heinrich Hertz who discovered radio waves. One hertz equals one cycle per second. Written 'hertz'.

High Breaking Capacity (HBC) – A term relating to [fuses](#) which describes the level of current which the fuse will safely interrupt. This is usually 1500A minimum. Usual construction is a ceramic tube, filled with sand through which the fusible wire passes.

Hi-Pot Test (High Potential Test) – A safety critical test performed by applying a high voltage for a specified time to two isolated points to determine adequacy of insulating materials.

Hiccup Current Limit – When the output of a power supply exceeds certain limits, the control circuit will turn off the output, wait a period and then turn on the output once more. If the output current is still too high, this cycle is repeated until the power supply is turned off or the fault condition is removed.

High Line – Highest specified input operating voltage.

Highly Accelerated Life Testing - a process developed to uncover design defects and weaknesses in electronic and mechanical assemblies using a selection of parameters to stress the product (including vibration, temperature changes, ac input level, etc.). It is a technique that addresses reliability issues at an early stage in product development, offering significant advantages over more traditional techniques.

Highly Accelerated Stress Screening - used as part of the production process to detect component and manufacturing irregularities as early as possible. Similar stress parameters to [HALT](#) are used (such as rapid temperature cycling, [power cycling](#), vibration, etc.), but once the product parameters are known from the [HALT](#) process, testing in production is usually at lower levels so that product life is not reduced. This is applied to 100% of the manufactured units.

Holding Time – See [Holdup Time](#).

Holdup Time – The time, under worst case conditions, during which a power supply's output voltage remains within specified limits following the loss or removal of input power. Sometimes called [Holding Time](#).

HP – Unit of width (usually) in a 19 inch rack. 1 HP = 0.2 inches = 5.08mm. Same as TE. See [Useful Conversion Factors](#).

Hybrid – The combination of different component technologies on a single substrate.

Hybrid Supplies – A power supply (PSU) that combines two or more different regulation techniques, such as switching and linear, or one that takes advantage of hybrid technology. See also [Hybrid](#).

Hysteresis – 1) The property of a magnetic substance that causes magnetisation to lag behind the force that produces it.
 2) A variable voltage threshold determined by the logic state of the output of the circuit.

Hysteresis Loop – A curve that shows the values of the magnetic flux density in a cyclically magnetised material: one when the magnetising force is increasing, the other when it is decreasing. See [Remanence](#), [Coercivity](#).

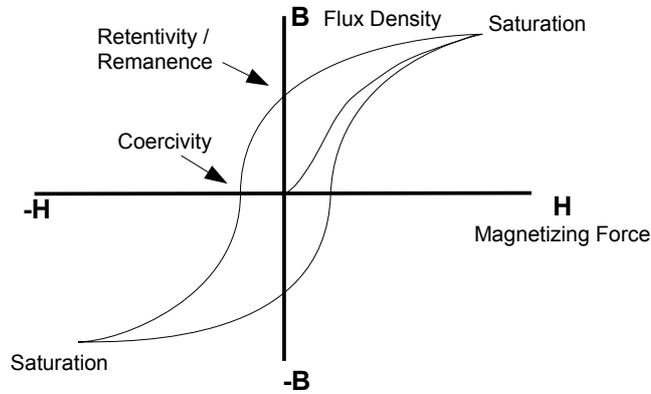

Drawing 15: Hysteresis Loop

Hysteresis Loss – Energy dissipated due to molecular friction as domains move through cycles of magnetisation.

I

- I** – Symbol for electric [Current](#).
- IC** – Abbreviation for [Integrated Circuit](#).
- IEC** – Abbreviation for [International Electrotechnical Commission](#).
- IECEE** – Abbreviation of **IEC** System for Conformity testing and Certification of Electrical Equipment. See [CB Scheme](#). (<http://www.iecee.org/>)
- IEE** – Abbreviation for [Institution of Electrical Engineers](#) (<http://www.iese.org>)
- IET** – Abbreviation for [Institute of Engineering and Technology](#) (<http://www.theiet.org>)
- IEEE** – Abbreviation for [Institute of Electrical and Electronic Engineers](#) (<http://www.ieee.org>)
- IEEE488** – The standard defining the [GPIB](#) (parallel communications bus). See [Communications Port](#).
- IIE** – Abbreviation for [Institution of Incorporated Engineers](#). Now part of the [Institute of Engineering and Technology](#)
- IMS** – See [Insulated Metal Substrate](#).
- IPC** – A “United States-based trade association dedicated to furthering the competitive excellence and financial success of its members worldwide, who are participants in the electronic interconnect industry.” Formerly known as 'Institute for Printed Circuits' and 'Institute for Interconnecting and Packaging Electronic Circuits'. See (<http://www.ipc.org>).
- IR Drop** – See [Voltage Drop](#).
- I²C** – Acronym for Inter-Integrated Circuit. A simple, serial communications bus designed by Philips suitable for communications inside a system. Often used to turn on/off a power supply (or supplies) in a system. See [Communications Port](#).
- I²R Loss** – See [Copper Loss](#).
- Impedance (Z)** – Total resistance to flow of an alternating current as a result of resistance and reactance.
- Imperial Standard Wire Gauge** – See [Standard Wire Gauge](#).
- Induced Current** – Current that flows as a result of an [Induced EMF \(Electromotive Force\)](#).
- Induced EMF** – Voltage induced in a conductor in a varying magnetic field.
- Inductance (L)** – The inherent reactive property, measured in henrys, of an electric circuit or circuit element that opposes a change in current flow. Hence, inductance causes current changes to lag behind voltage changes. See also [henry](#).
- Inductive Reactance (X_L)** – Opposition to a changing current as a result of inductance: $X_L = 2\pi FL$
- Inductor** – A coil or component with the properties of inductance.



Drawing 16: Schematic Symbol for an Inductor

- Inhibit** – A signal input to a power supply which will turn off the outputs (if the unit is fan cooled then this may also inhibit the fan). The signal has to be activated to make the outputs turn off, with nothing connected to the input, the power supply should operate. (Compare this with [Enable](#)).
- Input Impedance** – The impedance between the input terminals of a circuit or device, with the input disconnected.
- Input Line Filter** – A low-pass or band reject filter at the input of a power supply (PSU) that reduces line noise fed to the supply. This filter may be external to the power supply (PSU).
- Input Pi Filter** – See [Pi Filter](#).
- Input Surge** – See [Inrush Current](#).
- Input Voltage Range** – The range of input voltage values over which a power supply (PSU) or device will operate within its specified limits.
- Inrush Current** – The peak instantaneous input current drawn by a power supply (PSU) at turn on. In a switched mode power supply, there is no transformer reaction to limit the current that flows when the power supply is first switched on. An extremely large current can be drawn from the mains as the reservoir capacitors charge to the full voltage. To reduce this current to a sensible level, they often incorporate Inrush Current Limiting. This peak is usually restricted by inrush current limiting and only occurs for a short period of time (usually one cycle of ac) and occurs only if the power supply (PSU) is turned on at the peak of the ac cycle.
- Inrush Current Limiting** – The characteristic of a circuit that limits inrush current when a power supply (PSU) is turned on. Inrush Current Limiting is typically performed by either a thermistor (which when cold has a high resistance, when hot, a low resistance) connected in series with the ac supply, or by a relay which switches in a resistor until a defined period (a few milliseconds) has passed, or by a relay

which bypasses a series resistor or NTC after the initial start-up period has passed..

Inrush current limiting enables a power supply to meet IEC/EN61000-3-3 (flicker).

Instantaneous Value – The measured value of a signal at a given moment in time.

Institute of Electrical and Electronic Engineers (IEEE) – A US based professional organisation. The IEEE develops standards of definitions, test methods, symbols, units and safety in the field of electrical science and engineering. <http://www.ieee.org/>

Institute of Engineering and Technology – Institution formed in spring 2006 by the coming together of the [IEE](#) and the [IIE](#).

Institution of Electrical Engineers (IEE) – A UK based professional organisation. The IEE develops standards of definitions, test methods, symbols, units and safety in the field of electrical science and engineering. Now part of the [Institute of Engineering and Technology](#).

Institution of Incorporated Engineers (IIE)- Now part of the [Institute of Engineering and Technology](#).

Insulated Metal Substrate – A [Printed Circuit Board](#) where the substrate is metal (usually aluminium but sometimes copper or other metal) covered with a thin layer of insulating material (epoxy based) and then a layer of copper (from which the required conducting tracks are created). IMS has excellent thermal conductance and is used where cooling is necessary (especially for [Surface Mount Devices](#)).

Insulation – Non-conductive materials used to separate electrical circuits and to prevent electric shock.

Insulation Resistance – The resistance, usually measured in megaohms, of an insulating material.

Insulator – material that prevents the flow of electricity.

Integrated Circuit (IC) – Multiple components (both active and passive) manufactured on a single semiconductor substrate (usually silicon).

Integrated Magnetics – Multiple magnetic components assembled as a single assembly. Used on TDK-Lambda's EFE product range to increase efficiency and reduce the size of the power supply.

Intermittent Duty – operation for specified alternate intervals of load and no load. See also [Continuous Duty](#).

Internal Impedance – The [impedance](#) exhibited by a power supply or electronic device.

Internal Resistance – See [Internal Impedance](#)

International Electrotechnical Commission (IEC) – Organisation that prepares and publishes international standards for electrical, electronic and related technologies. The standards cover safety, performance, EMC and environmental. The IEC does not perform any testing; this function is left to the national testing agencies. National standards are frequently based on IEC publications. See <http://www.iec.ch/>

Inverter – 1) A device that changes dc into ac (sometimes called dc-ac converters)

2) A circuit, circuit element or device that inverts the input signal.

Iron Core – A general class of core that contains iron. Sometimes used to refer to cores made only from steel laminations. See also [Core](#), [Ferrite](#), [Powdered Iron Core](#).

Isolation – The electrical separation between two circuits, or circuit elements.

Isolation Transformer – A transformer (usually with a one-to-one turns ratio) used as a safety device to isolate a device under test from earth. Alternatively used to block the transmission of DC signals whilst allowing the ac to pass. See also [Step-Down Transformer](#), [Step-Up Transformer](#), [Transformer](#).

Isolation Voltage – The maximum ac or dc specified voltage that may be continuously applied between isolated circuits.

J

J – Abbreviation for [joule](#).

JDEC – Abbreviation for [Joint Electronic Device Engineering Council](#).

JFET – Abbreviation for [Junction Field Effect Transistor](#). See also [Field Effect Transistor](#).

Joint Electronic Device Engineering Council (JDEC) – A group within the Electronic Industries Association, originally formed in conjunction with [NEMA](#). No longer affiliated with [NEMA](#), the [EIA](#) group has retained the **JDEC** acronym.

Joule (J) – Unit of [energy](#) equal to one watt second. Written as 'joule'. Abbreviated to **J**.

Junction Field Effect Transistor (JFET) – A usually low power semiconductor (although high power SiC JFETs are being investigated) having a conductive channel whose resistance is controlled by the reverse voltage on the gate channel junction. See [Field Effect Transistor](#).



Drawing 17: Schematic Symbols for J-FETs

K

K – The abbreviation for [kelvin](#).

kW – Abbreviation for [kilowatt](#).

kWh – Abbreviation for [kilowatt-hour](#).

Kelvin (K) – 1) Unit of temperature in the International System of Units ([SI](#)). Written as 'kelvin'. Abbreviated to K. See [Convert Kelvin to degrees Celsius](#).

2) a 4 terminal connection method used to isolate current carrying leads from voltage measuring (sense) leads (used to eliminate voltage drop along the sense leads).

Kilo – SI prefix multiplier. Multiplies by 10^3 . So 100 kHz = 100×10^3 Hz = 100000 Hz. Written as 'kilo'. Abbreviated to 'k'.

kilowatt – 1000 [watts](#).

kilowatt-hour – A unit of energy (non [SI](#)). Abbreviated to kWh. See [Useful Conversion Factors](#).

L

L – The symbol for [Inductance](#), and the abbreviation for litre and length.

L-C Filter – A low pass filter consisting of an inductance (L) and a capacitance (C). Also known as an averaging filter.

LED – Abbreviation for [Light-Emitting Diode](#).

LVD – Abbreviation for [Low Voltage Directive](#)

Latch – A logic circuit that, once set, maintains the output at some fixed state until reset.

Latching Relay – A relay that mechanically latches until mechanically or electrically reset.

Lead-Free Directive – See [Restriction of Hazardous Substances Directive](#).

Lead Resistance – Dc resistance of the leads of a circuit element or device.

Leakage Current – The ac or dc current flowing from input to output and/or chassis of an isolated device at a specified voltage. Also the off-state current in a switching device (diode, transistor, etc.) See also [Earth Leakage Current](#).

Light-Emitting Diode (LED) – A semiconductor device which emits light when an electric current is passed through it. The colour is determined by the properties of the materials and dopants used.

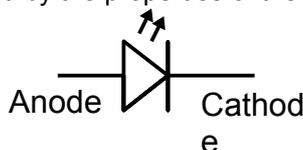

Drawing 18: Schematic Symbol for LED

Life Test – Estimating life expectancy of a device by subjecting it to accelerated or actual use.

Line – The voltage across a power transmission line. See also [High Line](#), [Low Line](#).

Line Conditioner – A circuit or device designed to improve the quality of an ac line.

Line Effect – See [Line Regulation](#).

Line Regulation - The amount that the output voltage changes as a result of changing the input voltage.

Typically specified as a percentage change of the output for a given input voltage change with all other factors held constant. See also [Regulation](#).

Linear – 1) in a straight line.

2) quantities varying in direct proportion to one another.

Linear Power supply – See [Linear Supply](#).

Linear Regulation – A regulation technique where the control device, such as a transistor, is placed in series (series regulation) or parallel (shunt regulation) with the load. The output is regulated by varying the resistance of the control device to dissipate unused power. See also [Linear Supply](#).

Linear Regulator – A voltage regulator where a transistor (or [Zener Diode](#), or other device) is used to control the output voltage. This method of regulation is inherently inefficient as the regulating device (transistor, etc.) is dropping volts at the full output current. Therefore wasted power = volts dropped x output current. For low current outputs, this wasted power is often not significant but for high current outputs, this wasted power can be very considerable and leads to the use of a [Switched Mode Power Supply](#).

Linear Supply – An electronic power supply (PSU) employing [Linear Regulation](#).

Line Transient – A perturbation outside the specified operating range of an input or supply voltage.

Litz Wire – Wire that consists of many thin, separately insulated wire strands woven together. It increases the surface area of the wire and reduces the skin effect and power losses when used in high-frequency applications.

Live - Electrically connected to a voltage source or electrically charged so as to have a voltage different from that of earth.

Load – Any combination of resistance, capacitance and inductance connected to the output of a power supply. It determines the requirements of the power supply (current, voltage, start up requirements, etc.).

Load Decoupling – Using filter components at the load to attenuate noise. See [Decoupling](#).

Load Effect – See [Load Regulation](#).

Load Impedance – The [Impedance](#) to the flow of current posed by the load.

Load Regulation – The percentage change in output voltage as the load is changed from a specified minimum to maximum (or maximum to minimum), with all other factors held constant. See also [Regulation](#).

Load Transient Overshoot – See [Overshoot](#).

Load Transient Response Time – See [Transient Recovery time](#).

Local Sensing – Using the power supply (PSU) output voltage terminals as the voltage sensing points to provide feedback to the voltage regulator. Benefit is only 2 wires connected to load, drawback is does not correct for voltage drop in the connecting leads. Compare with [Remote Sensing](#).

Logic Ground – Common return or reference point for logic signals.

Logic High – A voltage representing a logic value of one (1) in positive logic. The absolute voltage level varies depending on the technology. For example, CMOS 3.7V is minimum for logic High, TTL = 2.0V.

Logic Enable/Inhibit – A referenced or isolated logic signal that turns a power supply (PSU) on or off.

Logic Low – A voltage representing a logic value of zero (0) in positive logic. The absolute voltage level varies depending on the technology. For example, CMOS 1.3V is maximum for logic low, TTL = 0.8V.

Long-Term Stability – The output voltage change of a power supply (PSU), in percent, due to time only, with all other factors held constant. Long-term stability is a function of component ageing (capacitors drying out, etc.).

Low Line - Lowest specified input operating voltage.

Low Voltage Directive (LVD) - Applies to all electrical equipment designed for use with a voltage rating of between 50 and 1000 V AC and between 75 and 1500 V DC. Broadly the scope of the LVD covers all products operating within those voltage limits with a few exceptions.

M

MEG – Acronym for [Multiple Efficiency Gain](#).

MOSFET – Acronym for [Metal Oxide Semiconductor Field Effect Transistor](#).

MOV – Abbreviation for [Metal Oxide Varistor](#).

MRT – Abbreviation for [Multi-Resonant Topology](#).

MTBF – Abbreviation for [Mean Time Between Failure](#).

MTTR – Abbreviation for [Mean Time To Repair](#).

Magnetic Amplifier (Mag Amp) – Part of the output control for a power supply. A special type of inductor with a very square hysteresis loop. Used as a regulating switch to control the output voltage.

Magnetic Gap – See [Air Gap](#).

Margining – Adjusting the output voltage by a specified amount for system testing or other use.

Master/Slave Operation – Two or more regulated power supplies connected such that one (the master) controls the others (the slaves).

Maximum Load – 1) The highest allowable output rating specified for any or all outputs of a power supply (PSU) under specified conditions including duty cycle, period and amplitude.

2) The highest specified output power rating of a power supply (PSU) specified under worst case conditions.

Mean Time Between Failure (MTBF) – The average length of time between system failures, exclusive of infant mortality and rated end-of-life. Established methods of calculating MTBF are described in the most recent edition of Mil Handbook 217 or according to Telcordia. Two key factors which affect the MTBF are the ambient temperature at which the power supply is used and the component count. Adding components that actually increase the reliability of a unit (such as clamping diodes, snubbers, etc.) can lower the calculated MTBF figure. It is important to note that this figure is vulnerable to 'specmanship' from some manufacturers who may wish to make their power supplies look better than they should be.

Mega – SI prefix multiplier. Multiplies by 10^6 . So 1 MHz = 1×10^6 Hz = 1000000 Hz. Written as 'mega'. Abbreviated to 'M'.

Metal Oxide Semiconductor Field Effect Transistor (MOSFET) – A type of [Field Effect Transistor](#) whose channel is insulated from its gate with an [insulator](#) (typically SiO_2). It is the most commonly used type of FET and is used in all [CMOS](#) circuits.

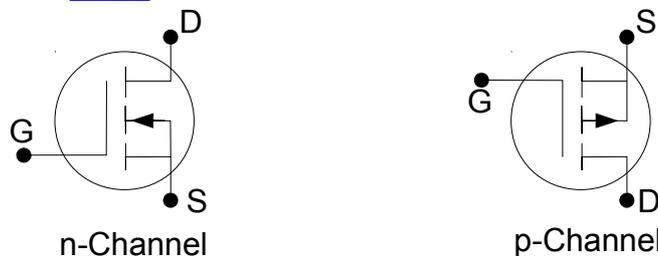

Drawing 19: Schematic Symbols for an MOSFETs

Metal Oxide Varistor (MOV) – Common type of [Varistor](#). A two terminal device with a resistance which is high at low voltages and low at high voltages.

Mho – Obsolete (now replaced by [siemens](#)) unit of measurement of [Conductance](#)

Micro – SI prefix multiplier. Multiplies by 10^{-6} . So $100 \mu\text{F} = 100 \times 10^{-6} \text{ F} = 0.0001 \text{ F}$. Written as 'micro'. Abbreviated to ' μ '.

Milli – SI prefix multiplier. Multiplies by 10^{-3} . So $100 \text{ mF} = 100 \times 10^{-3} \text{ F} = 0.1 \text{ F}$. Written as 'milli'. Abbreviated to 'm'.

Minimum Load – The lowest current that must be drawn from a power supply (PSU) for the power supply to operate within specification.

Minimum Operating Temperature – The lowest ambient temperature at which the power supply (PSU) will continuously operate safely and within specifications.

Minimum Startup (or Starting) Temperature – The lowest ambient temperature at which a power supply (PSU) will turn on and operate safely (although not necessarily to full specification).

Minus (-) – Negative terminal of a power supply (PSU).

Modular Power Supply – A power supply (PSU) made up of a number of separate building blocks such as output modules. Each module is usually selectable to closely match the requirements. Normally, each

module is galvanically isolated. TDK-Lambda's Vega, NV-350 & NV-700 are industry leading examples of modular power supplies.

Multi-Resonant Topology (MRT) – A switched mode power supply topology used in modern design, high efficiency, switched mode power supplies. Rather than using [magamp](#) post regulators and two-stage conversion, MRT uses closed loop control of the main outputs, a single conversion stage and auxiliary channels employing high efficiency dc-dc post regulation. The inherent low internal voltages on the secondary side allow the use of low voltage synchronous rectifiers with much lower losses, thus improving the efficiency. This topology allows the use of smaller inductors and wound components. The use of MRT over more traditional [magamp](#) regulation can offer up to 5% efficiency improvement for multiple output power supplies. TDK-Lambda's NV-Power range utilises MRT to provide units which have high efficiency.

Multimeter – A meter capable of measuring current, voltage and resistance.

Multiple Efficiency Gain – a technology introduced with TDK-Lambda's NV-Power range of products to achieve industry leading efficiency for multiple-output power supplies. Efficiency improvements at various stages of the power supply multiply together producing the compound effect of Multiple Efficiency Gain.

Multiple Output Power Supply – A [power supply](#) (PSU) with two or more outputs.

N

NEMA – Acronym for [National Electrical Manufacturers Association](#).

NTC – See Negative Temperature Coefficient.

Nano – SI prefix multiplier. Multiplies by 10^{-9} . So 100 nF = 100 x 10^{-9} F. Written as 'nano'. Abbreviated to 'n'.

National Electrical Manufacturers Association (NEMA) - Industry trade organisation “providing a forum for the standardisation of electrical equipment” with headquarters in Rosslyn, Virginia. See <http://www.nema.org/>.

Negative Rail – The more negative of the two conductors at the output of a [power supply](#) (PSU).

Negative Temperature Coefficient (NTC) – A function which decreases with increasing temperature. Usually relates to resistance but may also refer to capacitance, voltage, etc.

Neutral – The ac return somewhere connected to ground, but which should not be used for ground because it is a current carrying path.

No Load Voltage – Voltage at the output terminals of a [power supply](#) (PSU) when no current is flowing. See [Open Circuit Voltage](#).

Noise – The random component on a power supply's output which is unrelated to source and switching frequency. Noise is usually expressed in peak-to-peak units over a specified bandwidth (unless specified otherwise).

Noise Filter – See [Filter](#).

Nominal Value – The stated value. Note, this may well be different to the measured value.

Nominal Voltage – The stated value of a voltage, this may well be different to the measured value (for many reasons, including setting accuracy, etc.).

O

OCV – Abbreviation for [Open-Circuit Voltage](#).

OP-AMP – Abbreviation for [Operational Amplifier](#).

OVP – Abbreviation for [Overvoltage Protection](#).

Off-Load Voltage – See [Open-Circuit Voltage](#).

Ohm (Ω) – Unit of measurement of [Resistance](#) and [Reactance](#). Written as 'ohm'. Abbreviated to Ω .

Ohm's Law – The fundamental mathematical relationship between current (I), voltage (E) and resistance (R) discovered by George Simon Ohm. The passage of one ampere through one ohm produces one volt. See [Resistance and Ohm's Law](#).

Open-Circuit Voltage (OCV) – The voltage when the circuit is open (no-load condition). See [No Load Voltage](#).

Open-Frame Construction – A construction technique where the power supply (PSU) is not provided with an enclosure. Particular care needs to be exercised when installing an open frame power supply to ensure that adequate spacings and shock protection is maintained. Additional care needs to be taken to ensure that the unit is installed to meet the EMC standards (see [Installation for optimum EMC performance](#)) and thermal performance.

Operating Temperature Range – The range of temperatures (ambient, baseplate or case) over which a power supply (PSU) is specified to operate safely and to perform within specified limits. See also [Ambient Temperature](#), [Storage Temperature](#).

Operational Amplifier (OP-AMP) – A high gain differential input semiconductor device that measures the error voltage and produces at its output an amplified version of this.

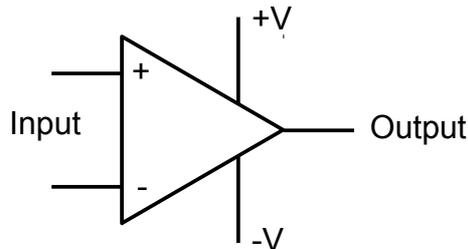

*Drawing 20: Schematic Symbol for an Op-Amp
(often the +V and -V are omitted)*

Opto-Coupler – A package that contains a light emitter and a photoreceptor used to transmit signals between electrically isolated circuits. Used in power supplies to ensure that the [Status Signals](#) presented by the PSU and control signals with the PSU are isolated from the outputs.

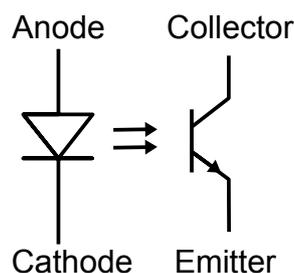

Drawing 21: Schematic Symbol for an Opto-Coupler

Opto-Isolator – See [Opto-Coupler](#).

Output – The energy provided by the power supply or the terminals on the power supply which provide the output power.

Output Choke – The inductor in the output [L-C Filter](#).

Output Current Limiting – A protective feature that keeps the output current of a power supply (PSU) within predetermined limits during overload to prevent damage to the supply or the load. Power supply current limiting is usually designed to protect the power supply, not the load and it is advisable that the system designer ensures that the system is protected in the event of excess current.

Output Filter – Components used to attenuate output ripple and noise.

Output Filter Capacitor – The capacitor(s) across the output terminals of a power supply (PSU).

Output Impedance – See [Internal Impedance](#).

Output Inductance – See [Output Choke](#).

Output LC Filter – The low pass filter in the output of a power supply (PSU) that smooths the rectified output to its average value. Also called an averaging filter.

Output Range – The specified range over which the value of an output (voltage or current) can be adjusted.

Output Ripple and Noise – See [Periodic and Random Deviation](#).

Output Voltage – The voltage measured at the output terminals of a power supply (PSU).

Overcurrent Protection – See [Output Current Limiting](#).

Overload Protection – A feature that senses and protects the power supply from current or power overload conditions. See also [Output Current Limiting](#).

Overshoot – A transient change in output voltage in excess of specified output regulation limits, which can occur when a power supply (PSU) is turned on or off, or when there is a step change in line or load.

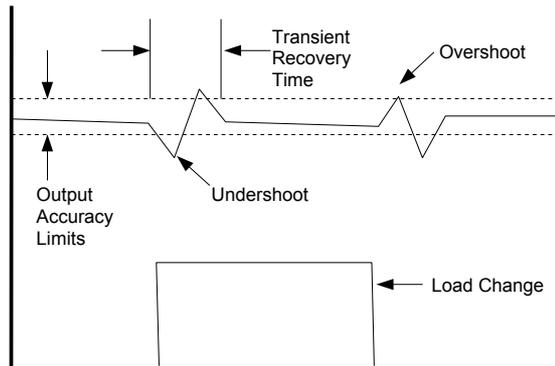

Drawing 22: Overshoot, Undershoot & Transient Recovery Time

Overvoltage – A voltage that exceeds specified limits.

Overvoltage Protection (OVP) – A feature that detects a high voltage condition and protects the circuit as necessary. See also [Overvoltage](#), [Crowbar](#).

P

P – the abbreviation for [Power](#).

PARD – Acronym for [Periodic and Random Deviation](#).

PCB – Abbreviation for [Printed Circuit Board](#).

PFC – Abbreviation for [Power Factor Correction](#).

POL converter – Abbreviation for [Point of Load Converters](#).

POLA – Abbreviation for [Point of Load Alliance](#)

PWM – Various, the abbreviation for [Pulse-Width Modulation](#), [Pulse-Width Modulator](#).

Parallel – 1) when 2 or more power supply outputs (of the same voltage) are connected together, +ve to +ve and -ve to -ve to increase the total output current (whilst maintaining the output voltage). Care should be taken to ensure that the power supply is suitable for parallel connection as some units will not operate well or may be destroyed by operating in this manner. Additionally, some power supplies need diodes connected in series with their outputs to operate correctly in parallel, check the operation/installation manual for details.

2) The connection of components or circuits in a shunt configuration.

Parallel Resonant Circuit – Network of resistors, a capacitor and an inductor connected as shown below.

See also [RLC Circuits \(Parallel Resonant\)](#).

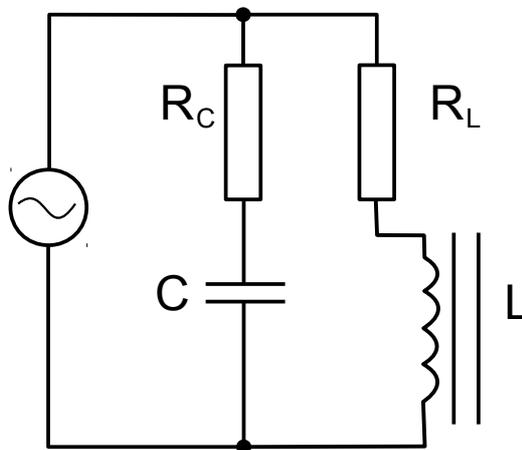

Drawing 23: Parallel Resonant Circuit

Parallelable – Term to describe power sources that may be connected in [Parallel](#).

Peak – Maximum value of a waveform.

Peak-To-Peak – The measured value of a waveform from peak in a positive direction to peak in a negative direction.

Periodic and Random Deviation (PARD) – The sum of all ripple and noise components measured over a specified bandwidth and stated, unless otherwise specified, in peak-to-peak values.

Peta – SI prefix multiplier. Multiplies by 10^{15} . So 100 PHz = 100×10^{15} Hz. Written as 'peta'. Abbreviated to 'P'.

Pi Filter – A filter consisting of two line-to-line capacitors and a series inductance in a π configuration used to attenuate noise and ripple.

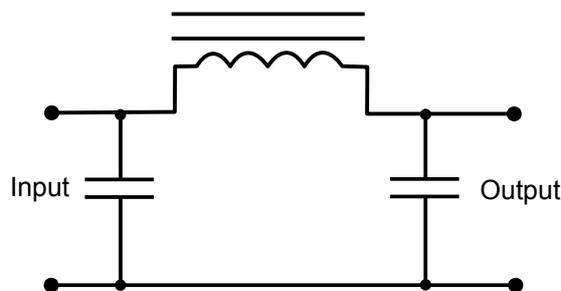

Drawing 24: Pi Filter

Pico – SI prefix multiplier. Multiplies by 10^{-12} . So 100 pF = 100×10^{-12} F. Written as 'pico'. Abbreviated to 'p'.

Plated Through Hole – A hole in a [PCB](#) which has a conductive material deposited on the walls. Also called “[Vias](#)” or “Through Plated Holes”.

Plus (+) – Positive terminal of a circuit, circuit element or power source.

Point of Load Alliance – POLA alliance members develop and market new plug-in modules with the same functionality and form factors as those provided by other members of the POLA alliance.

Point of Load Converters (POL) – Non isolated [dc-dc converters](#). They benefit from being lower cost than isolated dc-dc converters and normally smaller and higher efficiency. TDK-Lambda PL range are compact, high efficiency examples of POL converters.

Positive Rail – The most positive of the two output conductors of a power supply (PSU).

Post Regulation – The use of a secondary regulator on a power supply (PSU) output to improve line/load regulation and to attenuate ripple and noise.

Pot – Abbreviation for [potentiometer](#).

Potentiometer (pot) – A component with an adjustable resistance (an adjustable or variable resistor).

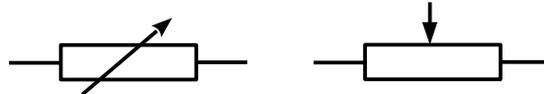

Drawing 25: Schematic Symbols for a Potentiometer

Potting / Potting Compound – An insulating material for encapsulating one or more circuit elements.

Potential Difference – (Electrical Potential Difference) – the voltage between two points causing a current to flow in a circuit.

Powdered Iron Core – Magnetic core material that contains iron particles held together with a high resistance binder to reduce eddy currents. See also [Core](#), [Ferrite](#), [Iron Core](#).

Power (P) – 1) the rate of doing work, measured in watts. $P = E I = I^2 R = \frac{E^2}{R}$

2) In a resistive circuit, power is the product of the in-phase components of voltage and current (volt-amperes). See also [Apparent Power](#), [True Power](#).

Power Cycle – A rigorous test which is designed to apply controlled strenuous test conditions to an assembled power supply, ensuring that any defects present are identified and resolved before delivery to the customer. Typically, the power cycle will operate the power supply at elevated temperature into a full load, simulating worst case conditions. The power is then turned on and off repeatedly at both high and low line input levels. It has been shown that this type of test is much more effective at discovering latent defects than the traditional burn-in procedure. See also [Burn In](#).

Power Density – The ratio of the power available from a power source to its volume. E.g. watts/inch³.

Power Factor – The ratio of [True Power](#) to [Apparent Power](#) as a decimal, occasionally specified as lead or lag of the current relative to voltage.

Power Factor Correction – A technique to counteract the effect caused by loads that have a power factor below 1 (less than 100%). Power factor correction is necessary as it increases the efficiency of power transmission. A low power factor load increases losses in the transmission lines. Passive PFC uses an inductor to pass current at the supply frequency (usually 50Hz or 60Hz) with additional capacitors to bring the power factor close to 1. Active PFC usually employs a [Boost Converter](#) between the bridge rectifier and the reservoir capacitors to maintain the power factor close to 1. Active PFC usually provides [wide range input](#) to the power supply.

Power Fail Signal – A [Status Signal](#) from a power supply (PSU) that provides advance notice that the output voltage is about to fall out of specifications due to loss of line.

Power Failure Signal - See [Power Fail Signal](#).

Power FET – A [field effect transistor](#) specifically designed for high current/power applications.

Power Good Signal – A [Status Signal](#) from a power supply (PSU) that power is within predetermined specifications.

Power Rating – Power available at the output terminals of a power supply based on the manufacturer’s specifications.

Power Source – A device that provides electrical power, including a power supply (PSU), battery, generator, etc.

Power Status Signals – See [Status Signals](#).

Power Supply (PSU) – A device which supplies electrical energy to a load. Typical application of power supplies include to convert raw input power (can be either [ac](#) or [dc](#)) to a controlled or stabilised voltage and/or current for the operation of electronic equipment. Often used to convert between hazardous voltages available from wall sockets (usually 110Vac or 230Vac) to voltages which can be used by electronic equipment (CPU's, motors, telephones, etc.).

There are many types of different power supplies including [Linear Supplies](#), [Switched Mode Power Supplies](#), [DC-DC converters](#), [Programmable Power Supplies](#) . TDK-Lambda is able to supply many different types of power supplies to meet your requirements from only a few watts up to 60kwatts.

Power Supply Cord – a length of flexible cord provided with an attachment plug at one end. See also [Cord Set](#).

Primary Winding – The driven coil in a transformer.

Printed Circuit Board (PCB) – An insulating substrate with conductive (usually copper) tracks connecting components. The PCB is used to both support and interconnect components. PCBs are made of many materials including resin impregnated paper (often called [FR-2](#)), fibreglass ([FR-4](#)), various plastics (more commonly used for high power RF circuits), ceramic or metal (usually aluminium – see [IMS](#)). PCBs can have one or more layers of copper tracks and the different layers are connected with [Vias](#). Additional layers make the PCB cost more but have benefits (such as improving the [EMC](#) performance, improving heat conduction and reducing size).

Programming – The control of a power supply (PSU) parameter, such as output voltage or Current, by means of a control element or signal (This is either done with digital control [by [Communications Port](#)] or analogue control [with resistance or voltage input to the programming pins on the power supply]).

Programmable Power Supply – A power supply (PSU) with an output (or outputs) controlled by an applied voltage, current, resistance or digital code. TDK-Lambda's ZUP and Genesys are examples of digitally, remote programmable power supplies (available with output powers from 200W up to 60kW). TDK-Lambda's Vega range is available with remote programmable output modules.

Programming Speed – a power supply's ability to respond to a command to change its output setting from one level to another. It can be measured in terms of a programming time constant and a slewing rate.

Programming Time – Time between the start of a programmed event and arrival within a specified range of the final value. Unless otherwise specified, 95% of the desired change should be used.

Pulse – A step rise, a level, and a step fall of voltage or current. Characteristics of a pulse are: rise time, duration (or dwell time) and fall time.

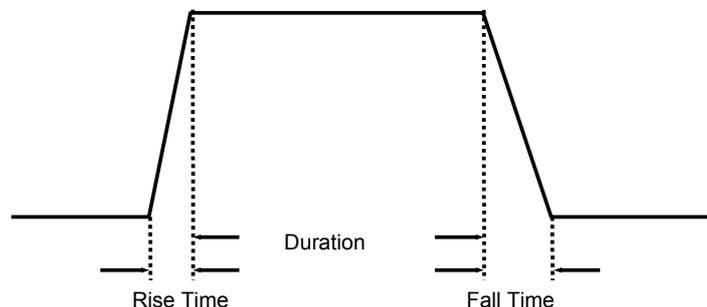

Drawing 26: Pulse

Pulse Discharge – A non-continuous discharge.

Pulse-Width Modulation (PWM) – regulation of the output voltage of a switched mode power supply (SMPS) by varying the duration, but not the frequency, of the pulses that drive the power switch.

Pulse-Width Modulator – An circuit performing [Pulse-Width Modulation](#) .

Q

Quarter Brick - Industry standard footprint for dc-dc converters. Dimensions are 57.9mm x 36.8mm (2.3in x 1.5in). See also [Full Brick](#), [Half Brick](#), [Eighth Brick](#), [Sixteenth Brick](#). TDK-Lambda's PAQ range of dc/dc converters are examples of quarter bricks.

R

R – Abbreviation for [Resistance](#).

RC – Abbreviation for resistance-capacitance (usually referring to [filters](#)).

RF – Abbreviation for Radio Frequency.

RFI – Abbreviation for [Radio Frequency Interference](#).

rms Value – Abbreviation for [Root Mean Square Value](#).

RoHS – Abbreviation of [Restriction of Hazardous Substances](#) (Directive).

RS232 – A standard for serial communications. Suitable for connecting one DTE (data terminal equipment [often a computer]) and one DCE (Data Communication Equipment [could be a power supply, or a modem, etc.]). See [Communications Port](#).

RS485 – A standard for serial communications. Suitable for connecting a controller to one or more pieces of equipment [such as a power supply]. Can be used to connect equipment over relatively large distances (1km). See [Communications Port](#).

Radio Frequency Interference – An unwanted conducted or radiated signal. See also [Electromagnetic Interference](#).

Rail – Either conductor of the output of a power supply. See [Positive Rail](#), [Negative Rail](#).

Rated Output Current – The maximum continuous load current a power supply (PSU) is designed to provide under specified operating conditions.

Reactance – In an ac circuit, reactance is the imaginary part of impedance. It is caused by the presence of inductors or capacitors in the circuit. Reactance is denoted by the symbol X and is measured in [ohms \(\$\Omega\$ \)](#).

Recovery Time – The time required for the measured characteristic to return to within specified limits following an abnormal event. See [Overshoot](#).

Rectification – The process of changing an alternating current to a unidirectional current. See [Full-Wave Rectifier](#), [Half-Wave Rectifier](#).

Rectifier – A component that passes current only in one direction. E.g. a diode.

Redundancy – Use of multiple devices or modules to provide continued operation following most failures in a single module device.

Reference Ground – Defined point in a circuit or system from which potential measurements are made.

Reference Voltage – The defined or specified voltage to which other voltages are compared.

Regulated Power Supply – A device that maintains a constant output voltage or current within specified limits for specified changes in line, load, temperature or time.

Regulation – The process of holding selected parameters constant, the extent of which is expressed as a percent. Includes [Voltage Regulation](#), [Line Regulation](#), [Load Regulation](#), [Cross Regulation](#).

Regulator – The power supply (PSU) circuit that controls or stabilises the output parameter at a specified value.

Reinforced Insulation – Insulation with such mechanical and electrical qualities that it, in itself, provides the same degree of protection against electrical shock as double insulation. It may consist of one or more layers of insulating material. It is acceptable in place of double insulation. See [Basic Insulation](#), [Double Insulation](#), [Supplementary Insulation](#).

Relay – A magnetic component or solid state device that opens or closes an isolated switch or switches when a voltage is applied to the control terminals.

Remanence – A measure of the remaining magnetization when the driving field is dropped to zero. See [Hysteresis Loop](#), [Coercivity](#).

Remote Enable/Inhibit – A logic signal applied to a power supply (PSU) to turn the unit on or off.

Remote Margining – See [Margining](#).

Remote Programming – See [Programming](#).

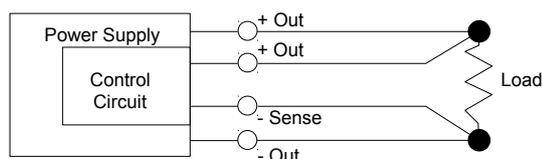

Drawing 27: Remote Sensing

Remote Sensing – A method to regulate the output voltage of a power supply (PSU) at the load by connecting the control circuit error-sensing leads directly to the load. Remote sensing compensates for specified maximum voltage drops in the load leads. Care should be taken to avoid opening load

handling leads to avoid damaging the power supply (PSU). Polarity must be observed when connecting sense leads to avoid damaging the system. The sense leads carry very little current and steps should be taken to ensure that they do not pick up noise. They should either be screened or, if this is not possible, twisted together to minimise the noise pick-up. Typically remote sensing is capable of adjusting for around 0.5V of drop in the connecting cables.

Required Headroom – The minimum voltage (above the required output voltage) supplied to a regulator, at which the regulator can provide the specified output.

Resistance (R)– A measure of how much a component (or other object) opposes the flow of current. The unit of resistance is the [ohm \(\$\Omega\$ \)](#).

Resistor – A two terminal component with a defined resistance.

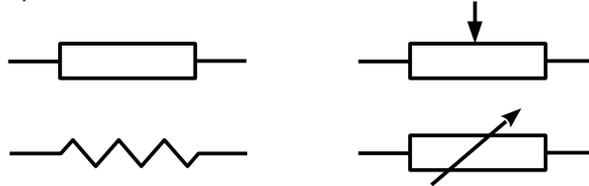

Drawing 28: Schematic Symbols for a Resistor and Variable Resistor

Resonant Converter – A class of converters that uses a resonant circuit as part of the regulation loop.

Resonant Frequency – The natural frequency at which a circuit oscillates or a device vibrates. In an L-C circuit, inductive and capacitive reactances are equal at the resonant frequency.

Response Time – The time required for the output of a power supply (PSU) or circuit to reach a specified fraction of its new value after a step change or disturbance.

Restriction of Hazardous Substances Directive (RoHS) – Often called the “lead-free” directive but it also covers maximum allowable concentration levels of 6 substances (Lead, Mercury, Cadmium, Chromium VI [Cr6+ or hexavalent chromium], PBB [polybrominated biphenyls] and PBDE [polybrominated diphenyl ether]). The maximum allowable concentration for Cadmium is 0.01% for the other 5 substances it is 0.1% by weight of homogeneous material. See also [Waste Electrical and Electronic Equipment Directive](#).

Retentivity – See [Remanence](#).

Return – The name for the common terminal of the output of a power supply (PSU), it carries the return current for the outputs.

Reverse Voltage Protection – A circuit or circuit element that protects a power supply (PSU) from damage caused by a voltage of reverse polarity applied at the input or output terminals.

Ripple – The periodic ac component at the power source output harmonically related to source or switching frequencies. Unless specified otherwise, it is expressed in peak-to-peak units over a specified bandwidth.

Ripple and Noise – See [Period and Random Deviation \(PAR\)](#).

Rise Time – The time required for a pulse to rise from 10% to 90% of its maximum amplitude.

Root Mean Square (RMS) Value – For a sine wave = $\sqrt{2}$ x Peak Value.

Rotary Encoder - An electronic component (usually used as a control input) which converts rotary motion into a series of electronic pulses. Used in the Z-UP and Z+ ranges of power supplies to enable intuitive user control of features of the power supply including voltage setting and current limit.

S

s – Abbreviation for second.

SCC – Abbreviation for [Short Circuit Current](#).

SCR – Abbreviation for [Silicon-Controlled Rectifier](#).

SELV – Abbreviation for [Safety Extra Low Voltage](#).

SI – Abbreviation for [System International d'Unites](#).

SiC – Abbreviation for [Silicon Carbide](#).

SMD – Abbreviation for [Surface Mount Devices](#).

SMPS – Abbreviation for [Switched Mode Power Supply](#).

SPS – Abbreviation for [Standby Power Supply](#).

SWG – Abbreviation for [Standard Wire Gauge](#).

Safety – Power supplies play an essential role in the safety of most electronic systems. They are the interface between the dangerous voltages of the mains supply and the low voltages used in the user/equipment interface. Because of this, many safety standards focus on the power supply as the item to ensure safe operation.

Safety Approvals – See [Safety Approvals](#) Section.

Safety Approved - Certification, recognition or approval by safety agencies such as [BSI](#), [TUV](#), [VDE](#), [UL](#), [CSA](#), etc.

Safety Compliance – Complies with the various safety requirements of the product or power supply.

Safety Earth – See [Safety Ground](#).

Safety Extra Low Voltage (SELV) – Internationally recognised safe voltage level which can be touched by a user. IEC define it as “voltage which does not exceed 50 V ac. or 120 V ripple-free dc. between conductors, or between any conductor and earth, in a circuit which is isolated from the supply mains by such means as a safety isolating transformer”.

Safety Ground – A conductive path from a chassis, panel or case to earth to help prevent injury or damage to personnel and equipment.

Safety Standards – See [Safety Approvals](#)

Schottky Diode – A diode that exhibits a low forward voltage drop and fast recovery time relative to a standard silicon diode.

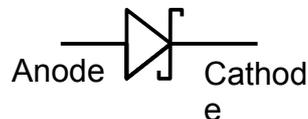

Drawing 29: Schematic Symbol for a Schottky Diode

Secondary circuit – A circuit which has no direct connection to a primary circuit and derives its power from a transformer, converter or equivalent isolation device, or from a battery.

Secondary Output – An output of a switching power supply (PSU) that is not sensed by the control loop. See also [Semi-regulated Output](#).

Secondary Winding – A coil that receives energy from the primary winding by mutual induction and delivers energy to the load.

Semi-regulated Output – A subjective term indicating partial regulation (usually applies to secondary outputs of a [Multiple Output Power Supply](#)). Typically with semi-regulated outputs, the [Cross Regulation](#) specification is poor (or not specified at all), the [Load Regulation](#) specification is poor (for example, if a power supply can provide more than 1A and the specification is +/-5% or worse then this is likely to be a semi-regulated output). Power supplies with semi-regulated outputs often have a [Minimum Load](#) requirement on at least one of the outputs.

Semi-regulated outputs may well be acceptable for most applications, however, some things to be aware of and consider before using a semi-regulated output:-

If you have a variable load on the power supply then all semi-regulated outputs will have transients on the output at the same frequency as the load variations.

If the load on a semi-reg o/p is removed (or reduced) then the output will increase. On some power supplies, this can be as much as 30% or more!!!

If you use remote sense on the main (usually fully regulated) output, then all semi-regulated outputs could vary by a similar amount (depending on exact design). For example, with a 3V channel 1, if you have 0.5V of remote sense correction then the output of a 12V semi-regulated supply could vary by up to 2V !!

Great care and consideration needs to be paid to ensure that these effects (and possibly others) will

not cause any problems. It is also useful to know if the power supply you are considering using has semi-reg outputs as this is often not shown in product datasheets (although by checking the [Cross Regulation](#), [Load Regulation](#) or [Total Regulation](#) specification, it should be possible to deduce this).

Sense – The connection which allows the power supply control loop to see the voltage present at the load.

See also [Remote Sensing](#).

Sense +ve – See [Sense](#).

Sense -ve – See [Sense Return](#).

Sense Line – See [Sense](#).

Sense Line Return – See [Sense Return](#).

Sense Return – The return connection which allows the control loop to see the voltage present at the load.

See also [Remote Sensing](#).

Sequencing – Forcing the order of turn on (and/or occasionally off) of individual outputs of a [Multiple Output Power Supply](#) (PSU).

Series – Connecting two or more power supplies (+ve of PSU 1 to -ve of PSU 2 and so on) to increase the output voltage (which will simply be the sum of all output voltages). This is only possible with isolated outputs and particular care needs to be paid to short circuit currents. It is better to only series connect outputs which have the same or similar output currents. The maximum output current will be the lowest of each of the series connected power supplies. For example. Connecting a 24V / 10A power supply in series with a 12V / 20A power supply will provide 36V / 10A (the sum of 24V and 12V for the output voltage and the lowest of 20A and 10A for the output current). Care needs to be taken when connecting outputs in series to ensure that the output isolation to ground is not exceeded.

Series Regulator – See [Linear Regulation](#).

Setting Accuracy – The accuracy to which the outputs of a power supply are set. For example, if a 12V power supply has a setting accuracy of 1% then the output voltage range could be 11.88 – 12.12 V.

Setting Range – The range over which the value of the stabilised output quantity may be adjusted. Usually applies to output voltage. See also [Adjustment Range](#).

Settling Time – The time for a power supply (PSU) to stabilise within specifications after an excursion outside the input/output design parameters.

Shelf Life – The time it is possible to store a power supply under specified conditions and still retain the ability to operate to specification.

Shock Hazard – A potentially dangerous situation in which current can pass through a person or animal.

Short-Circuit – A direct connection that provides a virtually zero resistance path for current.

Short-Circuit Current (SCC) – The initial value of the current obtained from a power supply in a circuit of negligible resistance.

Short-Circuit Protection – A protective feature that limits the output current of a power supply (PSU) to prevent damage to the power supply. Care must be taken to ensure that connecting leads and any PCB tracks are designed to allow for the maximum current possible from the power supply (or supply additional protection circuitry / fusing for protection).

Short-Circuit Test – shorting the output to ensure that the short circuit current is within its specified limits.

Shunt Regulator – A linear regulator in which the control element (usually a [Zener Diode](#)) is in parallel with the load, and in series with an impedance, to achieve constant voltage across the load.

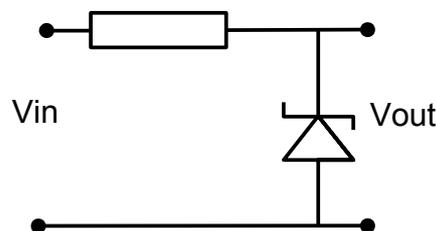

Drawing 30: Schematic of Simple Shunt Regulator

Siemens (S) – [SI](#) unit of measurement of conductance (replaces older [cgs](#) unit, mho). Written as 'siemens'. Abbreviated to **S**.

Signal Ground – The common return or reference point for analogue signals.

Silicon Carbide Schottky Diodes - SiC Schottky diodes have essentially no reverse recovery current, and the minimal amount of capacitive current present in turn-off is independent from temperature, forward current, and di/dt. This results in virtually no switching losses for the rectifier and substantially lessens switching losses in the switch. The use of silicon carbide diodes in the pfc circuit (as in TDK-Lambda's NV-Power range of power supplies) can offer around 4% efficiency improvement.

Silicon-Controlled Rectifier (SCR) – A four layer (PNPN) junction device which controls current flow. Conduction is initiated by the application of a gate current. Conduction will continue until the current is reduced to some minimum value.

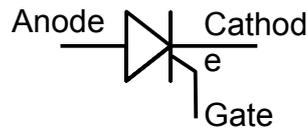

Drawing 31: Schematic Symbol for an SCR

- Sine Wave** – A wave form of a single frequency alternating current whose displacement is the sine of an angle proportional to time or distance.
- Single Point Ground** – The one point in a system that connects multiple grounds and returns. Also known as star ground or star point ground.
- Sixteenth Brick** - - Industry standard footprint for dc-dc converters. Dimensions are 33mm x 22.9mm (1.3in x 0.9in). See also [Full Brick](#), [Half Brick](#), [Quarter Brick](#), [Eighth Brick](#). TDK-Lambda's iSA range of dc/dc converters are industry leading examples of sixteenth bricks.
- Slave** – A power supply (PSU) which uses the reference in another power supply (PSU), the master, as its reference. See [Master Slave Operation](#).
- Slewing Rate** – The maximum rate of change a power supply (PSU) output can produce when subjected to a large step response or specified step change.
- Snubber / Snubber Network** – A network used to reduce the rate of rise of voltage and hence overshoot voltage in switching applications.
- Soft Start** – Controlled turn on to reduce [Inrush Current](#).
- Soldering** – Joining metal surfaces by fusion of a metal alloy such as tin, silver and copper (SnAgCu). It forms a joint of low [Resistance](#). Previously, solders with a high lead content were commonplace but have since been largely replaced by lead-free solders (to comply with the [RoHS Directive](#))
- Solid-state** – Originally meaning circuits which do not contain vacuum tubes (valves) but has come increasingly to mean circuits with no moving parts.
- Solid-state Switch** – A switch with no moving parts.
- Source Impedance** – See [Internal Impedance](#)
- Spacings** – See [Clearance Distance](#), [Creepage Distance](#).
- Stability** – The amount of change in an output parameter (with all other factors constant) as a function of time after a specified warm-up period.
- Standard Wire Gauge** – A standard for sizing wire diameters and for measuring sheet-metal thicknesses. Note that SWG is used mainly in the UK and is different from the thicknesses/diameters associated with [AWG](#) numbers. See [Useful Conversion Factors](#). Also called Imperial Standard Wire Gauge.
- Stand-off** – A mechanical support, either conducting or insulating, used to support a wire, device or PCB away from the mounting surface.
- Star Ground** – See [Single Point Ground](#).
- Star Point Ground** – See [Single Point Ground](#).
- Start-Up Delay** – See [Start-Up Time](#).
- Start-Up Time** – The time delay between applying ac (or a remote “on”) and the time at which the outputs are within specification.
- Status Signals** – Logic signals that indicate normal or abnormal conditions of operation, including:-
- | | | |
|-----------------|-------------------|------------------|
| ac low | dc low | ac good / ac ok |
| dc good / dc ok | fan fail | over temperature |
| overvoltage | under temperature | overcurrent. |
- Step-Down Transformer** – A transformer with an input/output [turns ratio](#) more than one. The output voltage is less than the input voltage. See also, [Isolation Transformer](#), [Step-up Transformer](#), [Transformer](#).
- Step-Up Transformer** – A transformer with an input/output [turns ratio](#) less than one. The output voltage is more than the input voltage. See also, [Isolation Transformer](#), [Step-Down Transformer](#), [Transformer](#).
- Storage Life** – See [Shelf Life](#).
- Storage Temperature Range** – The range of temperatures through which an unpowered power supply (PSU) can remain in storage without degrading its operation. See also [Ambient Temperature](#), [Operating Temperature Range](#).
- Supplementary Insulation** – An independent Insulation provided in addition to the basic insulation to protect against electric shock in case of mechanical rupture or electrical breakdown of the basic insulation. Used together with [Basic Insulation](#) provides [Double Insulation](#).

Surface Mount Device (SMD) – A type of component which is intended to be mounted directly upon the surface of a printed circuit board.

Switched Mode Power Supply (SMPS) - A device which supplies electrical energy to a load using switching technology. SMPS are used as replacements for linear supplies when higher efficiency, smaller size or lighter weight are required.

There are many types of different power supplies including [Linear Supplies](#), [Switched Mode Power Supplies](#), [DC-DC converters](#), [Programmable Power Supplies](#) . TDK-Lambda is able to supply many different types of power supplies to meet your requirements from only a few watts up to 60kwatts.

Switching Frequency – The rate at which the dc voltage is switched in a converter or power supply (PSU). In [power factor corrected](#) PSUs, there will be two switching frequencies, the boost converter switching frequency and the forward converter switching frequency. Additionally, some power supplies may have additional converters with their own switching frequencies (for example buck regulators).

Switching Regulator – A voltage regulator which operates by rapidly switching the current into the load to stabilise the output voltage. They are inherently more efficient (up to 90% and above), smaller and lighter than linear regulators but are more complicated. See [Linear Regulation](#).

Synchronous Rectification – A rectification scheme in a switched mode power supply (PSU) in which a FET or bipolar transistor is substituted for the rectifier diode to improve efficiency.

System International d’Unites (SI) – The International System of Units comprise of Base Units and Derived Units. <http://www.bipm.fr/en/si/>.

T

t – Abbreviation for temperature (in °C).

TTL – Abbreviation for transistor-transistor logic.

TUV – Abbreviation for [Technischer Überwachungs-Verein](#)

Tank Circuit – [Parallel resonant circuit](#).

TE – Unit of width (usually) in a 19 inch rack. 1 TE = 1 HP = 0.2 inches = 5.08mm. See [Useful Conversion Factors](#).

Technischer Überwachungs-Verein (TUV) – Laboratories licensed by the German government for testing electronic products to DIN, IEC and VDE standards. <http://www.tuv-uk.com/>

Temperature Coefficient – The average percent change in output parameter (usually voltage) per degree Centigrade change in ambient temperature over a specified temperature range. (Expressed as %/°C). See also [Ambient Temperature](#).

Temperature Derating – The amount by which power supply or component ratings are decreased to permit operating at elevated temperatures.

Temperature Effect – See [Temperature Coefficient](#).

Temperature Range, Operating – See [Operating Temperature Range](#).

Temperature Range, Storage – See [Storage Temperature Range](#).

Tera – SI prefix multiplier. Multiplies by 10^{12} . So 1 THz = 1×10^{12} Hz. Written as 'tera'. Abbreviated to 'T'.

Thermal Protection – Shuts down a power supply (PSU) if its internal temperature (or the temperature of specific components) exceeds a predetermined limit.

Thermal Runaway – A condition in a component where increasing temperature results in increasing losses bringing about a further temperature increase and so on. If left unprotected, this leads to failure.

Thermistor – A device which changes resistance with temperature. In power supplies, negative temperature coefficient thermistors frequently are used as inrush current limiting devices.



Drawing 32: Schematic Symbol for a Thermistor

Three-Phase Electricity – Combination of three alternating currents having their voltages displaced by 120° , or $1/3$ cycle. It is used for the distribution of high power electricity (all national electricity distribution networks distribute 3 phase electricity) and is particularly suited to high power loads.

Most electricity is generated and distributed as three-phase ac. These phases are normally called line 1 (L_1), line 2 (L_2) and line 3 (L_3) or red (R), yellow (Y) and blue (B). In the USA, they are called A-phase, B-phase and C-phase. Power supplies must be specifically designed for 3-phase use.

Three Terminal Regulator – A voltage regulator in a standard 3 terminal transistor package.

Through Plated Hole – see [Plated Through Hole](#).

Thyristor - A solid state device that has bistable electrical characteristics. Three common thyristor devices are diacs, [Silicon-Controlled Rectifiers \(SCR\)](#) and [triacs](#).

Tolerance - Measured or specified percentage variation from nominal.

Top Hat Rail – See [DIN Rail](#).

Topology – The arrangement of energy storage devices (inductors and capacitors) and power handling electronic switches and rectifiers which gives a switch mode power supply its operational capabilities. There are many topologies including Buck, Boost, Flyback, Sepic, 2-switch flyback, forward, 2-switch forward, active clamp forward, half-bridge, push pull, full bridge, phase shifted full bridge, soft switching 2-switch forward, resonant half bridge (modified LLC) (a patented topology used on TDK-Lambda's NV and EFE product ranges), etc. The correct topology to use is determined by the requirements of the power supply.

Toroid – A round magnetic core with a hole in the middle.

Total Regulation – The range of combined regulation tolerances such as the effects of input voltage variation, output load variation, temperature variation, drift and other specified variables. It is expressed as a plus/minus percent from nominal. Also called accuracy limit.

Tracking – A characteristic of a multiple-output power supply (PSU) that describes the changes in the voltage of one output with respect to changes in the voltage or load of another.

Tracking Over Voltage Protection (OVP) – A safety feature for power supplies with adjustable outputs where the trigger point of the OVP tracks with the voltage setting of the output such that a slow change

in the output voltage will adjust the OVP setting but a fast change above the OVP point will trigger the OVP.

Transformer – Device which transfers energy from one circuit to another by electromagnetic induction. See [Isolation Transformer](#), [Step-Down Transformer](#), [Step-Up Transformer](#).

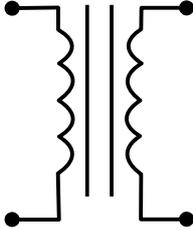

Drawing 33: Schematic Symbol for a Transformer

Transient – A change in a given parameter, typically associated with input voltage or output loading.

Transient Effect – A short term effect on the steady state condition of a circuit.

Transient Recovery Time – The time required for the output voltage of a power supply (PSU) to settle within specified output accuracy limits following a transient. See [Overshoot](#) for drawing.

Transient Response – Response of a circuit to a sudden change in an input or output quantity. See [Overshoot](#) for drawing.

Transient Response Time – The time between introducing a transient (such as additional load) is introduced and the time the measured parameter (such as output voltage) returns and remains within a specified amplitude range. See [Overshoot](#) for drawing.

Transistor – Solid state device which allows the current flow between two of its terminals depending on a smaller current (or voltage) applied to the third terminal. There are two main types of transistors, [bipolar junction transistors](#) and [Field Effect Transistors](#).

Triac – A bi-directional silicon-controlled switch. It will conduct in both directions (from MT1 to MT2 or vice versa). See [Silicon-Controlled Rectifiers \(SCR\)](#).

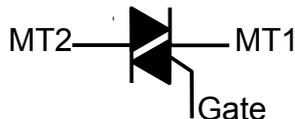

Drawing 34: Schematic Symbol for a Triac

Trifilar – Three conductors wound side by side on a magnetic core or bobbin in which all three conductors are wound in the same operation.

True Power – Actual power generated or consumed in a circuit.

Tuned Circuit – Circuit containing capacitance, inductance and (optionally) resistance, connected in series or parallel, which when energised at a specific frequency known as its resonant frequency, an interchange of energy occurs between the coil and the capacitor.

Turns Ratio – The number of turns on the [transformer primary winding](#) divided by the number of turns on the [secondary winding](#). A [Step-Down Transformer](#) has a turns ratio more than one while a [Step-up Transformer](#) has a turns ratio of less than one. Usually explicitly specified as input/output turns ratio.

U

- U** – Unit of height (usually) in a 19 inch rack. 1 U = 1.75 inch = 44.45mm. See [Useful Conversion Factors](#).
- UL** – Abbreviation for [Underwriters Laboratories Incorporated](#).
- UPS** – Abbreviation for [Uninterruptible Power Supply](#).
- USB** – Abbreviation for [Universal Serial Bus](#).
- Undershoot** – A transient change in output voltage outside of specified regulation limits. See [Overshoot](#) for a drawing to illustrate undershoot.
- Under voltage Protection** – A circuit that inhibits the power supply (PSU) when the output voltage falls below a specified minimum.
- Underwriters Laboratories Incorporated (UL)** – USA based safety agency. See <http://www.ul.com/>.
- Uninterruptible Power Supply (UPS)** – A type of power supply (PSU) designed to support the load for specified periods when the line varies outside specified limits. Generally, they are powered by ac (with battery operation taking over when the ac supply fails) and supply ac on their output. Most likely to be used to protect telecommunications equipment and computer systems.
- Universal Serial Bus (USB)** – A serial Communications Bus now standard on all new PC's. Suitable for communication between one controller (computer) and one or more pieces of equipment (power supply, etc.) See [Communications Port](#).

V

V – Abbreviation for volt.

VA – Abbreviation for volt-ampere.

Vac – Acronym for **volts** of **alternating current**

Vcc – Voltage Collector Collector. Positive supply voltage of a **Bipolar Junction Transistor**. The doubled suffix indicates that the voltage is common. i.e. it is the supply voltage to one (or more) collectors and not just the voltage at a specific collector.

Vdc – Acronym for **volts** of **direct current**

Vdd – Voltage Drain Drain. Positive supply voltage of a Field Effect Transistor. The doubled suffix indicates that the voltage is common. i.e. it is the supply voltage to one (or more) drains and not just the voltage at a specific drain.

Vee – Voltage Emitter Emitter. Negative supply voltage of a Bipolar Junction Transistor. The doubled suffix indicates that the voltage is common. i.e. it is the supply voltage to one (or more) emitters and not just the voltage at a specific emitter.

Vss – Voltage Source Source. Negative supply voltage of a Field Effect Transistor. The doubled suffix indicates that the voltage is common. i.e. it is the supply voltage to one (or more) sources and not just the voltage at a specific source.

VDE – Abbreviation for **Verband Deutscher Elektrotechniker**.

VDR – Abbreviation for **Voltage Dependent Resistor**.

Variable Resistor – See **Potentiometer**.

Varistor – Combination of **Variable Resistor**. A two-electrode semiconductor device having a non-linear, voltage-dependent resistance (usually a high resistance at low voltages and low resistance at high voltages). Often used to protect circuits against transient voltages.

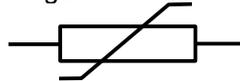

Drawing 35: Schematic Symbol for a Varistor

Varnish Dip – The process of dipping a transformer or coil in varnish to bind or protect materials.

Verband Deutscher Elektrotechniker (VDE) – German organisation charged to test and to evaluate products, including power sources. See http://www.vde.com/vde_en/.

Vias – See **Plated Through Hole**.

Volt (V) – Unit of measurement of electromotive force or potential difference. Symbol E, in electricity; symbol V in semiconductor circuits. A current of 1 A passing through a resistance of 1 ohm will produce a potential difference of 1 volt. See **Ohm's Law**. Written as 'volt'. Abbreviated to **V**.

Volt-Ampere (VA) – Unit of **Apparent Power**.

Volt Microsecond / Volts per Microsecond – Rate of change of voltage over a period of time expressed in volts/microseconds.

Volt Second – In a control circuit, the on-time x the voltage applied to the winding is controlled (effectively running the magnetic component at peak magnetic flux density).

Volt Second Clamp – A circuit in the control of the pulse width modulator located in the primary which terminates the pulse when the volt seconds applied to the primary of the transformer exceeds a predetermined value.

Voltage – A derivative electrical quantity, E, measured in the units volts and defined in terms of the independently obtained ampere, I, and the unit or Resistance, ohm (R) by Ohm's Law $E=IR$.

Voltage Balance – The difference in magnitude, in percent, between differential tracking output voltages of a power supply (PSU) where the voltages have equal nominal values with opposite polarities.

Voltage Clamp – See **Clamp Circuit**

Voltage Dependent Resistor – Another name for **Varistor**.

Voltage Divider – Tapped or series resistance or impedance across a source voltage to produce a lower output voltage.

Voltage Drop – Difference in potential between two points in a passive component or circuit.

Voltage Limit – Maximum or minimum value in a voltage range.

Voltage Limiting – Bounding circuit used to set specified maximum or minimum voltage levels.

Voltage Regulation – The process of holding voltage constant between selected parameters, the extent of which is expressed as a percent. See also **Regulation**.

Voltage Source – A power source that delivers constant voltage.

Voltage Stabilisation – The use of a circuit or device to hold an output voltage constant within given limits.

W

W – Abbreviation for [watt](#).

WEEE – Abbreviation for [Waste Electrical and Electronic Equipment Directive](#).

Warm-up Drift – The change in output voltage of a power supply from turn on until it reaches thermal equilibrium at specified operating conditions.

Warm-up Time – The time required after a power supply (PSU) is initially turned on before it operates according to specified performance limits.

Waste Electrical and Electronic Equipment Directive (WEEE) – The European Community Directive on waste electrical and electronic equipment which, together with the [RoHS Directive](#), became European Law in February 2003. It sets targets for collection, recycling and recovery for electrical/electronic goods. The law puts the responsibility for these targets on the companies manufacturing electronic equipment. "Users of electrical and electronic equipment from private households should have the possibility of returning WEEE at least free of charge". Also, the manufacturers must use the collected waste in an ecologically friendly manner, either by ecological disposal or by reuse/refurbish. See also [Restriction of Hazardous Substances Directive](#).

Watt (W) – Unit of measurement of [Power](#). Written as 'watt'. Abbreviated to **W**.

Wide Range Input – The ability for a power supply to operate from a wide range of input voltages (110Vac and 230Vac and any voltage in between). A typical specification for wide range input would be 90Vac to 253Vac. Compare with [Auto-Range Input](#).

Winding – A conductor wound onto a magnetic core, e.g., a transformer [Primary Winding](#) or [Secondary Winding](#).

Working Voltage – The highest RMS value of the ac or dc voltage (disregarding transients) that may occur locally across any insulation at rated supply voltage.

X

X – Symbol for [Reactance](#).

X_c – Symbol for Capacitive Reactance.

X_L – Symbol for Inductive Reactance.

X Capacitors – EMI filter capacitors across the line that meet the requirements of certain regulatory agencies. The class of X capacitor is determined by the equipment standard applicable to the device and the “installation category”, meaning the type of connection to the ac line. These installation categories are defined by IEC664. Installation category II is for connection to ordinary wall outlets and installation category III is for connection to main power trunk lines within a building.

X1 – A classification of [X Capacitors](#). This covers installation category III applications such as for an industrial printer or minicomputer which is connected to a 3-phase line. Industrial lighting ballasts can also fall into this category.

X2 - A classification of [X Capacitors](#). This is the most common as it covers applications using line voltages from 150 to 250VAC (nominal) which are plugged into ordinary wall outlets.

Y

Y Capacitors – EMI filter capacitors between line and ground that meet the requirements of certain regulatory agencies. The class of Y Capacitor required is determined by the insulation grade being bridged and the line voltage used.

Y1 -A type of [Y capacitor](#). For bridging reinforced or double insulation with line voltages up to 250VAC (nominal).

Y2 – A type of [Y capacitor](#), allowed to bridge basic and supplementary insulation with line voltages up to 250VAC (nominal).

Yocto – SI prefix multiplier. Multiplies by 10^{-24} . So $100 \text{ yF} = 100 \times 10^{-24} \text{ F}$. Written as 'yocto'. Abbreviated to 'y'.

Yotta – SI prefix multiplier. Multiplies by 10^{24} . So $100 \text{ YF} = 100 \times 10^{24} \text{ F}$. Written as 'yotta'. Abbreviated to 'Y'.

Z

Z – Symbol for [Impedance](#).

Zener Diode – A diode that permits current to flow both in the forward direction (like a conventional diode) and in reverse direction. When current flows in the reverse direction, Zener diodes are designed to drop a specified amount of voltage (the [Zener Voltage](#)). They are used primarily to regulate the output voltage of low power regulators.

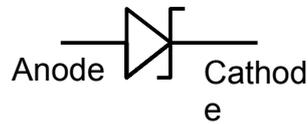

Drawing 36: Schematic Symbol for a Zener Diode

Zener Voltage – The reverse voltage at which breakdown occurs in a [Zener Diode](#).

Zepto – SI prefix multiplier. Multiplies by 10^{-21} . So 100 zF = 100×10^{-21} F. Written as 'zepto'. Abbreviated to 'z'.

Zetta – SI prefix multiplier. Multiplies by 10^{21} . So 100 ZF = 100×10^{21} F. Written as 'zetta'. Abbreviated to 'Z'.

Useful Conversion factors

Prefixes

Prefix	Symbol	Factor
yotta	Y	10 ²⁴
zetta	Z	10 ²¹
exa	E	10 ¹⁸
peta	P	10 ¹⁵
tera	T	10 ¹²
giga	G	10 ⁹
mega	M	10 ⁶
kilo	k	10 ³
hecto	h	10 ²
deca	da	10
deci	d	10 ⁻¹
centi	c	10 ⁻²
milli	m	10 ⁻³
micro	μ	10 ⁻⁶
nano	n	10 ⁻⁹
pico	p	10 ⁻¹²
femto	f	10 ⁻¹⁵
atto	a	10 ⁻¹⁸
zepto	z	10 ⁻²¹
yocto	y	10 ⁻²⁴

Table 1: Prefixes

For example:-

$$1 \mu\text{F} = 1 \times 10^{-6} \text{ F} \quad (0.000001 \text{ F})$$

Lengths

$$1 \text{ U} = 1.75 \text{ inch} = 44.45\text{mm} \quad (\text{usually used in 19 inch rack equipment})$$

$$1 \text{ TE} = 1 \text{ HP} = 0.2 \text{ inch} = 5.08\text{mm} \quad (\text{usually used in 19 inch equipment})$$

a 19 inch rack usually holds 84 HP / TE (making 16.8 inches usable)

$$1 \text{ inch} = 2.54\text{cm}$$

$$1 \text{ foot} = 12 \text{ inches} = 30.48\text{cm}$$

$$1 \text{ metre} = 39.37 \text{ inches} = 3.28 \text{ feet}$$

Temperature

To convert degrees Celsius (or degrees Centigrade) - °C - to degrees Fahrenheit (°F):-

$$\text{Temp}(\text{°F}) = \text{Temp}(\text{°C}) \times 1.8 + 32$$

Example:

Convert 50°C to degrees Fahrenheit

$$\text{Temp}(\text{°F}) = 50 \times 1.8 + 32 = 122 \text{ °F}$$

To convert degrees Fahrenheit (°F) to degrees Celsius (or Centigrade) (°C)

$$Temp(^{\circ}C) = \frac{Temp(^{\circ}F) - 32}{1.8}$$

Example:

Convert 122°F to °C

$$Temp(^{\circ}C) = \frac{(122 - 32)}{1.8} = 50^{\circ}C$$

To convert **kelvin** to degrees Celsius (or degrees Centigrade)

$$Temp(^{\circ}C) = Temp(K) - 273.15$$

Example:

Convert 323.15 K to °C

$$Temp(^{\circ}C) = 323.15 - 273.15 = 50^{\circ}C$$

To convert degrees Celsius (or degrees Centigrade) to **kelvin**

$$Temp(K) = Temp(^{\circ}C) + 273.15$$

Example:

Convert 100°C to kelvin

$$Temp(K) = 100 + 273.15 = 373.15$$

Weights

1 Pound (lb) = 16 ounces (oz) = 0.4536 kg

1 ounce (oz) = 28.349 gram = 0.028349 kg

1kg = 2.2046 lb

1kg = 1000 gram = 35.274 ounces (oz)

Airflow

1m/s = 3.28 feet per second = 196.85 LFM (linear feet per minute)

1 LFM = 0.0167 feet per second = 0.00508 m/s

LFM	m/s
50	0.25
98	0.5
197	1
295	1.5
394	2
591	3
787	4
984	5

Table 2: LFM to m/s conversion

To convert CFM (cubic feet per minute) to LFM (linear feet per minute)

$$Velocity_{(LFM)} = \frac{Volume_{(CFM)}}{area_{(ft^2)}}$$

For example:-

Width = 3.3in = 0.275 ft

Height = 1.5in = 0.125 ft

area = 4.95 in² = 0.034375 ft²

Airspeed = 30 CFM

Velocity (LFM) = 30 / 0.034375 = 872 LFM

Convert this to m/s = 872 / 196.85 = 4.43 m/s

To convert CFM and dimensions in inches to m/s directly

$$Velocity_{(m/s)} = \frac{Volume_{(CFM)}}{(width_{(inches)} \times height_{(inches)} \times 1.367014)}$$

For example:- Airflow needed = 30 CFM into a Power supply which is 3.3in wide x 1.5in tall

$$Velocity_{(m/s)} = \frac{30CFM}{(3.3in \times 1.5in \times 1.367014)}$$

$$Velocity_{(m/s)} = 4.43 m/s$$

To convert CFM and dimensions in mm to m/s directly

$$Velocity_{(m/s)} = \frac{471.9484 \times Volume_{(CFM)}}{(width_{(mm)} \times height_{(mm)})}$$

For example:- Airflow needed = 12 CFM into a Power supply which is 94mm wide x 33mm tall

$$Velocity_{(m/s)} = \frac{471.9484 \times 12CFM}{(94mm \times 33mm)}$$

$$Velocity_{(m/s)} = 1.83 m/s$$

To convert m/s and dimensions in inches to CFM directly

$$Airflow_{(CFM)} = Airspeed_{(m/s)} \times (width_{(inches)} \times height_{(inches)} \times 1.367014)$$

For example:- Airflow needed = 2 m/s into a Power supply which is 3in wide x 1.3in tall

$$Airflow_{(CFM)} = 2 m/s \times 3in \times 1.3in \times 1.367014$$

$$Airflow_{(CFM)} = 9.84 CFM$$

To convert CFM and dimensions in mm to m/s directly

$$Airflow_{(CFM)} = \frac{Airspeed_{(m/s)} \times width_{(mm)} \times height_{(mm)}}{471.9484}$$

For example:- Airflow needed = 2 m/s into a Power supply which is 76mm wide x 33mm tall

$$Airflow_{(CFM)} = \frac{2m/s \times 76mm \times 33mm}{471.9484}$$

$$Airflow_{(CFM)} = 10.63CFM$$

Energy

To convert joules (J) to electron volt (eV)

$$Energy(eV) = Energy(Joules) \times 6.2415 \times 10^{18}$$

To convert electron volts (eV) to joules (J)

$$Energy(J) = \frac{(Energy(eV))}{(6.2415 \times 10^{18})}$$

To convert kilowatt-hour to joules

$$Energy(J) = Energy(kWh) \times 3.60 \times 10^6$$

To convert joules to kilowatt-hour

$$Energy(kWh) = \frac{Energy(J)}{(3.60 \times 10^6)}$$

Cable Size

To convert AWG to Inches

The diameter of a Number n AWG wire in inches is given by

$$d_n = 0.005 \times 92^{\left(\frac{36-n}{39}\right)}$$

For example, 36AWG

$$d_n = 0.005 \times 92^{\left(\frac{36-36}{39}\right)}$$

$$d_n = 0.005 \times 92^0$$

$$d_n = 0.005 \times 1$$

$$d_n = 0.005 \text{ inches}$$

Wire Gauge	American Wire Gauge (AWG)	Imperial Standard Wire Gauge (SWG)
0000000	0.651 (16.5mm)	0.500 (12.7mm)
000000	0.580 (14.7mm)	0.464 (11.8mm)
00000	0.517 (13.1mm)	0.432 (11.0mm)
0000	0.460 (11.7mm)	0.400 (10.2mm)
000	0.410 (10.4mm)	0.372 (9.45mm)
00	0.365 (9.27mm)	0.348 (8.84mm)
0	0.325 (8.25mm)	0.324 (8.23mm)
1	0.289 (7.35mm)	0.300 (7.62mm)
2	0.258 (6.54mm)	0.276 (7.01mm)
3	0.229 (5.83mm)	0.252 (6.40mm)
4	0.204 (5.19mm)	0.232 (5.89mm)
5	0.182 (4.62mm)	0.212 (5.38mm)
6	0.162 (4.12mm)	0.192 (4.88mm)
7	0.144 (3.66mm)	0.176 (4.47mm)
8	0.128 (3.26mm)	0.160 (4.06mm)
9	0.114 (2.91mm)	0.144 (3.66mm)
10	0.102 (2.59mm)	0.128 (3.25mm)
11	0.0907 (2.30mm)	0.116 (2.95mm)
12	0.0808 (2.05mm)	0.104 (2.64mm)
13	0.0720 (1.83mm)	0.0920 (2.34mm)
14	0.0641 (1.63mm)	0.0800 (2.03mm)
15	0.0571 (1.45mm)	0.0720 (1.83mm)
16	0.0508 (1.29mm)	0.0640 (1.63mm)
17	0.0453 (1.15mm)	0.0560 (1.42mm)
18	0.0403 (1.02mm)	0.0480 (1.22mm)
19	0.0359 (0.912mm)	0.0400 (1.02mm)
20	0.0320 (0.812mm)	0.0360 (0.914mm)
21	0.0285 (0.723mm)	0.0320 (0.813mm)
22	0.0253 (0.644mm)	0.0280 (0.711mm)

Wire Gauge	American Wire Gauge (AWG)	Imperial Standard Wire Gauge (SWG)
23	0.0226 (0.573mm)	0.0240 (0.610mm)
24	0.0201 (0.511mm)	0.0220 (0.559mm)
25	0.0179 (0.455mm)	0.0200 (0.508mm)
26	0.0159 (0.405mm)	0.0180 (0.457mm)
27	0.0142 (0.361mm)	0.0164 (0.417mm)
28	0.0126 (0.321mm)	0.0148 (0.376mm)
29	0.0113 (0.286mm)	0.0136 (0.345mm)
30	0.0100 (0.255mm)	0.0124 (0.315mm)
31	0.00893 (0.227mm)	0.0116 (0.295mm)
32	0.00795 (0.202mm)	0.0108 (0.274mm)
33	0.00708 (0.180mm)	0.010 (0.254mm)
34	0.00630 (0.160mm)	0.0092 (0.234mm)
35	0.00561 (0.143mm)	0.0084 (0.213mm)
36	0.00500 (0.127mm)	0.0076 (0.193mm)
37	0.00445 (0.113mm)	0.0068 (0.173mm)
38	0.00397 (0.101mm)	0.0060 (0.152mm)
39	0.00353 (0.0897mm)	0.0052 (0.132mm)
40	0.00314 (0.0799mm)	0.0048 (0.122mm)
41	0.00280 (0.0711mm)	0.0044 (0.112mm)
42	0.00249 (0.0633mm)	0.0040 (0.102mm)
43	0.00222 (0.0564mm)	0.0036 (0.0914mm)
44	0.00198 (0.0502mm)	0.0032 (0.0813mm)
45	0.00176 (0.0447mm)	0.0028 (0.0711mm)
46	0.00157 (0.0398mm)	0.0024 (0.0610mm)
47	0.00140 (0.0355mm)	0.0020 (0.0508mm)
48	0.00124 (0.0316mm)	0.0016 (0.0406mm)
49	0.00111 (0.0281mm)	0.0012 (0.0305mm)
50	0.000986 (0.0251mm)	0.0010 (0.0254mm)

Table 3: Wire Gauge to Wire Diameter – inches (mm in brackets)

Useful Calculations

Resistance and Ohm's Law

$$V = I R$$

V = voltage across the component

I = current through a component

R = Resistance of the component

Series connection (of n resistors)

$$R_{tot} = R_1 + R_2 + \dots + R_n$$

Parallel connection (of n resistors)

$$\frac{1}{R_{tot}} = \frac{1}{R_1} + \frac{1}{R_2} + \dots + \frac{1}{R_n}$$

For two resistors in parallel:-

$$R_{tot} = \frac{(R_1 R_2)}{(R_1 + R_2)}$$

For N equal resistors in parallel, each of resistance R:-

$$R_{tot} = \frac{R}{N}$$

Reactance

$$Z = R + jX$$

Where:-

Z is impedance measured in [ohms \(\$\Omega\$ \)](#)

R is resistance measured in [ohms \(\$\Omega\$ \)](#)

X is reactance measured in [ohms \(\$\Omega\$ \)](#)

j is the imaginary part $j = \sqrt{-1}$

If only the magnitude of the impedance is required then:-

$$|Z| = \sqrt{(R^2 + X^2)}$$

Voltage Divider Rule:

$$V_{out} = V_{ip} \left(\frac{R_2}{(R_1 + R_2)} \right)$$

Electrical Energy and Power

$$P = I V$$

For an ac circuit,

$$P_{av} = I_{rms}^2 R = \frac{V_{rms}^2}{R} \quad (\text{average power dissipated in resistor})$$

I_{rms} = rms current through the resistor

V_{rms} = rms voltage across the resistor

If the load is a resistor (i.e., it obeys Ohm's law) then:-

$$P = I^2 R = \frac{V^2}{R}$$

P = Power supplied by a source or delivered to a load

I = current through a load/supplied from source

R = Resistance of the load

V = Voltage across load / source

Capacitors

$$Q = C V$$

Q = Charge in capacitor (in coulombs)

C = Capacitance (in farads)

V = Potential difference across capacitor (in volts)

$$Q = I T$$

Parallel connection (of n capacitors):

$$C_{total} = C_1 + C_2 + \dots + C_n$$

Series connection (of n capacitors):

$$\frac{1}{C_{total}} = \frac{1}{C_1} + \frac{1}{C_2} + \dots + \frac{1}{C_n}$$

For two capacitors in series:-

$$C_{tot} = \frac{(C_1 C_2)}{(C_1 + C_2)}$$

For N equal capacitors in series, each of capacitance C:- $C_{tot} = \frac{C}{N}$

Energy stored in a capacitor:-

$$U = \frac{1}{2} C V^2 = \frac{Q^2}{2C} = \frac{1}{2} Q V$$

U = energy (in joules)

C = capacitance (in farads)

V = Potential difference (in volts)

Q = Charge in capacitor (in coulombs)

Capacitors in ac circuits

$$X_c = \frac{1}{\omega C} = \frac{1}{2\pi f C}$$

X = capacitive reactance of capacitor C at frequency f.

$$V_{max} = I_{max} X_c \quad (\text{this is the ac form of Ohm's law. Also, } V_{rms} = I_{rms} X_c)$$

RC Circuits

Impedance (Z)

$$Z = \sqrt{R^2 + X_c^2} = \sqrt{R^2 + \left(\frac{1}{\omega C}\right)^2} = \sqrt{R^2 + \left(\frac{1}{2\pi f C}\right)^2}$$

$$V_{max} = I_{max} Z \quad (\text{this is the ac form of Ohm's law. Also, } V_{rms} = I_{rms} Z)$$

Phase angle by which voltage lags current

$$\theta = \tan^{-1}\left(\frac{X_c}{R}\right)$$

Average Power dissipated in RC circuits (P_{av})

$$P_{av} = I_{rms} V_{rms} \cos \theta$$

Inductors

Energy stored in an inductor $U = \frac{1}{2} L I^2$

U = energy stored (in joules)

L = inductance (in henrys)

I = current through inductor (in amps)

Impedance (inductive reactance) of inductive circuit

$$X_L = \omega L = 2\pi fL$$

RL Circuits

Impedance (Z)

$$Z = \sqrt{R^2 + X_L^2} = \sqrt{R^2 + (\omega L)^2} = \sqrt{R^2 + (2\pi fL)^2}$$

$$V_{max} = I_{max} Z \quad (\text{this is the ac form of Ohm's law. Also, } V_{rms} = I_{rms} Z)$$

Phase angle by which voltage leads current

$$\theta = \tan^{-1}\left(\frac{X_L}{R}\right)$$

Average Power dissipated in RL circuits (P_{av})

$$P_{av} = I_{rms} V_{rms} \cos \theta$$

RLC Circuits (Series Resonant)

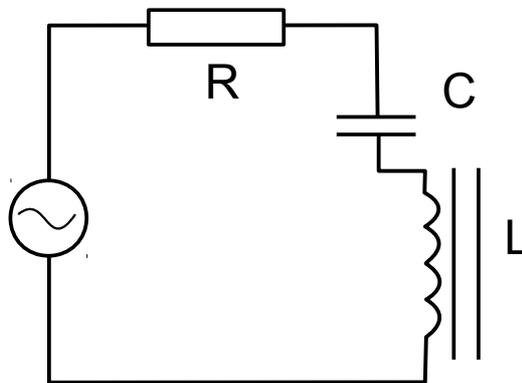

Drawing 37: Series Resonant Circuit

Impedance (Z)

$$Z = \sqrt{R^2 + (X_L - X_C)^2} = \sqrt{R^2 + \left(\omega L - \frac{1}{\omega C}\right)^2} = \sqrt{R^2 + \left(2\pi fL - \frac{1}{2\pi fC}\right)^2}$$

At the resonant frequency, $Z = R$

$$V_{max} = I_{max} Z \quad (\text{this is the ac form of Ohm's law. Also, } V_{rms} = I_{rms} Z)$$

Phase angle by which voltage leads current

$$\theta = \tan^{-1}\left(\frac{(X_L - X_C)}{R}\right) = \tan^{-1}\left(\frac{(\omega L - \frac{1}{\omega C})}{R}\right)$$

Average Power dissipated in RLC circuits (P_{av})

$$P_{av} = I_{rms} V_{rms} \cos \theta$$

Resonant (angular) frequency

$$\omega = \frac{1}{\sqrt{LC}}$$

Resonant frequency

$$f = \frac{1}{(2\pi\sqrt{LC})}$$

RLC Circuits (Parallel Resonant)

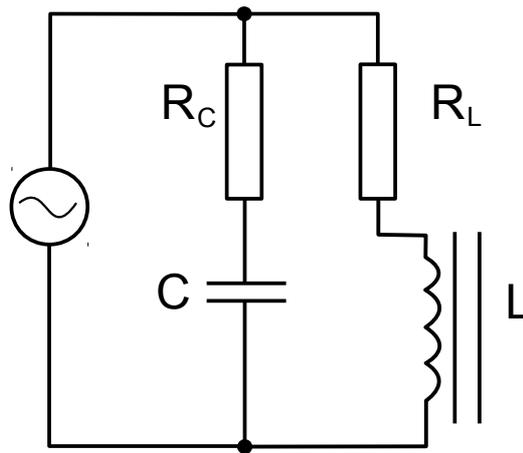

Drawing 38: Parallel Resonant Circuit

Resonant (angular) frequency

$$\omega_0 = \frac{1}{\sqrt{LC}} \left[\frac{(R_L^2 C - L)}{(R_C^2 C - L)} \right]^{1/2}$$

Installation for optimum EMC performance

Mounting

All equipment should be mounted inside an earthed metal box.

If this is not possible then use an earthed metal plane to mount the power supply (PSU) and load.

Cables

All cables (both ac input and dc output) should be run as close as possible to the earthed metal box/plane. AC input cable should be a twisted group laid as flat to the earthed metal box/plane as possible.

All power supply (PSU) output cables should be routed as far away from input cables as possible.

If the input and output cables must be run close to each other then screen one or other (or ideally both).

The positive and negative power supply (PSU) output cables should be twisted together.

The remote sense wires (if used) should be twisted together and run alongside their related power supply (PSU) output cables.

All cable run loops should be kept as small as possible (this should be implemented in PCB design also).

Connecting between boxes

If cables must be connected between equipment boxes then at the closest possible point to the port where the cables exit the 1st enclosure connect 100nF decoupling Y caps (between the output and earth). Note that these capacitors must be rated at the working voltage. Ideally these capacitors should be between all signal cables which have to connect between boxes although this may not be practical if fast switching [digital] signals are involved (if this is the case then smaller value Y capacitors should be used).

Earth star point

If the power supply (PSU) is supplied without an IEC inlet then where the ac supply enters the equipment, this should be taken to a 'star point' chassis mounted earth point as close as possible to the ac inlet. All other earth points should be taken back to this point only.

If the power supply (PSU) is supplied fitted with an IEC inlet then a 'star point' should be created as near as possible to the mounting screw closest to the inlet side of the power supply (PSU).

(Note compliance with EN60950 practices which require own star point washer and nut).

External Fusing

Criteria for externally fitted fuses in the input lines of a TDK-Lambda power supply.

Normally the internal fuse fitted in the power supply is rated approximately 20 - 25% greater than the maximum I/P current at low line and maximum load to overcome nuisance blowing.

The addition of external fusing is usually for one of the following reasons:

1. The supply is to be used in a medical application and therefore must have dual fusing.
2. To allow the customer to change fuses in the event of a problem because the unit fuse is NOT accessible.

WARNING: If the fuse blows immediately after being replaced the Power Supply must be viewed as having a serious malfunction and must be returned to TDK-Lambda.

3. The Power Supply is to be connected to a non-polarised mains supply (where it is not certain which line is live).

It is important therefore, to consider the following when selecting fuses to be fitted externally to the Power Supply:

Any external fuse:

1. Should not be rated higher than the fuse fitted inside the power supply (the internal fuse rating is stated in the installation manual).
2. Should be a minimum of one rating below the fuse fitted in the Power Supply (see note ¹)
3. Should have at least the same speed of response as the fuse fitted inside the power supply. e.g. FAST or SLOW acting.
4. Should have [High Breaking Capacity](#).

¹ Fuse selection may be made from the same series of fuse fitted in the Power Supply (see installation guide) provided that the fuse chosen is greater than the Power Supplies maximum I/P current at low line and maximum load. Selecting a fuse with a lower rating may result in nuisance blowing.

Safety Approvals

Laboratory and Measurement Equipment

IEC61010-1
EN61010-1

Medical

IEC60601-1
EN60601-1

ITE and Telecoms

IEC60950-1
EN60950-1

LVD

EN60950-1
EN61010-1

North America

UL/CSA 60950-1
UL/CSA 61010-1
UL/CSA 60601-1

TDK-Lambda Company Contacts

AUSTRIA

TDK-Lambda Austria Sales Office
Aredstraße 22
2544 Leobersdorf

Telephone: +43 (0) 2256 655 84
Facsimile: +43 (0) 2256 645 12
Web: <http://www.emea.lambda.tdk.com/de>

FRANCE

TDK-Lambda France SAS
ZAC des Delaches, BP1077 - Gometz le Chatel
91940 Les Ulis

Telephone: +33 (0) 1 60 12 71 65
Facsimile: +33 (0) 1 60 12 71 66
Web: <http://www.emea.lambda.tdk.com/fr>

GERMANY

TDK-Lambda Germany GmbH
Karl-Bold-Straße 40
D-77855 Achern

Telephone: +49 (0) 78 41 666 0
Facsimile: +49 (0) 78 41 5000
Web: <http://www.emea.lambda.tdk.com/de>

ISRAEL

TDK-Lambda Ltd
Kibbutz Givat
Hashlosha 48800

Telephone: +972 (0) 3 902 4333
Facsimile: +972 (0) 3 902 4777
Web: <http://www.emea.lambda.tdk.com/il>

ITALY

TDK-Lambda France sas Succursale Italiana
Via Giacomo Matteotti 62,
20092, Cinisello Balsamo (Mi)

Telephone: +39 (0) 02 61 29 38 63
Facsimile: +39 (0) 02 61 29 09 00
Web: <http://www.emea.lambda.tdk.com/it>

UK

TDK-Lambda UK
Kingsley Avenue
Ilfracombe Devon EX34 8ES

Telephone: +44 (0) 1271 856666
Facsimile: +44 (0) 1271 864894
Web: <http://www.emea.lambda.tdk.com/uk>

TDK-LAMBDA NORTH AMERICA

visit <http://www.us.lambda.tdk.com/> for a list of TDK-Lambda offices and distributors.

TDK-Lambda ASIA

visit <http://www.emea.lambda.tdk.com/> for a list of TDK-Lambda offices and distributors.

No responsibility or liability can be accepted by TDK-Lambda for the content of this document which should be taken as our interpretation of the various requirements and definitions contained within. Additionally, note that whilst we have tried to be as accurate with the definitions and conversion factors included within this document, we cannot be held responsible for inaccuracies.