

**Einbau-Digital-Decoder**

**Digital Installation Decoder**

**Décodeur numérique à installer**

**Inbouw-digitaaldecoder**

**Decoder digital integrable**

**Decoder Digital installabile**

**Dekodermontage**

**Digital indbygningsdekoder**

---

**74461**

<b>Inhaltsverzeichnis</b>	<b>Seite</b>	<b>Sommaire</b>	<b>Page</b>
Bestimmungsgemäße Verwendung	4	Usage conforme	12
Lieferumfang	4	Matériel fourni	12
Sicherheitshinweise	4	Consignes de sécurité	12
Wichtige Hinweise	4	Indications importantes	12
Funktionen	4	Fonctions	12
Decoder-Einbau	5	Installation du décodeur	13
Entsorgung	5	Elimination	13
Garantie	5	Garantie	13
CV Programmierung	6	Programmation des CV	14
Programmier-Tabellen	39	Tableau de programmation	39

<b>Table of Contents</b>	<b>Page</b>	<b>Inhoudsopgave</b>	<b>Pagina</b>
Normal Use	8	Beoogd gebruik	16
Contents as Delivered	8	Leveringsomvang	16
Safety Notes	8	Veiligheidsvoorschriften	16
Important Information	8	Belangrijke aanwijzingen	16
Functions	8	Werking	16
Decoder Installation	9	Decoder inbouwen	17
Disposal	9	Afdanken	17
Warranty	9	Garantie	17
CV Programming	10	CV-programmering	18
Programming Table	39	Programmeertabel	39

<b>Índice</b>	<b>Página</b>	<b>Innehållsförteckning</b>	<b>Sidan</b>
Uso previsto	20	Användningsområde	28
Alcance de suministro	20	Ingående material vid leverans	28
Instrucciones de seguridad	20	Säkerhetsanvisningar	28
Notas importantes	20	Viktig information	28
Funciones	20	Funktioner	28
Montaje del decoder	21	Inbyggnad av dekodern	29
Eliminación	21	Hantering som avfall	29
Garantía	21	Garanti	29
Programación de variables CV	22	CV programmering	30
Tabla de programación	39	Programmeringstabell	39

<b>Elenco del contenido</b>	<b>Página</b>	<b>Indholdsfortegnelse</b>	<b>Side</b>
Impiego commisurato alla destinazione	24	Hensigtsmæssig anvendelse	32
Corredo di forniture	24	Leveringsomfang	32
Avvertenze di sicurezza	24	Sikkerhedsbemærkninger	32
Avvertenze importanti	24	Vigtige bemærkninger	32
Funzioni	24	Funktioner	32
Montaggio del Decoder	25	Indbygning af dekoder	33
Smaltimento	25	Bortskaffelse	33
Garanzia	25	Garanti	33
Programmazione delle CV	26	CV programmering	34
Tabella di programmazione	39	Programmeringstabel	39

## Bestimmungsgemäße Verwendung

- Der Einbau-Digital-Decoder ist zum Einbau in Märklin- und Trix-C-Gleis-Weichen mit Weichenantrieb bestimmt (ausgenommen Märklin-Dreiwegweiche).
- Der Einbau-Digital-Decoder darf bei externer Stromversorgung nur an Märklin- bzw. Trix-Schaltnetzteile angeschlossen werden.
- Darf nur in trockenen Räumen verwendet werden.

### Lieferumfang

- 1 Einbau-Digital-Decoder
- 1 Kabel gelb, rot und braun (C-Gleis Märklin)
- 1 Kabel blau, rot und weiß (C-Gleis Trix)
- Einbauanleitung
- Garantieurkunde

Für den Einbau zusätzlich benötigtes Werkzeug: Pinzette und Lötstation für eine Löttemperatur bis max. 30W/300° mit dünner Spitze, Elektronik-Lötzinn (Ø 0,5-1 mm), Entlötlitze oder Entlötsaugpumpe.

## Sicherheitshinweise

- **ACHTUNG!** Funktionsbedingte scharfe Kanten und Spitzen.
- Verkabelungs- und Montagearbeiten nur im spannungslosen Zustand ausführen. Bei Nichtbeachtung kann es zu gefährlichen Körperströmen und damit zu Verletzungen führen.
- **Decoder nur mit der zulässigen Spannung** (siehe technische Daten) **betreiben**.



Beim Umgang mit dem LötKolben besteht die Gefahr von **Hautverbrennungen**.

## Wichtige Hinweise

- **Achtung:** Beim Einbau möglichst keine Bauteile auf der

Oberseite des Einbau-Digital-Decoders berühren, statische Aufladung kann die Funktion beeinträchtigen.

- Die Bedienungsanleitung ist Bestandteil des Produktes und muss deshalb aufbewahrt sowie bei Weitergabe des Produktes mitgegeben werden.
- Für Reparaturen wenden Sie sich bitte an Ihren Märklin-Fachhändler.
- <http://www.maerklin.com/en/imprint.html>

## Technische Daten

- Belastung Laternenausgang ≤ 100 mA
- Belastung Weichenausgang max. 2 A
- Spannung Digitalstromkreis max. 20 V eff.
- Spannung extern max. 20 V DC
- Spannungsfestigkeit max. 40 V

## Funktionen

- Multiprotokoll fähig: fx (MM) und DCC
- Einstellen der Betriebsart mittels DIP-Schalter
- Einstellbare Adressen mit DIP-Schalter:  
**1-256** fx (MM) (Control Unit 6021/Mobile Station 60651/652)  
**1-320** fx (MM) (Central Station 6021x/Mobile Station 60653)  
**1-511** (DCC)
- Programmierbare Adressen über CV  
**1-2.044** DCC
- Änderungen der Eigenschaften über CV
- Digitalsignal: Übertragung unabhängig von der Stromversorgung
- Stromversorgung über Digitalstromkreis
- Alternative Stromversorgung
- Löt pads für Anschluss der Weichenlaterne
- Weichenlaterne aus- oder einschaltbar

## Decoder-Einbau

**Folgende Arbeitsschritte dürfen nur im spannungslosen Zustand ausgeführt werden:**

- Stecken Sie das mitgelieferte Kabel (Gleissystem beachten) in die dafür vorgesehene Buchse, siehe Seite 36/37 (Märklin und Trix). Folgen Sie nun der bebilderten Anleitung.

Änderungen der anderen Eigenschaften im fx (MM)-Protokoll durch CV-Programmierung oder zur DCC CV-Programmierung folgen Sie dem Kapitel „CV Programmierung“.

**Beachten Sie:** Einstellungen mit dem DIP-Schalter immer spannungslos vornehmen. Der Einbau-Digital-Decoder erkennt erst mit dem Einschalten der Spannung die aktuellen Schalterstellungen.

Ab Seite 39 finden Sie die Tabelle für die Adressierung mit DIP-Schalter.

Einbau des Einbau-Digital-Decoders in Märklin-Standard-, Bogen- oder Doppelkreuzungsweiche siehe Seite 36.

Einbau des Einbau-Digital-Decoders in Trix-Standard-, Bogen- oder Doppelkreuzungsweiche siehe Seite 37.

## Entsorgung



Hinweise zum Umweltschutz: Produkte, die mit dem durchgestrichenen Mülleimer gekennzeichnet sind, dürfen am Ende ihrer Lebensdauer nicht über den normalen Haushaltsmüll entsorgt werden, sondern müssen an einem Sammelpunkt für das Recycling von elektrischen und elektronischen Geräten abgegeben werden. Das Symbol auf dem Produkt, der Bedienungsanleitung oder der Verpackung weist darauf hin. Die Werkstoffe sind gemäß ihrer Kennzeichnung wiederverwertbar. Mit der Wiederverwendung, der stofflichen Verwertung oder anderen Formen der Verwertung von Altgeräten leisten Sie einen wichtigen Beitrag zum Schutze unserer Umwelt. Bitte erfragen Sie bei Ihrer Gemeindeverwaltung die zuständige Entsorgungsstelle.

## Garantie

Gewährleistung und Garantie gemäß der beiliegenden Garantieurkunde.

- Für Reparaturen wenden Sie sich bitte an Ihren Märklin-Fachhändler oder an  
Gebr. Märklin & Cie. GmbH  
Reparaturservice  
Stuttgarter Str. 55 - 57  
73033 Göppingen  
Deutschland  
Tel: 09001 608 222 (nur aus dem Inland\*)  
E-Mail: Service@maerklin.de
- \* Anruf 49CT/Min. bei Anruf aus dem Festnetz, Handytarife können davon deutlich nach oben abweichen.

## CV Programmierung

Die CV Programmierung muss am Programmiergleis erfolgen. Für die Programmierung empfehlen wir, ist eine Lokomotive manuell anzulegen. Werte in Klammern sind die Werkseinstellungen.

Während der Datenübertragung blinkt zur Kontrolle die am Einbau-Digital-Decoder angeschlossene Weichenlaternen.

### fx (MM)

Vor der Programmierung muss die zu programmierende Weiche mit dem Keyboard geschaltet werden. Danach unverzüglich mit der Control Unit bzw. CV Konfiguration der Central Station die CV geändert werden. Danach sofort die programmierte Weiche wieder mit dem Keyboard schalten. Erst jetzt ist die Programmierung übernommen und wirksam.

CV	Bedeutung	Werte	
8	Decoder-Reset	8 (-)	Werkseinstellung, Wert wird nicht geschrieben
36	Weichenlaternen aus/ein	0-1 (1)	

Die Vorgehensweise beim Programmieren mit der Control Unit 6021 entspricht der Lokprogrammierung ([www.maerklin.de](http://www.maerklin.de) -> Tools & Downloads -> Technische Informationen).

## DCC

CV	Bedeutung	Werte	
1	Adresse, niederwertige Byte	0-255 (1)	
7	Hersteller Versionsnummer (Softwareversion)	(-)	nur lesen
8	Hersteller Kennung ID Decoder Reset	(131) 8 (-)	nur lesen, Werkseinstellung, Wert wird nicht geschrieben
9	Adresse, höherwertige Byte	0-7 (0)	
29	Konfiguration	(192)	nur lesen
	Bit 0-4 werden nicht verwendet	0	
	Bit 5: Decodertyp	0 / 32	Basis- o. erweiterter Zubehördecoder
	Bit 6: Adressierungsmethode	0 / 64	Decoder- o. Ausgangsadresse
	Bit 7: Decoderart	128	Zehördecoder
36	Weichenlaternen, aus/ein	0-1 (1)	

### Einstellen und errechnen der Adressen größer 255:

Z.B. Adresse 1044 ->  $1044:256=4,078125$ . Der Wert vor dem Komma (4) ist in CV 9 einzutragen. Den Wert nach dem Komma (0,078125) wird mit 256 multipliziert  $0,078125 \times 256=20$ . Der errechnete Wert 20 muss in CV 1 eingetragen werden.

### Alternative Stromversorgung **Märklin:**

Verbinden Sie das gelbe Kabel mit einer externen Stromquelle. Den anderen freien Pol der externen Stromversorgung verbinden Sie mit dem braunen Kabel des Digital-Stromkreises.

**Das gelbe Kabel des Einbau-Digital-Decoders darf nicht zusätzlich mit dem Digital-Stromkreis verbunden werden.**

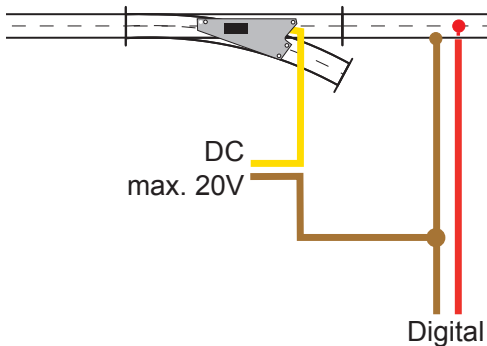

### Alternative Stromversorgung **Trix:**

Durchtrennen Sie das weiße Kabel und verbinden Sie es mit einer externen Stromquelle. Den anderen freien Pol der externen Stromversorgung verbinden Sie mit dem Massekabel (braun/blau) des Digital-Stromkreises.

**Das weiße Kabel des Einbau-Digital-Decoders darf nicht mit dem Digital-Stromkreis verbunden werden.**

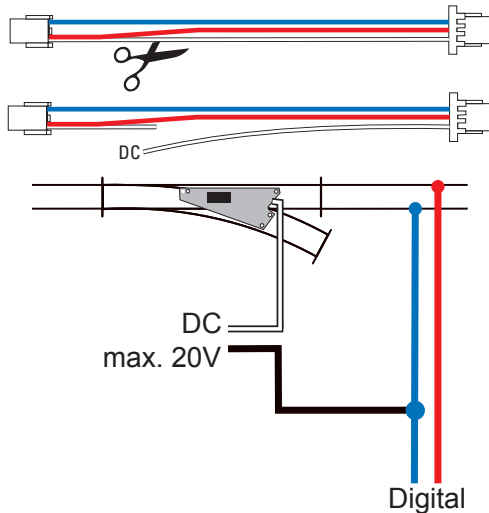

## Normal Use

- This digital installation decoder is designed for installation in Märklin and Trix C Track turnouts with a turnout mechanism (exception: Märklin three-way turnout).
- This digital installation decoder may only be connected to Märklin or Trix switched mode power packs for external power supply.
- This decoder may only be used in dry areas indoors.

### Contents as Delivered

- 1 digital installation decoder
- 1 cable – yellow, red, and brown (for Märklin C Track)
- 1 cable – blue, red, and white (for Trix C Track)
- Installation instructions
- Warranty card

Additional tools required for installation: tweezers and soldering station for a maximum soldering temperature of 30 watts / 300° Celsius / 572° Fahrenheit with a fine point, Electronic solder (0.5-1 mm dia.), desoldering braid or desoldering pump.

## Safety Notes

- **IMPORTANT!** This product has sharp edges and points related to its function.
- Do wiring and assembly work only in a voltage-free work environment. Otherwise you may experience electrical current dangerous to the body leading to injury.
- **Operate this decoder only with the permissible voltage** (see technical information).



When using a solder station there is the danger of **burning your skin.**

## Important Information

- **Important:** When installing the digital installation decoder,

try to avoid touching components on the upper side of the decoder. Static charge can affect the function of the decoder.

- The operating instructions are a component part of the product and must therefore be kept with the product, particularly when it is given to another party.
- For repairs please see your authorized Märklin specialty dealer.
- <http://www.maerklin.com/en/imprint.html>

## Technical Data

- Load at lantern output  $\leq 100$  milliamps
- Load at turnout output max. 2 amps
- Voltage for the digital power circuit max. 20 volts eff.
- External voltage max. 20 volts DC
- Electrical strength max. 40 volts

## Functions

- Capable of multi-protocols: fx (MM) and DCC
- Mode of operation set with DIP switches
- Addresses can be set with DIP switches:
  - 1-256** fx (MM) (Control Unit 6021/Mobile Station 60651/652)
  - 1-320** fx (MM) (Central Station 6021x/Mobile Station 60653)
  - 1-511** (DCC)
- Programmable addresses using CVs
  - 1-2,044** DCC
- Changes to characteristics can be done with CVs
- Digital signal: transfer independent of the power supply
- Power supply done using the digital power circuit
- Alternative power supply
- Solder pads for connections for turnout lanterns
- Turnout lanterns can be turned on or off



## Decoder Installation

The following work steps may only be done in a voltage-free work environment:

- Plug the cable included with the decoder (pay attention to the track system) in the socket provided for it – see page 36/37 (Märklin and Trix). Now follow the illustrated instructions.

See the section “CV Programming” for changes to other characteristics in the fx (MM) protocol using CV programming or to the DCC CV programming.

**Note:** Settings with the DIP switches are to be only when the voltage is turned off. The digital installation decoder does not recognize the current switch settings until the voltage is turned on.

Starting on page 39 you'll find the table for setting addresses with DIP switches.

See page 36 for installation of the digital installation decoder in Märklin standard turnouts, curved turnouts, or double slip switches.

See page 37 for installation of the digital installation decoder in Trix standard turnouts, curved turnouts, or double slip switches.

## Disposal



Information about protecting the environment: Products marked with a trashcan with a line through it may not be disposed of at the end of their useful life along with the normal household trash. They must be taken to a collection point for recycling electrical and electronic devices.

The symbol on the product, the instructions, or the packaging indicates this. Depending on their description, the raw materials can be used again. You make an important contribution to the protection of our environment with the recycling of this material from old devices. Please inquire in your community about the appropriate disposal site.

## Warranty

The warranty terms are stated on the warranty card included with this product.

- Please see your authorized Märklin specialty dealer or Gebr. Märklin & Cie. GmbH  
Reparaturservice  
Stuttgarter Str. 55 - 57  
73033 Göppingen  
Germany  
Tel: +49 7161 608 222 (only from outside of Germany)  
E-mail: Service@maerklin.de

## CV Programming

CV programming must be done on the programming track. We recommend creating a fictitious locomotive for programming purposes. Values in parentheses are the factory settings.

The turnout lantern connected to the digital installation decoder will blink as a control check during the data transmission.

### fx (MM)

Before doing any programming, the turnout to be programmed must be switched with the Keyboard. After that the CVs are changed immediately with the Control Unit or the CV configuration on the Central Station. After that the programmed turnout is to be switched again with the Keyboard. At this point the programming is accepted and is functional.

CV	Meaning	Values	
8	Decoder reset	8 (-)	factory setting, not written value is
36	Turnout lantern off/on	0-1 (1)	

The procedure for programming with the 6021 Control Unit is the same as locomotive programming ([www.maerklin.de](http://www.maerklin.de) -> Tools & Downloads -> Technische Informationen).

## DCC

CV	Meaning	Values	
1	Address, lower value Byte	0-255 (1)	
7	Manufacturer version number (software version)	(-)	read only
8	Manufacture recognition ID Decoder reset	(131) 8 (-)	read only, factory setting, value is not written
9	Address, higher value Byte	0-7 (0)	
29	Configuration	(192)	read only
	Bits 0-4 are not used	0	
	Bit 5: Decoder type	0 / 32	basic or advanced accessory decoder
	Bit 6: Addressing method	0 / 64	decoder or output address
	Bit 7: Decoder type	128	accessory decoder
36	Turnout lantern, off/on	0-1 (1)	

### Setting and generating addresses larger than 255:

Example: Address 1044 -> 1044:256=4,078125. The value before the comma (4) is to be entered in CV 9. The value after the comma (0,078125) is multiplied by 256, 078125x256=20. The value of 20 that is generated must be entered in CV 1.

### Alternative Power Supply for Märklin:

Connect the yellow wire to an external power source. The other available terminal on the external power supply can be connected to the brown wire for the digital power circuit.

**The yellow wire from the digital installation decoder may not be connected with the digital power circuit.**

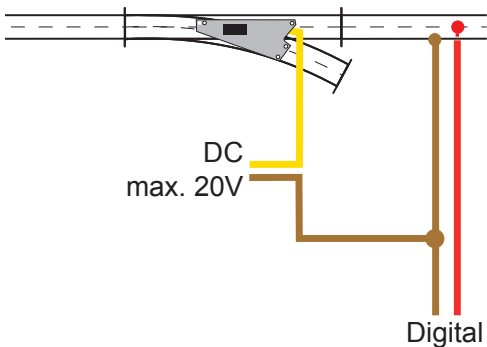

### Alternative Power Supply for Trix:

Cut the white wire as shown and connect it to an external power source. The other available terminal on the external power supply can be connected to the ground wire (brown/blue) for the digital power circuit.

**The white wire from the digital installation decoder may not be connected with the digital power circuit.**

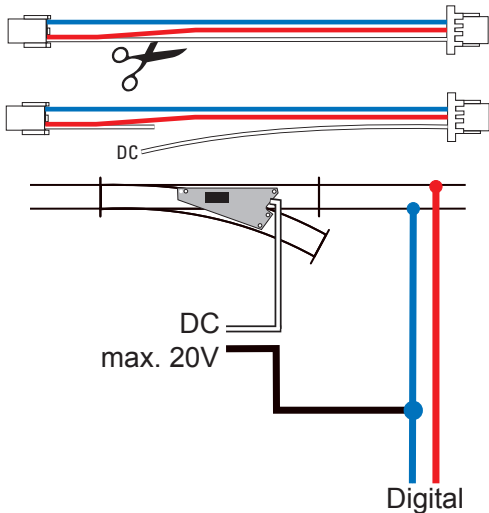

## Usage conforme

- Le décodeur numérique est conçu pour être installé dans des aiguilles de voie C Märklin et Trix équipées d'un moteur (à l'exception des aiguillages triple Märklin).
- Dans le cas d'une alimentation en courant externe, ce décodeur numérique peut être raccordé uniquement à un convertisseur continu-continu Märklin ou Trix.
- A utiliser exclusivement dans des pièces sèches.

### Matériel fourni

1 Décodeur numérique à installer

1 câble de chaque couleur suivante : jaune, rouge et marron (voie C Märklin)

1 câble de chaque couleur suivante : bleu, rouge et blanc (voie C Trix)

Notice d'installation

Bon de garantie

Outils nécessaires à l'installation : Pincette et poste à souder pour une température de brasage maximale de 30 W/300° avec pointe fine, fil à souder pour électronique (Ø 0,5-1 mm), tresse à dessouder ou pompe à dessouder.

## Consignes de sécurité

- **ATTENTION !** L'appareil présente des arêtes coupantes.
- Câblage et montage doivent être réalisés uniquement quand l'appareil est hors tension. Le non respect de ces consignes peut générer des courants de choc dangereux et être à l'origine de blessures.
- **Exploiter le décodeur uniquement avec la tension autorisée** (voir caractéristiques techniques).



Risques de **brûlures** lors de la manipulation du fer à souder.

## Indications importantes

- **Attention :** Lors de l'installation, éviter dans la mesure du possible de toucher les composants situés sur la face supérieure du décodeur numérique, une charge statique pouvant entraver le fonctionnement.
- La notice d'utilisation fait partie intégrante du produit ; elle doit donc être conservée et, le cas échéant, transmise avec le produit.
- Pour toute réparation, adressez-vous SVP à votre détaillant spécialisé Märklin.
- <http://www.maerklin.com/en/imprint.html>

## Caractéristiques techniques

- |                             |                |
|-----------------------------|----------------|
| • Charge sortie lanterne    | ≤ 100 mA       |
| • Charge sortie aiguille    | max. 2 A       |
| • Tension circuit numérique | max. 20 V eff. |
| • Tension externe           | max. 20 V c.c. |
| • Tenue en tension          | max. 40V       |

## Fonctions

- multi protocole: fx (MM) et DCC
- Définition du mode d'exploitation via commutateur DIP
- Définition des adresses possible via commutateur DIP :  
**1-256** fx (MM) (Control Unit 6021/Mobile Station 60651/652)  
**1-320** fx (MM) (Central Station 6021x/Mobile Station 60653)  
**1-511** (DCC)
- Adresses programmables via CV  
**1-2044** DCC
- Modifications des propriétés via CV
- Signal numérique : Transmission indépendante de l'alimentation en courant

- Alimentation en courant via circuit numérique
- Alimentation en courant alternative
- Plages d'accueil pour raccordement de la lanterne d'aiguille
- Lanterne d'aiguille commutable

## Installation du décodeur

**L'installation, dont les différentes étapes sont décrites ci-dessous, doit impérativement être réalisée hors tension :**

- Enfichez le câble fourni (tenir compte du système de voie) dans la prise prévue à cet effet, voir page 36/37 (Märklin et Trix). Suivez alors la notice illustrée.

Pour modifier les autres caractéristiques dans le protocole fx (MM) via la programmation des CV ou pour la programmation des CV dans le protocole DCC, veuillez suivre les indications du chapitre « Programmation des CV ».

**Attention :** Les paramétrages avec le commutateur DIP doivent toujours se faire hors tension. Le décodeur numérique ne reconnaît les nouvelles positions du commutateur qu'à la mise sous tension.

Vous trouverez le tableau pour la définition des adresses avec commutateur DIP à partir de la page 39.

Installation du décodeur numérique dans les aiguillages standard, enroulés ou traversés de jonction double Märklin : voir page 36.

Installation du décodeur numérique dans les aiguillages standard, enroulés ou traversés de jonction double Trix : voir page 37.

## Elimination



Indications relatives à la protection de l'environnement : Les produits marqués du signe représentant une poubelle barrée ne peuvent être éliminés en fin de vie via les ordures ménagères normales, mais doivent être remis à un centre de collecte pour le recyclage des appareils électriques et électroniques. Le symbole figurant sur le produit lui-même, la notice d'utilisation ou l'emballage l'indique. Les matériaux sont recyclables selon leur marquage. Avec le recyclage, la récupération des matériaux ou autres formes de valorisation de vieux appareils, vous contribuez sensiblement à la protection de notre environnement. Renseignez-vous auprès de votre municipalité sur les centres compétents pour le traitement des déchets.

## Garantie

Garantie légale et garantie contractuelle conformément au bon de garantie ci-joint.

- Pour toute réparation, veuillez vous adresser à votre détaillant spécialisé Märklin ou à  
Gebr. Märklin & Cie. GmbH  
Reparaturservice  
Stuttgarter Str. 55 - 57  
73033 Göppingen  
Allemagne  
Tél. : +49 7161 608 222 (uniquement à partir de l'étranger)  
e-mail : Service@maerklin.de

## Programmation des CV

La programmation des CV se fait sur la voie de programmation. Pour la programmation, nous vous conseillons de créer une locomotive fictive. Les valeurs indiquées entre parenthèses correspondent aux paramètres d'usine.

Durant la transmission des données, la lanterne d'aiguille raccordée au décodeur numérique clignote (contrôle).

### fx (MM)

Avant de procéder à la programmation, commutez l'aiguille à programmer via le Keyboard. Modifiez ensuite sans attendre la CV avec la Control Unit, respectivement via la fonction de configuration des CV de la Central Station. Commutez alors à nouveau et immédiatement l'aiguille programmée via le Keyboard. La programmation est enfin enregistrée et effective.

CV	Signification	Valeurs	
8	Réinitialisation du décodeur	8 (-)	Paramètre d'usine, la valeur n'est pas enregistrée
36	Lanterne d'aiguille allumée/éteinte	0-1 (1)	

La procédure à suivre pour la programmation avec la Central Unit 6021 correspond à la programmation de la loco ([www.maerklin.de](http://www.maerklin.de) -> Tools & Downloads -> Technische Informationen)

## DCC

CV	Signification	Valeurs	
1	Adresse, octet de valeur basse	0-255 (1)	
7	Numéro de version fabricant (version logicielle)	(-)	Lire uniquement
8	Identifiant du fabricant Réinitialisation du décodeur	8 (131) (-)	Lire uniquement, paramètre d'usine, la valeur n'est pas enregistrée
9	Adresse, octet de valeur supérieure	0-7 (0)	
29	Configuration	(192)	Lire uniquement
	Bits 0 à 4 non utilisés	0	
	Bit 5: Type de décodeur	0 / 32	Décodeur d'accessoires de base ou avancé
	Bit 6: Méthode d'adressage	0 / 64	Adresse du décodeur ou adresse de départ
	Bit 7: Type de décodeur	128	Décodeur d'accessoires
36	Lanterne d'aiguille allumée/éteinte	0-1 (1)	

### Définition et calcul des adresses supérieures à 255 :

Par ex. Adresse 1044 ->  $1044:256=4,078125$ . La valeur avant la virgule (4) est à reporter dans la CV 9. La valeur située après la virgule (0,078125) est multipliée par 256  $0,078125 \times 256=20$ . La valeur calculée 20 est à reporter dans la CV 1.

### Alimentation en courant alternative **Märklin** :

Reliez le câble jaune à une source d'alimentation extérieure. Reliez le second pôle libre de l'alimentation en courant extérieure avec le câble marron du circuit électrique numérique.

**Le câble jaune du décodeur numérique ne doit en aucun cas être raccordé au circuit électrique numérique.**

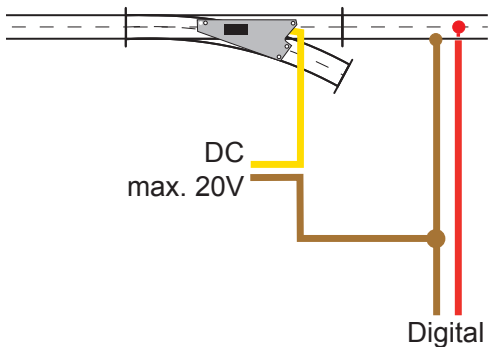

### Alimentation en courant alternative **Trix** :

Sectionnez le câble blanc et reliez-le à une source d'alimentation en courant extérieure. Reliez le second pôle libre de l'alimentation en courant extérieure avec le câble de masse (marron/bleu) du circuit électrique numérique.

**Le câble blanc du décodeur numérique ne doit en aucun cas être raccordé au circuit électrique numérique.**

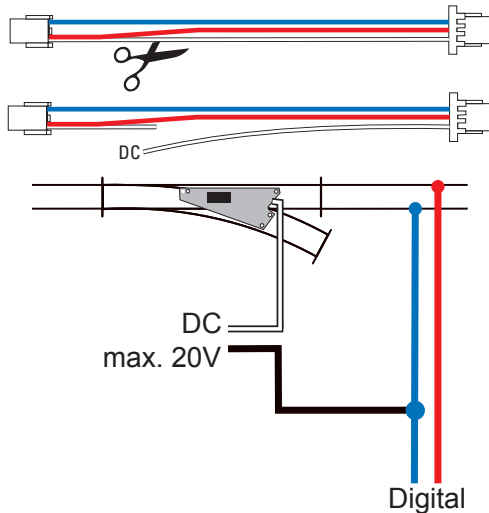

## Beoogd gebruik

- De inbouw-digitaaldecoder is bedoeld voor het inbouwen in Märklin- en Trix C-rail wissels met wisselaandrijving (uitgezonderd de Märklin driewegwissel).
- De inbouw-digitaaldecoder mag bij het gebruik van een externe voeding alleen aan een Märklin of Trix netadapter aangesloten worden.
- Mag alleen in droge ruimtes gebruikt worden.

### Leveringsomvang

1 inbouw-digitaaldecoder

1 kabel geel, rood en bruin (C-rail Märklin)

1 kabel blauw, rood en wit (C-rail Trix)

Gebruiksaanwijzing

Garantiebewijs

Voor het inbouwen is het volgende gereedschap nodig: pincet en soldeerstation met een maximale temperatuur van 30W/300 OC met een dunne stift, elektronica soldeertin (0.5 - 1mm), desoldeerlitze of soldeertinzuiger.

## Veiligheidsvoorschriften

- **Let op!** bevat vanwege zijn functie scherpe randen en punten.
- bedrading- en montage alleen in spanningloze toestand uitvoeren. Bij het niet naleven kunnen er gevaarlijke stromen door het lichaam vloeien en verwondingen ontstaan.
- **Decoder alleen met de toegelaten spanning** (zie technische gegevens) **gebruiken**.



Bij het werken met een soldeerbout bestaat het gevaar voor **brandwonden**.

## Belangrijke aanwijzingen

- **Let op:** bij het inbouwen de delen op de bovenzijde van de inbouw-digitaaldecoder niet aanraken, statische ontlading kan de juiste werking beïnvloeden.
- De gebruiksaanwijzing is onderdeel van het product en moet derhalve bij de overdracht van het product meegegeven worden.
- Voor reparaties kunt u zich tot uw Märklin dealer wenden.
- <http://www.maerklin.com/en/imprint.html>

## Technische gegevens

- |                                 |                |
|---------------------------------|----------------|
| • Belasting lantaarnuitgang     | <100mA         |
| • Belasting wisseluitgang       | max. 2A        |
| • Spanning digitale stroomkring | max. 20 V eff. |
| • Spanning extern               | max. 20 V DC   |
| • Diëlektrische sterkte         | max. 40 V      |

## Werking

- Multiprotocol: fx (MM) en DCC
- Instellen van het bedrijfssysteem met DIP-schakelaar
- Instellen van het adres met DIP-schakelaar  
**1-256** fx (MM) (Control Unit 6021/Mobile Station 60651/652)  
**1-320** fx (MM) (Central Station 6021x/Mobile Station 60653)  
**1-511** (DCC)
- Programeerbare adressen via CV  
**1-2044** DCC
- Wijzigen van de eigenschappen via CV
- Digitaal signaal: overdracht onafhankelijk van de stroomvoorziening.
- Stroomvoorziening via digitale stroomkring
- Alternatieve stroomvoorziening
- Soldeervelden voor het aansluiten van de wissellantaarn
- Wissellantaarn uit- en inschakelbaar



## Decoder inbouwen

De volgende stappen mogen alleen in spanningloze toestand uitgevoerd worden:

- Steek de stekker van meegeleverde kabel (let op het railsysteem) in de daarvoor bestemde stekkerbus, zie pagina 36/37 (Märklin en Trix). Volg de afgebeelde aanwijzingen.

Veranderen van de te wijzigende eigenschappen in het fx (MM) protocol door CV programmering of het DCC CV programmering vindt u in het hoofdstuk "CV programmering".

**Let op:** instellingen van de DIP-schakelaars alleen in spanningloze toestand uitvoeren. De inbouw-digitaaldecoder herkent de actuele schakelaarstand pas na het inschakelen van de voedingsspanning.

Vanaf pagina 39 vindt u de tabel voor de adressering met de DIP-schakelaars.

Inbouw van de inbouw-digitaaldecoder in de Märklin standaard-meegebogen- en kruiswissels zie pagina 36.

Inbouw van de inbouw-digitaaldecoder in de Trix standaard-meegebogen- en kruiswissels zie pagina 37.

## Afdanken



Milieu-informatie: producten, die met de doorgestreepte afvalcontainer zijn gemarkeerd, mogen aan het einde van hun levensduur niet met het normale huisvuil meegegeven worden, maar moeten op een verzamelpunt voor de recycling van elektrische en elektronische apparatuur afgegeven worden. Het symbool op het product, op de handleiding of op de verpakking geeft dit aan. De materialen worden gerecycled in overeenstemming met hun identificatie. Met het hergebruik van de grondstoffen of andere vormen van het hergebruik van oude apparatuur levert u een belangrijke bijdrage aan de bescherming van ons milieu. Neem contact op met uw gemeente voor een bevoegde plaatselijke inzamelplaats.

## Garantie

Waarborg en garantie volgens bijgevoegd garantiebewijs.

- Voor reparaties kunt u zich wenden tot uw Märklin dealer of tot  
Gebr. Märklin & Cie. GmbH  
Reparaturservice  
Stuttgarter Str. 55 - 57  
73033 Göppingen  
Duitsland  
Tel: +49 7161 608 222 (Alleen buiten Duitsland)  
E-Mail: Service@maerklin.de

## CV Programmering

De CV programmering moet via het programmeerspoor gebeuren. Voor het programmeren is het aan te bevelen een fictive loc aan te maken. De waarden tussen haakjes zijn de af fabriek ingestelde waarden.

Tijdens de dataoverdracht knippert, ter controle, de aan de inbouw-digitaaldecoder aangesloten wisselantaarn.

### fx (MM)

Voor het programmeren moet de te programmeren wissel met het keyboard geschakeld worden. Daarna onmiddellijk met de Control Unit resp. via CV configuratie met het Central Station de CV wijzigen. Daarna direct de geprogrammeerde wissel met het keyboard schakelen. Pas dan is de programmering overgenomen en werkzaam.

CV	Omschrijving	Waarde	
8	Decoder reset	8 (-)	Fabrieksinstelling, waarde wordt niet geschreven
36	Wisselantaarn uit/aan	0-1 (1)	

De werkwijze bij het programmeren met de Control Unit 6021 komt overeen met het programmeren van een locomotief-decoder ([www.maerklin.de](http://www.maerklin.de) -> Tools & Downloads -> Technische Informationen).

## DCC

CV	Omschrijving	Waarde	
1	Adres, lage byte	0-255 (1)	
7	Fabrikant versienummer (softwareversie)	(-)	alleen lezen
8	Fabrikant kenmerk ID decoder reset	(131) 8 (-)	alleen lezen, fabrieksinstelling, waarde wordt niet geschreven
9	Adres, hoge byte	0-7 (0)	
29	Configuratie	(192)	alleen lezen
	Bit 0-4 worden niet gebruikt	0	
	Bit 5: decodertype	0 / 32	Basis- of uitgebreide toebehoren decoder
	Bit 6: adresseringsmethode	0 / 64	Decoder of uitgangsadres
	Bit 7: decodertype	128	Toebehoren decoder
36	Wisselantaarn uit/aan	0-1 (1)	

### Instellen en berekenen van de adressen groter dan 255:

Bijv. adres 1044 ->  $1044:256=4,078125$ . De waarde voor de komma (4) moet in CV 9 ingevoerd worden. De waarde achter de komma (0,078125) wordt nu met 256 vermenigvuldigd  $0,078125 \times 256 = 20$ . De berekende waarde 20 moet in CV 1 ingevoerd worden.

### Alternatieve stroomvoorziening Märklin:

Verbind de gele draad met een externe stroombron. De andere vrije aansluiting van de externe stroombron moet worden verbonden met de bruine draad van de digitale stroomkring.

**De gele draad van de inbouw-digitaaldecoder mag niet met de digitale stroomkring verbonden worden.**

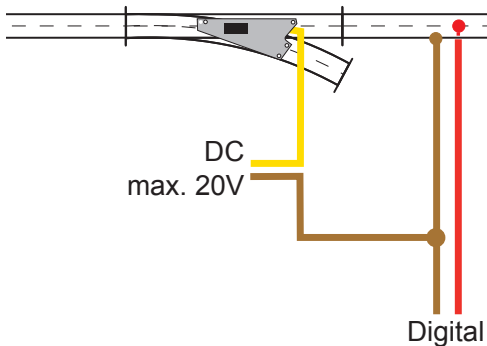

### Alternatieve stroomvoorziening Trix:

Knip de witte draad door en verbind deze draad met een externe stroombron. De andere vrije aansluiting van de externe stroombron moet worden verbonden met de massadraad (bruine/blauwe) draad van de digitale stroomkring.

**De witte draad van de inbouw-digitaaldecoder mag niet met de digitale stroomkring verbonden worden.**

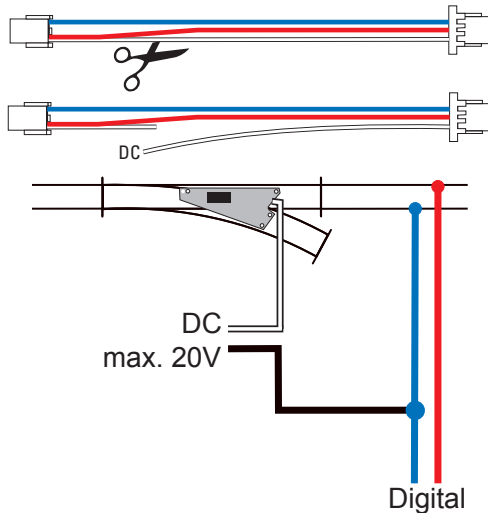

## Uso previsto

- El decoder digital integrable está destinado para el montaje en desvíos para vías C de Märklin y Trix con accionamiento de aguja (con excepción del desvío de tres itinerarios de Märklin).
- Está permitido conectar el decoder digital integrable, en el caso de alimentación externa, únicamente a fuentes de alimentación conmutadas de Märklin o de Trix.
- Su uso está permitido únicamente en recintos secos.

### Alcance de suministro

1 decoder digital integrable

1 cable amarillo, rojo y marrón (vía C de Märklin)

1 cable azul, rojo y blanco (vía C de Trix)

Instrucciones de montaje

Documento de garantía

Herramienta adicional necesaria para el montaje: Pinza y estación de soldadura para una temperatura de soldeo de máx. 30W/300° con punta fina, estaño de soldar para electrónica (Ø 0,5-1 mm), cordón de desoldeo o bomba aspiradora de desoldeo.

## Instrucciones de seguridad

- **¡ATENCIÓN!** El diseño presenta aristas y puntas cortantes impuestas por las características funcionales.
- Ejecutar los trabajos de cableado y montaje únicamente sin tensión. En el caso de inobservancia pueden producirse corrientes peligrosas a través del cuerpo y, por tanto, lesiones.
- **Utilizar el decoder únicamente con la tensión admisible** (véase Datos técnicos).



Al manejar el soldador pueden producirse **quemaduras de la piel.**

## Notas importantes

- **Atención:** En el montaje, a ser posible, no tocar componentes situados en el lado superior del decoder digital integrable ya que las cargas estáticas pueden perjudicar a su funcionamiento.
- Las instrucciones de empleo forman parte integrante del producto y, por este motivo, deben conservarse y entregarse al nuevo comprador en el caso de venta del mismo.
- Para reparaciones, por favor diríjase a su distribuidor especializado de Märklin.
- <http://www.maerklin.com/en/imprint.html>

## Datos técnicos

- |                               |                |
|-------------------------------|----------------|
| • Carga por salida de farol   | ≤ 100 mA       |
| • Carga por salida de desvío  | max. 2 A       |
| • Tensión de circuito digital | máx. 20 V efi. |
| • Tensión externa             | máx. 20 V DC   |
| • Rigidez dieléctrica         | máx. 40 V      |

## Funciones

- Apto para múltiples protocolos: fx (MM) y DCC
- Configuración del modo mediante microinterruptor DIP
- Direcciones configurables mediante interruptor DIP:  
**1-256** fx (MM) (Control Unit 6021/Mobile Station 60651/652)  
**1-320** fx (MM) (Central Station 6021x/Mobile Station 60653)  
**1-511** (DCC)
- Direcciones programables mediante variables CV  
**1-2.044** DCC
- Modificación de las características mediante variables CV
- Señal digital: Transmisión independiente de la alimentación eléctrica
- Alimentación eléctrica mediante circuito digital

- Alimentación eléctrica alternativa
- Terminales de soldadura para conexión de farol de aguja
- Farol de aguja activable o desactivable

## Montaje del decoder

**Está permitido ejecutar las siguientes operaciones únicamente sin tensión.**

- Enchufe el cable incluido (tener presente el sistema de vías) en el conector hembra para ello previsto, véase página 36/37 (Märklin y Trix). Siga ahora las instrucciones ilustradas.

En el capítulo “Programación de las CVs” se explican las modificaciones de las demás características en el protocolo fx (MM) mediante programaciones de variables CV o para la programación de variables CV en el protocolo DCC.

**Nota importante:** Realizar los ajustes con el microinterruptor DIP siempre sin tensión. El decoder digital integrable no reconoce las posiciones actuales de los microinterruptores hasta que no se enciende la alimentación eléctrica.

A partir de la página 39 encontrará la tabla para el direccionamiento con microinterruptores DIP.

Para el montaje del decoder digital integrable en un desvío estándar, un desvío en curvas o una travesía de unión doble de Märklin, véase Página 36.

Para el montaje del decoder digital integrable en un desvío estándar, un desvío en curvas o una travesía de unión doble de Trix, véase Página 37.

## Eliminación



Indicaciones para protección del medio ambiente: Los productos identificados con el cubo de basura tachado no deben eliminarse junto con la basura doméstica normal y corriente una vez alcanzado el final de su vida útil, sino que deben entregarse en un punto de recogida para el reciclaje de equipos eléctricos y electrónicos. El símbolo que aparece en el producto, en las instrucciones de empleo o en el embalaje hace referencia a ello. Los materiales son reutilizables conforme a su identificación. Con la reutilización, el aprovechamiento de los materiales u otras formas de reciclado de aparatos viejos hacemos una aportación importante a la protección del medio ambiente. Consulte en su Ayuntamiento cuál es la entidad de recogida competente.

## Garantía

La garantía legal y la garantía del fabricante se basan en el documento de garantía adjunto.

- Para reparaciones, diríjase a su distribuidor profesional de Märklin-  
o a  
Gebr. Märklin & Cie. GmbH  
Reparaturservice  
Stuttgarter Str. 55 - 57  
73033 Göppingen  
Alemania  
Tel: +49 7161 608 222 (sólo desde fuera de Alemania)  
E-Mail: Service@maerklin.de

## Programación de variables CV

La programación de variables CV debe realizarse en la vía de programación. Para la programación recomendamos crear una locomotora ficticia. Los valores entre paréntesis representan la configuración de fábrica.

Durante la transmisión de datos, para comprobación, destella el farol de aguja conectado al decoder digital integrable.

### fx (MM)

Antes de la programación, debe conmutarse con el Keyboard el desvío que se desee programar. Inmediatamente después debe modificarse la CV con la Control Unit o bien con la función Configuración de CV de la Central Station. A continuación, conmutar de nuevo inmediatamente el desvío programado. Hasta que esto no se haya hecho no se aplicará ni tendrá efecto la programación.

CV	Significado	Valores	
8	Reset de decoder	8 (-)	Configuración de fábrica, no se escribe el valor
36	Apagar/encender farol de aguja	0-1 (1)	

El procedimiento en la programación con la Central Unit equivale a la programación de locomotora ([www.maerklin.de](http://www.maerklin.de) -> Tools & Downloads -> Technische Informationen).

## DCC

CV	Significado	Valores	
1	Dirección, byte de menor peso	0-255 (1)	
7	Número de versión de fabricante (versión de software)	(-)	Sólo lectura
8	ID ident. de fabricante Reset de decoder	(131) 8 (-)	Sólo lectura, configuración de fábrica, no se escribe el valor
9	Dirección, byte de mayor peso	0-7 (0)	
29	Configuración	(192)	Sólo lectura
	Bit 0-4 No se utilizan los bits	0	
	Bit 5: Modelo de decoder	0 / 32	Decoder accesorio básico o ampliado
	Bit 6: Método de direccionamiento	0 / 64	Dirección de decoder o inicial
	Bit 7: Tipo de decoder	128	Decoder accesorio
36	Desactivar/activar farol de desvío	0-1 (1)	

### Configuración y cálculo de las direcciones mayores que 255:

P. ej., dirección 1044 ->  $1044:256=4,078125$ . El valor antes de la coma (4) debe registrarse en la CV 9. El valor después de la coma (0,078125) se multiplica por 256  $0,078125 \times 256=20$ . El valor calculado 20 debe registrarse en CV 1.

### Alimentación eléctrica de Märklin:

Conecte el cable amarillo a una fuente de corriente externa.  
Conecte el otro polo libre de la alimentación eléctrica externa al cable marrón del circuito digital.

**El cable amarillo del decoder digital integrable no debe conectarse con el circuito digital.**

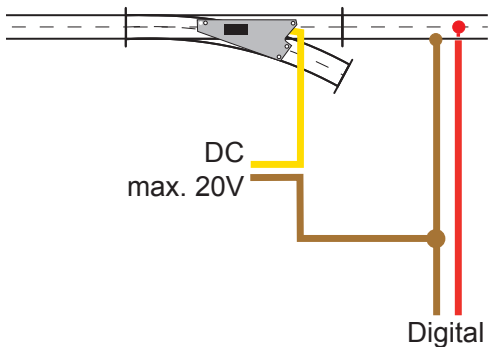

### Alimentación eléctrica alternativa Trix:

Seccione el cable blanco y conéctelo a una fuente de corriente externa.  
Conecte el otro polo libre de la fuente de alimentación externa al cable de masa (marrón/azul) de circuito digital.

**El cable blanco del decoder digital integrable no debe conectarse al circuito digital.**

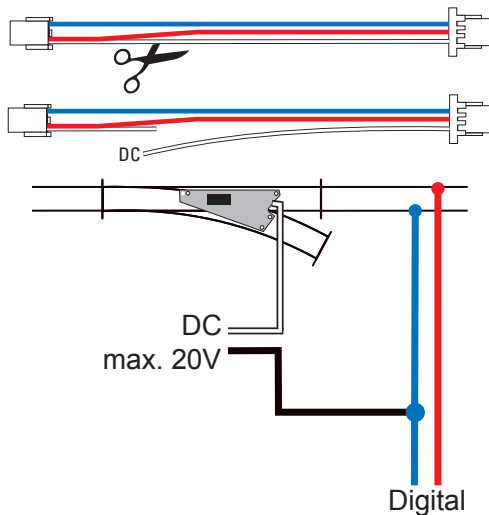

## Impiego commisurato alla destinazione

- Tale Decoder Digital installabile è destinato al montaggio nei deviatori del binario Märklin e Trix C con azionamento per deviatori (ad eccezione dei deviatori a tre vie Märklin).
- Tale Decoder Digital installabile in caso di un'alimentazione di corrente esterna deve venire collegato solamente ad alimentatori «switching» da rete Märklin o rispettivamente Trix.
- Deve essere impiegato solamente in luoghi asciutti.

### Corredo di fornitura

1 Decoder Digital installabile

1 cavetto giallo, rosso e marrone (binario Märklin C)

1 cavetto blu, rosso e bianco (binario Trix C)

Istruzioni di montaggio

Certificato di garanzia

Attrezzi necessari in aggiunta per il montaggio: una pinzetta e una stazione di saldatura per una temperatura di saldatura sino a un max. di 30W/300° con una punta sottile, lega per saldature elettroniche (Ø 0,5-1 mm), trecciola dissaldante oppure pompetta aspirante per dissaldare.

## Avvertenze di sicurezza

- **ATTENZIONE!** Spigoli e punte affilati per necessità funzionale.
- Si eseguano i lavori di cablaggio e di montaggio solo in condizioni esenti da tensione. In caso di mancato rispetto questo può condurre a pericolose correnti nel corpo e di conseguenza a ferimenti.
- **Si faccia funzionare il Decoder solamente con la tensione ammissibile** (si vedano i dati tecnici).



Durante le operazioni con il saldatore sussiste il pericolo di **scottature della pelle**.

## Avvertenze importanti

- **Attenzione:** durante il montaggio si tocchino il meno possibile i componenti sul lato superiore del Decoder Digital installabile, le cariche statiche possono compromettere la funzionalità.
- Le istruzioni di impiego costituiscono parte integrante del prodotto e devono pertanto venire conservate con cura nonché consegnate insieme in caso di cessione a terzi del prodotto.
- Per riparazioni Vi preghiamo di rivolgerVi al Vostro rivenditore specialista Märklin.
- <http://www.maerklin.com/en/imprint.html>

## Dati tecnici

- Carico dell'uscita per lanterne  $\leq 100$  mA
- Carico dell'uscita per deviatori max. 2 A
- Tensione nel circuito di corrente Digital max. 20 V eff.
- Tensione esterna max. 20 V DC
- Rigidità dielettrica max. 40 V

## Funzioni

- Capacità multi-protocollo: fx (MM) und DCC
- Impostazione del tipo di funzionamento a mezzo commutatori DIP
- Indirizzi impostabili con commutatori DIP:  
**1-256** fx (MM) (Control Unit 6021/Mobile Station 60651/652)  
**1-320** fx (MM) (Central Station 6021x/Mobile Station 60653)  
**1-511** (DCC)
- Indirizzi programmabili tramite CV  
**1-2.044** DCC
- Modificazione delle caratteristiche tramite CV
- Segnale Digital: trasmissione indipendente dall'alimentazione di corrente
- Alimentazione di corrente tramite circuito di corrente Digital



- Alimentazione di corrente alternativa
- Piazzole da saldare per collegamento della lanterna da deviatoi
- Lanterna da deviatoi disattivabile o attivabile

## Montaggio del Decoder

**I seguenti passaggi del lavoro devono essere eseguiti solamente in condizioni esenti da tensione.**

- Innestate il cavetto fornito in dotazione (si presti attenzione al sistema dei binari) nella presa predisposta a tale scopo, si veda a pagina 36/37 (Märklin e Trix). Seguite adesso le istruzioni illustrate.

Per modificazioni delle altre caratteristiche nel protocollo fx (MM) mediante programmazione delle CV oppure per programmazione delle CV in DCC seguite il capitolo «Programmazione delle CV.»

**Prestate attenzione:** si intraprendano le impostazioni con il commutatore DIP sempre senza tensione. Il Decoder Digital installabile riconosce le attuali disposizioni del commutatore solo con l'attivazione della tensione.

A partire da pagina 39 potete trovare la tabella per l'indirizzamento con il commutatore DIP.

Per il montaggio del Decoder Digital installabile in deviatoi Märklin normali, curvi oppure deviatoi inglesi doppi si veda a pagina 36.

Per il montaggio del Decoder Digital installabile in deviatoi Trix normali, curvi oppure deviatoi inglesi doppi si veda a pagina 37.

## Smaltimento



Avvertenze per la salvaguardia ambientale: i prodotti che sono contraddistinti con la pattumiera cancellata, alla fine della loro durata di vita non devono venire smaltiti tramite i normali rifiuti domestici, bensì devono venire conferiti ad un punto di raccolta per il riciclo di apparecchi elettrici ed elettronici. Tale simbolo sul prodotto, sulle istruzioni di impiego oppure sulla confezione dà avviso di questo. I materiali sono nuovamente utilizzabili in conformità al loro simbolo di riconoscimento. Con il riutilizzo, la valorizzazione dei materiali oppure altre forme di recupero degli apparecchi vecchi Voi fornite un importante contributo alla salvaguardia del nostro ambiente. Vi preghiamo di chiedere presso la Vostra amministrazione municipale i punti di smaltimento autorizzati.

## Garanzia

Prestazioni di garanzia e garanzie in conformità all'accluso certificato di garanzia.

- Per riparazioni Vi preghiamo di rivolgerVi al Vostro rivenditore specialista Märklin oppure a  
Gebr. Märklin & Cie. GmbH  
Reparaturservice  
Stuttgarter Str. 55 - 57  
73033 Göppingen  
Deutschland  
Tel: +49 7161 608 222 (solo da fuori dell Germania)  
E-Mail: Service@maerklin.de

## Programmazione delle CV

La programmazione delle CV deve avvenire sul binario di programmazione. Per tale programmazione noi consigliamo di inserire una locomotiva immaginaria. I valori tra parentesi sono le impostazioni di fabbrica.

Durante la trasmissione dei dati lampeggia per controllo la lanterna da deviatoi collegata al Decoder Digital installabile.

### fx (MM)

Prima della programmazione il deviatioio da programmare deve venire commutato con la Keyboard. Dopo di ciò le CV vengono immediatamente modificate con la Control Unit o rispettivamente la configurazione CV della Central Station. Dopodiché si commuti subito nuovamente il deviatioio programmato con la Keyboard. Soltanto ora la programmazione è acquisita ed operativa.

CV	Significato	Valori	
8	Ripristino Decoder	8 (-)	Impostazioni di fabbrica, il valore non viene scritto
36	Lanterna da deviatoi spenta/ accesa	0-1 (1)	

Il modo operativo nella programmazione con la Central Unit 6021 corrisponde alla programmazione della locomotive ([www.maerklin.de](http://www.maerklin.de) -> Tools & Downloads -> Technische Informationen).

## DCC

CV	Significato	Valori	
1	Indirizzo, byte di valore più basso	0-255 (1)	
7	Numero di versione del fabbricante (Versione Software)	(-)	sola lettura
8	ID identificativo del fabbricante Ripristino Decoder	8 (131) (-)	sola lettura, Impostazioni di fabbrica, il valore non viene scritto
9	Indirizzo, byte di valore più alto	0-7 (0)	
29	Configurazione	(192)	sola lettura
	I bit 0-4 non vengono usati	0	
	Bit 5: tipo di Decoder	0 / 32	Decoder per accessori di base o esteso
	Bit 6: metodo di indirizzamento	0 / 64	Indirizzo Decoder o di uscita
	Bit 7: tipo di Decoder	128	Decoder per accessori
36	Lanterna da deviatoi spenta/accesa	0-1 (1)	

### Impostazione e calcolo degli indirizzi maggiori di 255:

Ad es. indirizzo 1044 -> 1044:256=4,078125 . Il valore prima della virgola (4) si deve inserire in CV 9. Il valore dopo la virgola (0,078125) viene moltiplicato per 256: 0,078125x256=20. Il valore calcolato 20 deve venire inserito in CV 1.

### Alimentazione di corrente alternativa Märklin:

Vogliate collegare il cavetto giallo con una sorgente di corrente esterna. L'altro polo libero dell'alimentazione di corrente esterna collegatelo con il cavetto marrone del circuito di corrente Digital.

**Il cavetto giallo del Decoder Digital installabile non deve venire collegato con il circuito di corrente Digital.**

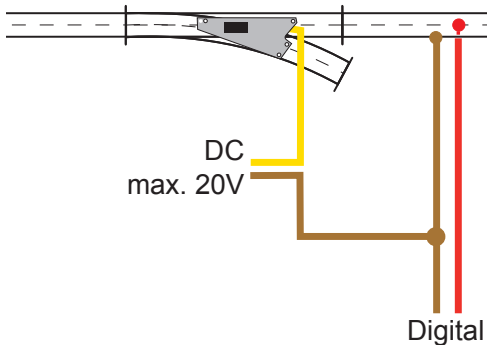

### Alimentazione di corrente alternativa Trix:

Vogliate sezionare il cavetto bianco e collegatelo con una sorgente di corrente esterna. L'altro polo libero dell'alimentazione di corrente esterna collegatelo con il cavetto di massa (marrone/ blu) del circuito di corrente Digital.

**Il cavetto bianco del Decoder Digital installabile non deve venire collegato con il circuito di corrente Digital.**

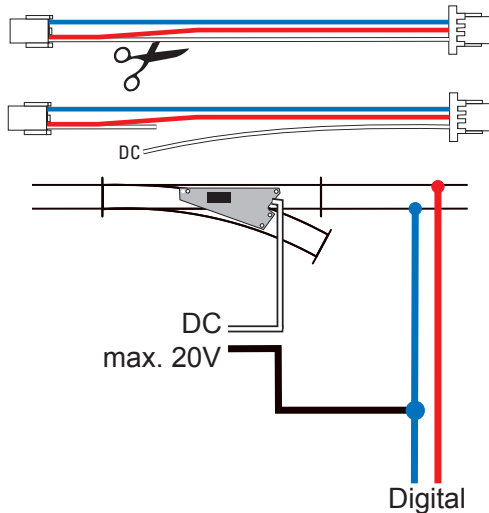

## Användningsområde

- Inbyggnadsdekodern är avsedd för att byggas in i Märklin- och Trix-C-växlar med växelmotorer (undantaget Märklins trevägsväxlar).
- Inbyggnadsdekodern får vid extern strömförsörjning endast anslutas till Märklins eller Trix nätenhet.
- Den får endast användas i torra rum och utrymmen.

### Ingående material vid leverans

1 inbyggnadsdeko

1 gul, röd och brun kabel (Märklin C-räls)

1 blå, röd och vit kabel (Trix-C-räls)

Inbyggnadsanvisningar

Garantisedel

För inbyggnaden fordras följande verktyg: Pincett och lödstation med tunn lödspets för en lödtemperatur av 30W/300°, elektroniklötten (Ø 0,5 - 1 mm), avlödningsfläta eller tennsug.

## Säkerhetsanvisningar

- **WARNING!** Funktionsbetingade skarpa kanter och spetsiga delar.
- Anslutning av kablar och montagearbeten får endast göras i spänningslöst tillstånd. Om dessa anvisningar ej följs kan det leda till farliga strömmar och strömstyrkor som kan åsamka kroppsskada.
- **Dekodern får endast drivas med angiven spänning** (se tekniska data).



Vid hantering av lödkolven måste risken för **hud- och brännskador beaktas**.

## Viktig information

- **Warning:** Vid montage, undvik att beröra inbyggnadsdekoderns ovansida, statisk elektricitet kan skada dekoderns funktioner.
- Bruksanvisningen tillhör produkten och måste därför sparas och medfölja produkten om den överläts till annan ägare.
- För eventuella reparationer vänder man sig till sin Märklin-fackhandel.
- <http://www.maerklin.com/en/imprint.html>

## Tekniska data

- |                              |                |
|------------------------------|----------------|
| • Belastning lyktutgång      | ≤ 100 mA       |
| • Belastning växelutgång     | max. 2 A       |
| • Spänning digitalströmkrets | max. 20 V eff. |
| • Spänning externt           | max. 20 V DC   |
| • Spänningsstyrka            | max. 40 V      |

## Funktioner

- För multiprotokoll: fx (MM) och DCC
- Inställning med DIP-switchar
- Inställbara adresser med DIP-switchar  
**1-256** fx (MM) (Control Unit 6021/Mobile Station 60651/652)  
**1-320** fx (MM) (Central Station 6021x/Mobile Station 60653)  
**1-511** (DCC)
- Programmerbara adresser via CV  
**1-2.044** DCC
- Ändringar av egenskaper via CV
- Digitalsignal: Överföring oberoende av strömförsörjningen.
- Strömförsörjning via digitalströmkrets
- Alternativ strömförsörjning
- Löddöar för anslutning av växellyktan
- Växellyktan kan kopplas till och från

## Inbyggnad av dekodern

### Följande åtgärder får endast utföras i spänningslöst tillstånd.

- Stick in de medföljande kablarna (tänk därvid på vilket rälssystem som används) i de därför avsedda anslutningspunkterna, se sidan 36/37 (Märklin och Trix). Följ anvisningarna på bilderna.

Ändringar av andra egenskaper i fx (MM) protokoll via CV programmering eller via DCC CV-programmering görs enligt anvisningarna i kapitlet "CV programmering".

**Observera:** Inställningar av DIP-switcharna får endast göras i spänningslöst tillstånd. Inbyggnadsdekodern godkänner inte de aktuella inställningarna förrän spänningen kopplas på.

På sidan 39 återfinns tabeller för ändringar av DIP-switcharna intällningar.

För montering av inbyggnadsdekodrar i Märklins standardväxlar, kurvväxlar och dubbelkorsväxlar, v.g. se sidan 36.

För montering av inbyggnadsdekodrar i Trix standardväxlar, kurvväxlar och dubbelkorsväxlar, v.g. se sidan 37.

## Källsortering



Observera miljöskyddsbestämmelserna: Produkter märkta med symbolen som föreställer en överkorsad soptunna, får när de förbrukats inte hanteras som normalt hushållsavfall, utan skall lämnas in till en återvinningsstation som tar emot kasserade elapparater och elektronikavfall.

Återvinning av materialet i sådana förbrukade apparater och elektronik är ett viktigt bidrag till miljöskyddet. Vid tveksamhet: Kontakta miljöskyddet i din hemkommun och fråga efter en återvinningsstation som tar emot el- och elektronikavfall.

## Garanti

Omfattning av tillverkaransvar och garantier framgår av bifogad garantisedel.

- För reparationer vänder man sig till sin Märklin-fackhandel eller till  
Gebr. Märklin & Cie. GmbH  
Reparaturservice  
Stuttgarter Str. 55 - 57  
73033 Göppingen  
Tyskland  
Tel: +49 7161 608 222 (endast utanför Tyskland)  
email: Service@maerklin.de

## CV programmering

CV programmering måste göras på programmeringsspåret. För programmeringen rekommenderar vi att man lägger till ett fiktivt lok. Värden angivna inom klammer är fabriksinställningarna.

För kontroll: Under dataöverföringen blinkar den till inbyggnadsdekodern anslutna växellyktan.

### fx (MM)

Innan programmeringen måste den aktuella växeln som ska programmeras kopplas och styras via Keyboard. Därefter måste CV ändras omedelbart via Control Units eller t.ex. Central Stations CV konfiguration. Därefter skall den programmerade växeln omedelbart åter kopplas och styras via Keyboard. Först då är programmeringen slutförd och fungerar.

CV	Betydelse	Värden	
8	Dekoder-reset	8 (-)	Fabriksinställningar, värden sparas ej
36	Växellykta till/från	0-1 (1)	

Tillvägagångssättet vid programmering med Central Unit 6021 motsvarar lokprogrammeringen ([www.maerklin.de](http://www.maerklin.de) -> Tools & Downloads -> Technische Informationen).

## DCC

CV	Betydelse	Värden	
1	Adresser, lågvärdiga Byte	0-255 (1)	
7	Tillverkarens versionsnummer (Mjukvaruversion)	(-)	endast läsning
8	Tillverkarens ID Dekoder reset	8 (131) (-)	endast läsning, fabriksinställning, värden sparas ej
9	Adresser, högvärdiga Byte	0-7 (0)	
29	Konfiguration	(192)	endast läsning
	Bit 0-4 används ej	0	
	Bit 5: Dekodertyp	0 / 32	Standarddekoder- eller tillagd tillbehörsdekoder
	Bit 6: Adresseringsmetod	0 / 64	Dekoder- eller utgångsadress
	Bit 7: Dekodersort	128	Tillbehörsdekoder
36	Växellykta, från/till	0-1 (1)	

### Inställning och åtkomst av adresser högre än 255:

T.ex. adress 1044 ->  $1044:256 = 4,078125$ . För in detta värde före kommatecknet (4) i CV 9. Värdet efter kommatecknet (0,078125) multipliceras med 256,  $0,078125 \times 256 = 20$ . Det erhållna värdet måste införas i CV 1.

### Alternativ strömförsörjning **Märklin:**

Den gula kabeln skall anslutas till en extern strömkälla. Den andra polen på den externa strömkällan ansluts till den digitala strömkretsens bruna kabel.

**Inbyggnadsdekoderns gula kabel får absolut INTE komma i kontakt med den digitala strömkretsen.**

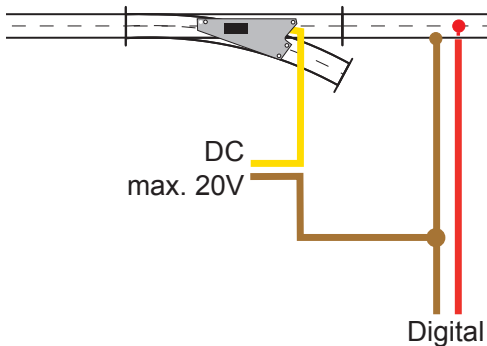

### Alternativ strömförsörjning **Trix:**

Separera den vita kabeln och koppla den till en extern strömkälla. Den andra polen på den externa strömkällan ansluts till den digitala strömkretsens jordkabel (brun/blå).

**Den vita kabeln får absolut INTE komma i kontakt med den digitala strömkretsen.**

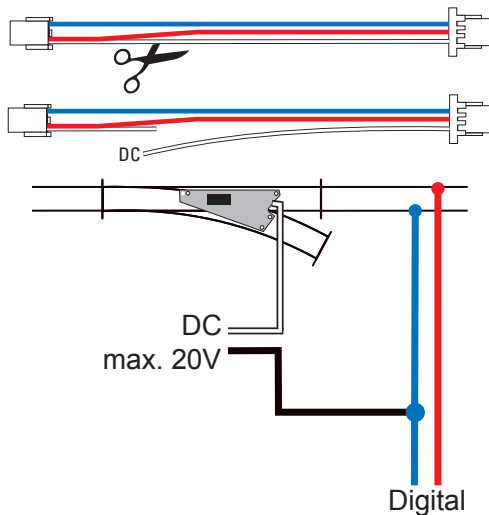

## Hensigtsmæssig anvendelse

- Den digitale indbygningsdekoder er beregnet til indbygning i Märklin- og Trix C-spor sporskifter med sporskiftestyling (undtagen Märklin trevejssporskifte).
- Den digitale indbygningsdekoder må ved ekstern strømforsyning kun tilsluttes Märklin hhv. Trix strømforsyninger.
- Må kun anvendes i tørre rum.

### Leveringsomfang

1 digital indbygningsdekoder

1 kabel gult, rødt og brunt (C-spor Märklin)

1 kabel blå, rødt og hvidt (C-spor Trix)

Montagevejledning

Garantibevis

Værktøj, som yderligere kræves til montagen: Pincet og loddeudstyr til en loddetemperatur op til maks. 30W/300° med tynd spids, elektronik-loddetin (H 0,5-1 mm), aflodningsbraid eller aflodningspumpe.

## Sikkerhedsbemærkninger

- **BEMÆRK!** Funktionsbetingede skarpe kanter og spidser.
- Udfør kun kabel- og montagearbejde uden spænding. Hvis man ikke iagttager dette, kan der forekomme farlige strømme gennem kroppen, som kan medføre kvæstelser.
- **Anvend kun dekoderen med den tilladte spænding** (se tekniske data).



I forbindelse med håndtering af loddekolben er der fare for **forbrændinger af huden.**

## Vigtige bemærkninger

- **Bemærk:** Undgå ved montagen om muligt at berøre komponenter på den digitale indbygningsdekoders overside, statisk opladning kan skade funktionen.
- Betjeningsvejledningen er en bestanddel af produktet og skal derfor gemmes samt gives med, hvis produktet gives videre.
- For reparation bedes du henvende dig til din Märklin forhandler.
- <http://www.maerklin.com/en/imprint.html>

## Tekniske data

- |                               |                |
|-------------------------------|----------------|
| • Belastning laterneudgang    | ≤ 100 mA       |
| • Belastning sporskifteudgang | max. 2 A       |
| • Spænding digitalkredsløb    | max. 20 V eff. |
| • Spænding ekstern            | max. 20 V DC   |
| • Spændingssikring            | max. 40 V      |

## Funktioner

- Multiprotokoldygtig: fx (MM) og DCC
- Indstilling af driftsart via DIP-kontakt
- Indstillelige adresser med DIP-kontakt:  
**1-256** fx (MM) (Control Unit 6021/Mobile Station 60651/652)  
**1-320** fx (MM) (Central Station 6021x/Mobile Station 60653)  
**1-511** (DCC)
- Programmerbare adresser via CV  
**1-2.044** DCC
- Ændringer af egenskaberne via CV
- Digitalsignal: Overførsel uafhængig af strømforsyningen
- Strømforsyning via digitalkredsløb
- Alternativ strømforsyning
- Loddepads til tilslutning af sporskiftelaterne
- Sporskiftelaterne kan tændes og slukkes



## Indbygning af dekoder

De følgende arbejds­skridt må kun foretages uden elektrisk spænding.

- Stik det medleverede kabel (vær opmærksom på det rigtige sporsystem) i det forberedte stik, se side 36/37 (Märklin og Trix). Følg nu den illustrerede vejledning.

Til ændring af de andre egenskaber i fx (MM) protokollen via CV programmering eller til DCC CV-programmering følg kapitlet "CV programmering."

**Bemærk venligst:** Foretag altid indstillinger med DIP-kontakten uden elektrisk spænding. Den digitale indbygningsdekoder genkender først de gældende indstillinger, når der tændes for spændingen.

Fra side 39 finder du tabellen til adressering med DIP-kontakten.

Indbygning af den digitale indbygningsdekoder i Märklin standard-, bue- eller dobbeltkrydsporskifte se side 36.

Indbygning af den digitale indbygningsdekoder i Trix standard-, bue- eller dobbeltkrydsporskifte se side 37.

## Bortskaffelse



Bemærkninger om miljøbeskyttelse: Produkter, der er mærket med en overstreget affaldsspand, må ved slutningen af deres levetid ikke bortskaffes med det normale husholdningsaffald, men skal afleveres ved et indsamlingssted for genbrug af elektrisk og elektronisk udstyr. Symbolet på produktet, betjeningsvejledningen eller emballagen gør opmærksom på det. Materialerne kan genbruges jævnfør deres mærkning. Med genbrug, ophug eller andre former for udnyttelse af udtjent udstyr yder du et vigtigt bidrag til beskyttelse af miljøet. Spørg hos din kommune, hvor du finder det rigtige afleveringssted.

## Garanti

Garanti jævnfør vedlagte garantibevis.

- For reparationer bedes du venligst henvende dig til din Märklin forhandler eller til  
Gebr. Märklin & Cie. GmbH  
Reparaturservice  
Stuttgarter Str. 55 - 57  
73033 Göppingen  
Tyskland  
Tel: +49 7161 608 222 (kun fra uden for Tyskland)  
E-Mail: Service@maerklin.de

## CV programmering

CV programmeringen skal foregå på programmeringsspoet. Til programmeringen anbefaler vi at oprette et fiktivt lokomotiv. Værdier i parentes er fabriksindstillingerne.

### fx (MM)

Før programmeringen skal det sporskifte, der skal programmeres, omskiftes fra keyboardet. Derefter skal CV omgående ændres med Control Unit hhv. Central Stations CV konfiguration. Derefter skal det programmerede sporskifte straks igen omskiftes fra keyboardet. Først nu er programmeringen overtaget og i effekt.

CV	Betydning	Værdier	
8	Dekoder-reset	8 (-)	Fabriksindstilling, værdi skrives ikke
36	Sporskiftelaterne sluk/tænd	0-1 (1)	

Fremgangsmåden ved programmering med Central Unit 6021 svarer til lokomotivprogrammeringen ([www.maerklin.de](http://www.maerklin.de) -> Tools & Downloads -> Technische Informationen).

## DCC

CV	Betydning	Værdier	
1	Adresse, lavværdi byte	0-255 (1)	
7	Producent versionsnummer (softwareversion)	(-)	kun læse
8	Producent mærkning ID dekode reset	(131) 8 (-)	kun læse, fabriksindstilling, værdi skrives ikke
9	Adresse, højeværdi byte	0-7 (0)	
29	Konfiguration	(192)	kun læse
	Bit 0-4 anvendes ikke	0	
	Bit 5: dekodertype	0 / 32	basis- el. udvidet tilbehørsdekoder
	Bit 6: adresseringsmetode	0 / 64	dekoder- el. udgangsadresse
	Bit 7: dekodeart	128	tilbehørsdekoder
36	Sporskiftelaterne, sluk/tænd	0-1 (1)	

### Indstilling og udregning af adresser højere end 255:

F.eks. adresse 1044 ->  $1044:256=4,078125$ . Værdien foran kommaet (4) skal indgives i CV 9. Værdien efter kommaet (0,078125) multipliceres med 256,  $0,078125 \times 256=20$ . Den udregnede værdi 20 skal indgives i CV 1.

### Alternativ strømforstyrning **Märklin:**

Forbind det gule kabel med en ekstern strømkilde. Den eksterne strømforstyrnings anden fri pol forbindes med det digitale strømlednings brune kabel.

**Den digitale indbygningsdekoders gule kabel må ikke forbindes med det digitale strømledningsløb.**

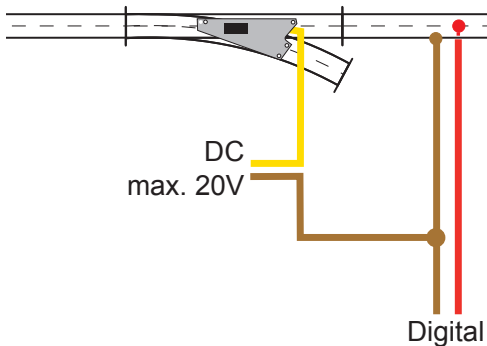

### Alternativ strømforstyrning **Trix:**

Klip det hvide kabel over og forbind det med en ekstern strømkilde. Den eksterne strømforstyrnings anden fri pol forbindes med det digitale strømlednings jordkabel (brun/blå).

**Den digitale indbygningsdekoders hvide kabel må ikke forbindes med det digitale strømledningsløb.**

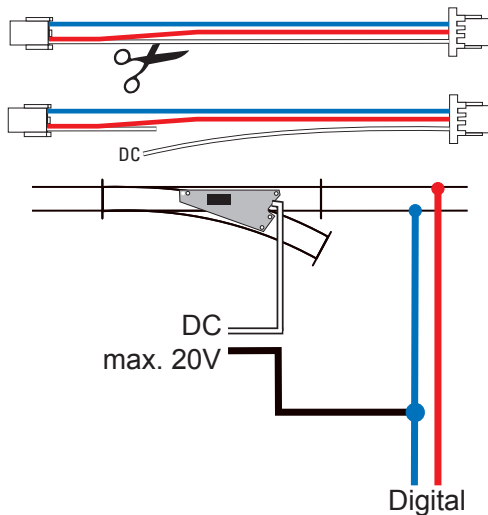

## Märklin C-Gleis / Märklin C Track / Voie C Märklin / Märklin C-rail / Via C de Märklin / Binario Märklin C / Märklin C-skenor / Märklin C-spor

- \* Gehört nicht zum Lieferumfang.
- Not included in delivery scope.
- Ne fait pas partie de la fourniture.
- Maakt geen deel uit van het leveringspakket.
- No está incluido en el conjunto de piezas suministradas.
- Non incl. nella fornitura.
- Ingår inte i leveransen.
- Medleveres ikke.

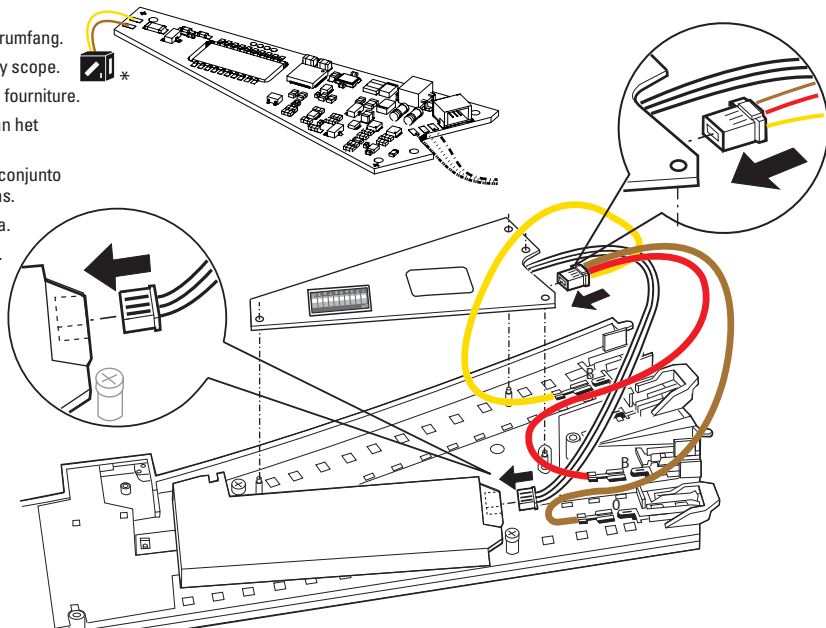

**Trix C-Gleis / Trix C Track / Voie C Trix /  
Trix C-rail / Vía C de Trix / Binario Trix C /  
Trix C-skenor / Trix C-spor**

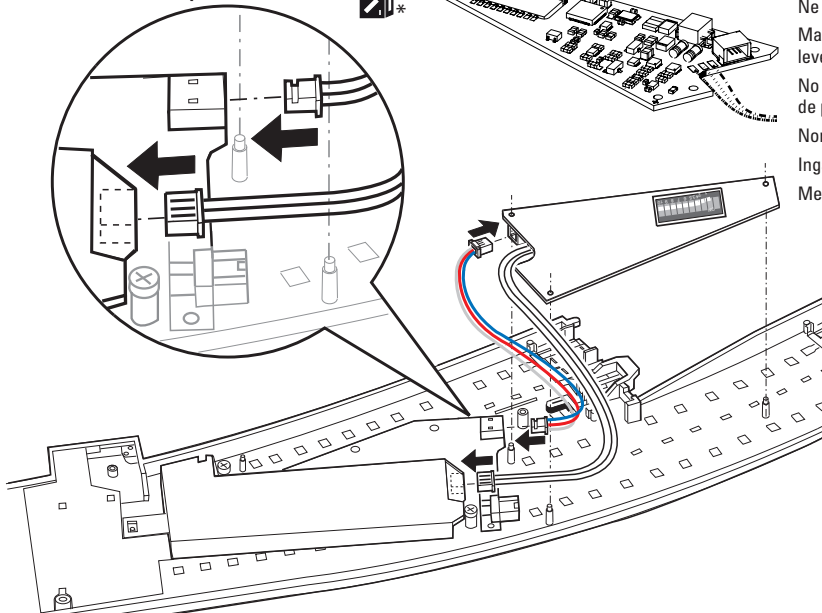

- \* Gehört nicht zum Lieferumfang.  
Not included in delivery scope.  
Ne fait pas partie de la fourniture.  
Maakt geen deel uit van het leveringspakket.  
No está incluido en el conjunto de piezas suministradas.  
Non incl. nella fornitura.  
Ingår inte i leveransen.  
Medleveres ikke.

**Betriebsart und Adressen einstellen**

**Setting the mode of operation and addresses**

**Définir le mode d'exploitation et les adresses**

**Bedrijfsmodus en adres instellen**

**Configuración de modo de funcionamiento y direcciones**

**Impostate tipo di funzionamento e indirizzi**

**Ställ in driftstyp och adress**

**Indstil driftsart og adresser**



**Adresse notieren**

**Noting the address**

**Noter l'adresse**

**Adres noteren**



**Anotar la dirección**



**Annotate gli indirizzi**

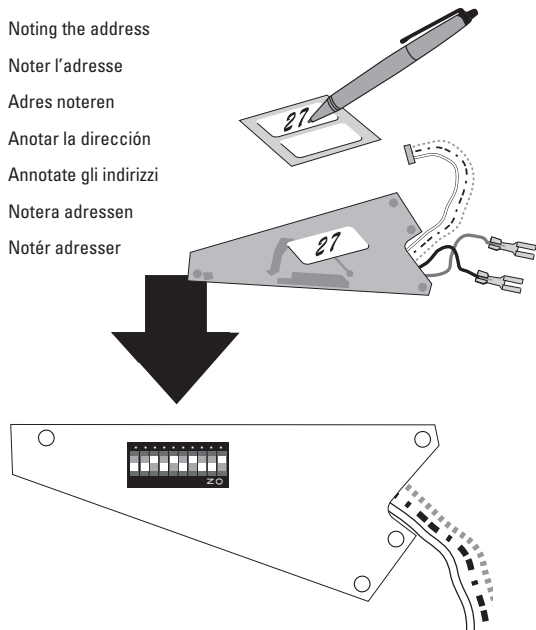

**Notera adressen**



**Notér adresser**





			10 (0/1)				
1	1 1	1					fx (MM)/DCC
2	1 2	2					fx (MM)/DCC
3	1 3	1 2					fx (MM)/DCC
4	1 4	3					fx (MM)/DCC
5	1 5	1 3					fx (MM)/DCC
6	1 6	2 3					fx (MM)/DCC
7	1 7	1 2 3					fx (MM)/DCC
8	1 8	4					fx (MM)/DCC
9	1 9	1 4					fx (MM)/DCC
10	1 10	2 4					fx (MM)/DCC
11	1 11	1 2 4					fx (MM)/DCC
12	1 12	3 4					fx (MM)/DCC
13	1 13	1 3 4					fx (MM)/DCC
14	1 14	2 3 4					fx (MM)/DCC
15	1 15	1 2 3 4					fx (MM)/DCC
16	1 16	5					fx (MM)/DCC
17	2 1	1 5					fx (MM)/DCC
18	2 2	2 5					fx (MM)/DCC
19	2 3	1 2 5					fx (MM)/DCC
20	2 4	3 5					fx (MM)/DCC
21	2 5	1 3 5					fx (MM)/DCC
22	2 6	2 3 5					fx (MM)/DCC
23	2 7	1 2 3 5					fx (MM)/DCC
24	2 8	4 5					fx (MM)/DCC
25	2 9	1 4 5					fx (MM)/DCC
26	2 10	2 4 5					fx (MM)/DCC



			10 (0/1)				
27	2 11	1 2 4 5					fx (MM)/DCC
28	2 12	3 4 5					fx (MM)/DCC
29	2 13	1 3 4 5					fx (MM)/DCC
30	2 14	2 3 4 5					fx (MM)/DCC
31	2 15	1 2 3 4 5					fx (MM)/DCC
32	2 16	6					fx (MM)/DCC
33	3 1	1 6					fx (MM)/DCC
34	3 2	2 6					fx (MM)/DCC
35	3 3	1 2 6					fx (MM)/DCC
36	3 4	3 6					fx (MM)/DCC
37	3 5	1 3 6					fx (MM)/DCC
38	3 6	2 3 6					fx (MM)/DCC
39	3 7	1 2 3 6					fx (MM)/DCC
40	3 8	4 6					fx (MM)/DCC
41	3 9	1 4 6					fx (MM)/DCC
42	3 10	2 4 6					fx (MM)/DCC
43	3 11	1 2 4 6					fx (MM)/DCC
44	3 12	3 4 6					fx (MM)/DCC
45	3 13	1 3 4 6					fx (MM)/DCC
46	3 14	2 3 4 6					fx (MM)/DCC
47	3 15	1 2 3 4 6					fx (MM)/DCC
48	3 16	5 6					fx (MM)/DCC
49	4 1	1 5 6					fx (MM)/DCC
50	4 2	2 5 6					fx (MM)/DCC
51	4 3	1 2 5 6					fx (MM)/DCC



										
			10 (0/1)							
52	4	4			3	5	6			fx (MM)/DCC
53	4	5	1		3	5	6			fx (MM)/DCC
54	4	6		2	3		5	6		fx (MM)/DCC
55	4	7	1	2	3		5	6		fx (MM)/DCC
56	4	8				4	5	6		fx (MM)/DCC
57	4	9	1			4	5	6		fx (MM)/DCC
58	4	10		2		4	5	6		fx (MM)/DCC
59	4	11	1	2			4	5	6	fx (MM)/DCC
60	4	12			3	4	5	6		fx (MM)/DCC
61	4	13	1		3	4	5	6		fx (MM)/DCC
62	4	14		2	3	4	5	6		fx (MM)/DCC
63	4	15	1	2	3	4	5	6		fx (MM)/DCC
64	4	16						7		fx (MM)/DCC
65	5	1	1					7		fx (MM)/DCC
66	5	2		2				7		fx (MM)/DCC
67	5	3	1	2				7		fx (MM)/DCC
68	5	4			3			7		fx (MM)/DCC
69	5	5	1		3			7		fx (MM)/DCC
70	5	6		2	3			7		fx (MM)/DCC
71	5	7	1	2	3			7		fx (MM)/DCC
72	5	8				4		7		fx (MM)/DCC
73	5	9	1			4		7		fx (MM)/DCC
74	5	10		2		4		7		fx (MM)/DCC
75	5	11	1	2		4		7		fx (MM)/DCC
76	5	12			3	4		7		fx (MM)/DCC



										
			10 (0/1)							
77	5	13	1		3	4		7		fx (MM)/DCC
78	5	14		2	3	4		7		fx (MM)/DCC
79	5	15	1	2	3	4		7		fx (MM)/DCC
80	5	16					5	7		fx (MM)/DCC
81	6	1	1				5	7		fx (MM)/DCC
82	6	2		2			5	7		fx (MM)/DCC
83	6	3	1	2			5	7		fx (MM)/DCC
84	6	4			3	5	7			fx (MM)/DCC
85	6	5	1		3	5	7			fx (MM)/DCC
86	6	6		2	3	5	7			fx (MM)/DCC
87	6	7	1	2	3	5	7			fx (MM)/DCC
88	6	8				4	5	7		fx (MM)/DCC
89	6	9	1			4	5	7		fx (MM)/DCC
90	6	10		2		4	5	7		fx (MM)/DCC
91	6	11	1	2		4	5	7		fx (MM)/DCC
92	6	12			3	4	5	7		fx (MM)/DCC
93	6	13	1		3	4	5	7		fx (MM)/DCC
94	6	14		2	3	4	5	7		fx (MM)/DCC
95	6	15	1	2	3	4	5	7		fx (MM)/DCC
96	6	16					6	7		fx (MM)/DCC
97	7	1	1				6	7		fx (MM)/DCC
98	7	2		2			6	7		fx (MM)/DCC
99	7	3	1	2			6	7		fx (MM)/DCC
100	7	4			3		6	7		fx (MM)/DCC
101	7	5	1	3			6	7		fx (MM)/DCC









												
			10 (0/1)									
102	7	6		2	3		6	7			fx (MM)/DCC	
103	7	7	1	2	3		6	7			fx (MM)/DCC	
104	7	8			4	6	7				fx (MM)/DCC	
105	7	9	1		4	6	7				fx (MM)/DCC	
106	7	10		2	4	6	7				fx (MM)/DCC	
107	7	11	1	2	4	6	7				fx (MM)/DCC	
108	7	12			3	4	6	7			fx (MM)/DCC	
109	7	13	1		3	4	6	7			fx (MM)/DCC	
110	7	14		2	3	4	6	7			fx (MM)/DCC	
111	7	15	1	2	3	4	6	7			fx (MM)/DCC	
112	7	16				5	6	7			fx (MM)/DCC	
113	8	1	1			5	6	7			fx (MM)/DCC	
114	8	2		2		5	6	7			fx (MM)/DCC	
115	8	3	1	2		5	6	7			fx (MM)/DCC	
116	8	4			3	5	6	7			fx (MM)/DCC	
117	8	5	1		3	5	6	7			fx (MM)/DCC	
118	8	6		2	3	5	6	7			fx (MM)/DCC	
119	8	7	1	2	3	5	6	7			fx (MM)/DCC	
120	8	8			4	5	6	7			fx (MM)/DCC	
121	8	9	1		4	5	6	7			fx (MM)/DCC	
122	8	10		2	4	5	6	7			fx (MM)/DCC	
123	8	11	1	2	4	5	6	7			fx (MM)/DCC	
124	8	12			3	4	5	6	7		fx (MM)/DCC	
125	8	13	1		3	4	5	6	7		fx (MM)/DCC	
126	8	14		2	3	4	5	6	7		fx (MM)/DCC	
127	8	15	1	2	3	4	5	6	7		fx (MM)/DCC	



												
			10 (0/1)									
128	8	16								8	fx (MM)/DCC	
129	9	1	1							8	fx (MM)/DCC	
130	9	2		2						8	fx (MM)/DCC	
131	9	3	1	2						8	fx (MM)/DCC	
132	9	4			3					8	fx (MM)/DCC	
133	9	5	1	3						8	fx (MM)/DCC	
134	9	6		2	3					8	fx (MM)/DCC	
135	9	7	1	2	3					8	fx (MM)/DCC	
136	9	8				4				8	fx (MM)/DCC	
137	9	9	1			4				8	fx (MM)/DCC	
138	9	10		2	4					8	fx (MM)/DCC	
139	9	11	1	2	4					8	fx (MM)/DCC	
140	9	12			3	4				8	fx (MM)/DCC	
141	9	13	1		3	4				8	fx (MM)/DCC	
142	9	14		2	3	4				8	fx (MM)/DCC	
143	9	15	1	2	3	4				8	fx (MM)/DCC	
144	9	16					5			8	fx (MM)/DCC	
145	10	1	1				5			8	fx (MM)/DCC	
146	10	2		2			5			8	fx (MM)/DCC	
147	10	3	1	2			5			8	fx (MM)/DCC	
148	10	4			3		5			8	fx (MM)/DCC	
149	10	5	1	3			5			8	fx (MM)/DCC	
150	10	6		2	3		5			8	fx (MM)/DCC	
151	10	7	1	2	3		5			8	fx (MM)/DCC	
152	10	8				4	5			8	fx (MM)/DCC	
153	10	9	1			4	5			8	fx (MM)/DCC	



										
			10 (0/1)							
154	10	10		2		4	5		8	fx (MM)/DCC
155	10	11	1	2		4	5		8	fx (MM)/DCC
156	10	12			3	4	5		8	fx (MM)/DCC
157	10	13	1		3	4	5		8	fx (MM)/DCC
158	10	14		2	3	4	5		8	fx (MM)/DCC
159	10	15	1	2	3	4	5		8	fx (MM)/DCC
160	10	16					6		8	fx (MM)/DCC
161	11	1	1				6		8	fx (MM)/DCC
162	11	2		2			6		8	fx (MM)/DCC
163	11	3	1	2			6		8	fx (MM)/DCC
164	11	4			3		6		8	fx (MM)/DCC
165	11	5	1		3		6		8	fx (MM)/DCC
166	11	6		2	3		6		8	fx (MM)/DCC
167	11	7	1	2	3		6		8	fx (MM)/DCC
168	11	8			4		6		8	fx (MM)/DCC
169	11	9	1		4		6		8	fx (MM)/DCC
170	11	10		2		4	6		8	fx (MM)/DCC
171	11	11	1	2		4	6		8	fx (MM)/DCC
172	11	12			3	4	6		8	fx (MM)/DCC
173	11	13	1		3	4	6		8	fx (MM)/DCC
174	11	14		2	3	4	6		8	fx (MM)/DCC
175	11	15	1	2	3	4	6		8	fx (MM)/DCC
176	11	16				5	6		8	fx (MM)/DCC
177	12	1	1			5	6		8	fx (MM)/DCC
178	12	2		2		5	6		8	fx (MM)/DCC
179	12	3	1	2		5	6		8	fx (MM)/DCC



										
			10 (0/1)							
180	12	4			3		5	6	8	fx (MM)/DCC
181	12	5	1		3		5	6	8	fx (MM)/DCC
182	12	6		2	3		5	6	8	fx (MM)/DCC
183	12	7	1	2	3		5	6	8	fx (MM)/DCC
184	12	8				4	5	6	8	fx (MM)/DCC
185	12	9	1			4	5	6	8	fx (MM)/DCC
186	12	10		2		4	5	6	8	fx (MM)/DCC
187	12	11	1	2		4	5	6	8	fx (MM)/DCC
188	12	12			3	4	5	6	8	fx (MM)/DCC
189	12	13	1		3	4	5	6	8	fx (MM)/DCC
190	12	14		2	3	4	5	6	8	fx (MM)/DCC
191	12	15	1	2	3	4	5	6	8	fx (MM)/DCC
192	12	16					7	8		fx (MM)/DCC
193	13	1	1				7	8		fx (MM)/DCC
194	13	2		2			7	8		fx (MM)/DCC
195	13	3	1	2			7	8		fx (MM)/DCC
196	13	4			3		7	8		fx (MM)/DCC
197	13	5	1		3		7	8		fx (MM)/DCC
198	13	6		2	3		7	8		fx (MM)/DCC
199	13	7	1	2	3		7	8		fx (MM)/DCC
200	13	8				4	7	8		fx (MM)/DCC
201	13	9	1			4	7	8		fx (MM)/DCC
202	13	10		2		4	7	8		fx (MM)/DCC
203	13	11	1	2		4	7	8		fx (MM)/DCC
204	13	12			3	4	7	8		fx (MM)/DCC
205	13	13	1		3	4	7	8		fx (MM)/DCC



													10 (0/1)
206		13 14		2 3 4		7 8	fx (MM)/DCC						
207		13 15	1	2 3 4		7 8	fx (MM)/DCC						
208		13 16			5	7 8	fx (MM)/DCC						
209		14 1	1		5	7 8	fx (MM)/DCC						
210		14 2		2		5 7 8	fx (MM)/DCC						
211		14 3	1 2		5	7 8	fx (MM)/DCC						
212		14 4			3	5 7 8	fx (MM)/DCC						
213		14 5	1		3	5 7 8	fx (MM)/DCC						
214		14 6		2 3		5 7 8	fx (MM)/DCC						
215		14 7	1 2 3		5	7 8	fx (MM)/DCC						
216		14 8			4 5	7 8	fx (MM)/DCC						
217		14 9	1		4 5	7 8	fx (MM)/DCC						
218		14 10		2		4 5 7 8	fx (MM)/DCC						
219		14 11	1 2		4 5	7 8	fx (MM)/DCC						
220		14 12			3 4 5	7 8	fx (MM)/DCC						
221		14 13	1		3 4 5	7 8	fx (MM)/DCC						
222		14 14		2 3 4 5		7 8	fx (MM)/DCC						
223		14 15	1 2 3 4 5		7 8	fx (MM)/DCC							
224		14 16				6 7 8	fx (MM)/DCC						
225		15 1	1			6 7 8	fx (MM)/DCC						
226		15 2		2		6 7 8	fx (MM)/DCC						
227		15 3	1 2			6 7 8	fx (MM)/DCC						
228		15 4			3	6 7 8	fx (MM)/DCC						
229		15 5	1		3	6 7 8	fx (MM)/DCC						
230		15 6		2 3		6 7 8	fx (MM)/DCC						
231		15 7	1 2 3			6 7 8	fx (MM)/DCC						



													10 (0/1)
232		15 8			4	6 7 8	fx (MM)/DCC						
233		15 9	1		4	6 7 8	fx (MM)/DCC						
234		15 10		2	4	6 7 8	fx (MM)/DCC						
235		15 11	1 2		4	6 7 8	fx (MM)/DCC						
236		15 12			3 4	6 7 8	fx (MM)/DCC						
237		15 13	1		3 4	6 7 8	fx (MM)/DCC						
238		15 14		2 3 4		6 7 8	fx (MM)/DCC						
239		15 15	1 2 3 4			6 7 8	fx (MM)/DCC						
240		15 16				5 6 7 8	fx (MM)/DCC						
241		16 1	1			5 6 7 8	fx (MM)/DCC						
242		16 2		2		5 6 7 8	fx (MM)/DCC						
243		16 3	1 2			5 6 7 8	fx (MM)/DCC						
244		16 4			3	5 6 7 8	fx (MM)/DCC						
245		16 5	1		3	5 6 7 8	fx (MM)/DCC						
246		16 6		2 3		5 6 7 8	fx (MM)/DCC						
247		16 7	1 2 3			5 6 7 8	fx (MM)/DCC						
248		16 8			4 5 6 7 8	fx (MM)/DCC							
249		16 9	1		4 5 6 7 8	fx (MM)/DCC							
250		16 10		2		4 5 6 7 8	fx (MM)/DCC						
251		16 11	1 2			4 5 6 7 8	fx (MM)/DCC						
252		16 12			3 4 5 6 7 8	fx (MM)/DCC							
253		16 13	1		3 4 5 6 7 8	fx (MM)/DCC							
254		16 14		2 3 4 5 6 7 8		fx (MM)/DCC							
255		16 15	1 2 3 4 5 6 7 8			fx (MM)/DCC							
256		16 16				9	fx (MM)/DCC						
257		17 1	1			9	fx (MM)/DCC						



													
			10 (0/1)										
258	17	2		2								9	fx (MM)/DCC
259	17	3	1	2								9	fx (MM)/DCC
260	17	4			3							9	fx (MM)/DCC
261	17	5	1		3							9	fx (MM)/DCC
262	17	6		2	3							9	fx (MM)/DCC
263	17	7	1	2	3							9	fx (MM)/DCC
264	17	8				4						9	fx (MM)/DCC
265	17	9	1			4						9	fx (MM)/DCC
266	17	10		2		4						9	fx (MM)/DCC
267	17	11	1	2		4						9	fx (MM)/DCC
268	17	12			3	4						9	fx (MM)/DCC
269	17	13	1		3	4						9	fx (MM)/DCC
270	17	14		2	3	4						9	fx (MM)/DCC
271	17	15	1	2	3	4						9	fx (MM)/DCC
272	17	16					5					9	fx (MM)/DCC
273	18	1	1				5					9	fx (MM)/DCC
274	18	2		2			5					9	fx (MM)/DCC
275	18	3	1	2			5					9	fx (MM)/DCC
276	18	4			3		5					9	fx (MM)/DCC
277	18	5	1		3		5					9	fx (MM)/DCC
278	18	6		2	3		5					9	fx (MM)/DCC
279	18	7	1	2	3		5					9	fx (MM)/DCC
280	18	8				4	5					9	fx (MM)/DCC
281	18	9	1			4	5					9	fx (MM)/DCC
282	18	10		2		4	5					9	fx (MM)/DCC
283	18	11	1	2		4	5					9	fx (MM)/DCC



													
			10 (0/1)										
284	18	12			3	4	5					9	fx (MM)/DCC
285	18	13	1		3	4	5					9	fx (MM)/DCC
286	18	14		2	3	4	5					9	fx (MM)/DCC
287	18	15	1	2	3	4	5					9	fx (MM)/DCC
288	18	16						6				9	fx (MM)/DCC
289	19	1	1					6				9	fx (MM)/DCC
290	19	2		2				6				9	fx (MM)/DCC
291	19	3	1	2				6				9	fx (MM)/DCC
292	19	4			3			6				9	fx (MM)/DCC
293	19	5	1		3			6				9	fx (MM)/DCC
294	19	6		2	3			6				9	fx (MM)/DCC
295	19	7	1	2	3			6				9	fx (MM)/DCC
296	19	8				4		6				9	fx (MM)/DCC
297	19	9	1			4		6				9	fx (MM)/DCC
298	19	10		2		4		6				9	fx (MM)/DCC
299	19	11	1	2		4		6				9	fx (MM)/DCC
300	19	12			3	4		6				9	fx (MM)/DCC
301	19	13	1		3	4		6				9	fx (MM)/DCC
302	19	14		2	3	4		6				9	fx (MM)/DCC
303	19	15	1	2	3	4		6				9	fx (MM)/DCC
304	19	16					5	6				9	fx (MM)/DCC
305	20	1	1				5	6				9	fx (MM)/DCC
306	20	2		2			5	6				9	fx (MM)/DCC
307	20	3	1	2			5	6				9	fx (MM)/DCC
308	20	4			3		5	6				9	fx (MM)/DCC
309	20	5	1		3		5	6				9	fx (MM)/DCC



												
			10 (0/1)									
310	20	6		2	3		5	6		9	fx (MM)/DCC	
311	20	7	1	2	3		5	6		9	fx (MM)/DCC	
312	20	8				4	5	6		9	fx (MM)/DCC	
313	20	9	1			4	5	6		9	fx (MM)/DCC	
314	20	10		2		4	5	6		9	fx (MM)/DCC	
315	20	11	1	2		4	5	6		9	fx (MM)/DCC	
316	20	12			3	4	5	6		9	fx (MM)/DCC	
317	20	13	1		3	4	5	6		9	fx (MM)/DCC	
318	20	14		2	3	4	5	6		9	fx (MM)/DCC	
319	20	15	1	2	3	4	5	6		9	fx (MM)/DCC	
320	20	16						7		9	fx (MM)/DCC	
321	21	1	1					7		9	---/DCC	
322	21	2		2				7		9	---/DCC	
323	21	3	1	2				7		9	---/DCC	
324	21	4			3			7		9	---/DCC	
325	21	5	1		3			7		9	---/DCC	
326	21	6		2	3			7		9	---/DCC	
327	21	7	1	2	3			7		9	---/DCC	
328	21	8				4		7		9	---/DCC	
329	21	9	1			4		7		9	---/DCC	
330	21	10		2		4		7		9	---/DCC	
331	21	11	1	2		4		7		9	---/DCC	
332	21	12			3	4		7		9	---/DCC	
333	21	13	1		3	4		7		9	---/DCC	
334	21	14		2	3	4		7		9	---/DCC	
335	21	15	1	2	3	4		7		9	---/DCC	



												
			10 (0/1)									
336	21	16						5		7	9	---/DCC
337	22	1	1					5		7	9	---/DCC
338	22	2		2				5		7	9	---/DCC
339	22	3	1	2				5		7	9	---/DCC
340	22	4			3			5		7	9	---/DCC
341	22	5	1		3			5		7	9	---/DCC
342	22	6		2	3			5		7	9	---/DCC
343	22	7	1	2	3			5		7	9	---/DCC
344	22	8				4	5			7	9	---/DCC
345	22	9	1			4	5			7	9	---/DCC
346	22	10		2		4	5			7	9	---/DCC
347	22	11	1	2		4	5			7	9	---/DCC
348	22	12			3	4	5			7	9	---/DCC
349	22	13	1		3	4	5			7	9	---/DCC
350	22	14		2	3	4	5			7	9	---/DCC
351	22	15	1	2	3	4	5			7	9	---/DCC
352	22	16						6		7	9	---/DCC
353	23	1	1					6		7	9	---/DCC
354	23	2		2				6		7	9	---/DCC
355	23	3	1	2				6		7	9	---/DCC
356	23	4			3			6		7	9	---/DCC
357	23	5	1		3			6		7	9	---/DCC
358	23	6		2	3			6		7	9	---/DCC
359	23	7	1	2	3			6		7	9	---/DCC
360	23	8				4		6		7	9	---/DCC
361	23	9	1			4		6		7	9	---/DCC



										10 (0/1)		
362	23	10		2	4	6	7	9	---	/DCC		
363	23	11	1	2	4	6	7	9	---	/DCC		
364	23	12			3	4	6	7	9	---	/DCC	
365	23	13	1		3	4	6	7	9	---	/DCC	
366	23	14		2	3	4	6	7	9	---	/DCC	
367	23	15	1	2	3	4	6	7	9	---	/DCC	
368	23	16				5	6	7	9	---	/DCC	
369	24	1	1			5	6	7	9	---	/DCC	
370	24	2		2		5	6	7	9	---	/DCC	
371	24	3	1	2		5	6	7	9	---	/DCC	
372	24	4			3	5	6	7	9	---	/DCC	
373	24	5	1		3	5	6	7	9	---	/DCC	
374	24	6		2	3	5	6	7	9	---	/DCC	
375	24	7	1	2	3	5	6	7	9	---	/DCC	
376	24	8			4	5	6	7	9	---	/DCC	
377	24	9	1		4	5	6	7	9	---	/DCC	
378	24	10		2	4	5	6	7	9	---	/DCC	
379	24	11	1	2	4	5	6	7	9	---	/DCC	
380	24	12			3	4	5	6	7	9	---	/DCC
381	24	13	1		3	4	5	6	7	9	---	/DCC
382	24	14		2	3	4	5	6	7	9	---	/DCC
383	24	15	1	2	3	4	5	6	7	9	---	/DCC
384	24	16						8	9	---	/DCC	
385	25	1	1					8	9	---	/DCC	
386	25	2		2				8	9	---	/DCC	
387	25	3	1	2				8	9	---	/DCC	

										10 (0/1)				
388	25	4						3			8	9	---	/DCC
389	25	5	1					3			8	9	---	/DCC
390	25	6			2	3					8	9	---	/DCC
391	25	7	1	2	3						8	9	---	/DCC
392	25	8							4		8	9	---	/DCC
393	25	9	1						4		8	9	---	/DCC
394	25	10			2	4					8	9	---	/DCC
395	25	11	1	2		4					8	9	---	/DCC
396	25	12			3	4					8	9	---	/DCC
397	25	13	1		3	4					8	9	---	/DCC
398	25	14			2	3	4				8	9	---	/DCC
399	25	15	1	2	3	4					8	9	---	/DCC
400	25	16							5		8	9	---	/DCC
401	26	1	1						5		8	9	---	/DCC
402	26	2		2					5		8	9	---	/DCC
403	26	3	1	2					5		8	9	---	/DCC
404	26	4			3	5					8	9	---	/DCC
405	26	5	1		3	5					8	9	---	/DCC
406	26	6			2	3	5				8	9	---	/DCC
407	26	7	1	2	3		5				8	9	---	/DCC
408	26	8					4	5			8	9	---	/DCC
409	26	9	1				4	5			8	9	---	/DCC
410	26	10			2	4	5				8	9	---	/DCC
411	26	11	1	2		4	5				8	9	---	/DCC
412	26	12			3	4	5				8	9	---	/DCC
413	26	13	1		3	4	5				8	9	---	/DCC

													10 (0/1)	
414	26	14		2	3	4	5		8	9			---	/DCC
415	26	15	1	2	3	4	5		8	9			---	/DCC
416	26	16					6		8	9			---	/DCC
417	27	1	1				6		8	9			---	/DCC
418	27	2		2			6		8	9			---	/DCC
419	27	3	1	2			6		8	9			---	/DCC
420	27	4			3		6		8	9			---	/DCC
421	27	5	1		3		6		8	9			---	/DCC
422	27	6		2	3		6		8	9			---	/DCC
423	27	7	1	2	3		6		8	9			---	/DCC
424	27	8			4		6		8	9			---	/DCC
425	27	9	1		4		6		8	9			---	/DCC
426	27	10		2	4		6		8	9			---	/DCC
427	27	11	1	2		4		6		8	9		---	/DCC
428	27	12			3	4		6		8	9		---	/DCC
429	27	13	1		3	4		6		8	9		---	/DCC
430	27	14		2	3	4		6		8	9		---	/DCC
431	27	15	1	2	3	4		6		8	9		---	/DCC
432	27	16				5	6		8	9			---	/DCC
433	28	1	1			5	6		8	9			---	/DCC
434	28	2		2		5	6		8	9			---	/DCC
435	28	3	1	2		5	6		8	9			---	/DCC
436	28	4			3	5	6		8	9			---	/DCC
437	28	5	1		3	5	6		8	9			---	/DCC
438	28	6		2	3	5	6		8	9			---	/DCC
439	28	7	1	2	3	5	6		8	9			---	/DCC

													10 (0/1)	
440	28	8				4	5	6		8	9		---	/DCC
441	28	9	1			4	5	6		8	9		---	/DCC
442	28	10		2		4	5	6		8	9		---	/DCC
443	28	11	1	2		4	5	6		8	9		---	/DCC
444	28	12			3	4	5	6		8	9		---	/DCC
445	28	13	1		3	4	5	6		8	9		---	/DCC
446	28	14		2	3	4	5	6		8	9		---	/DCC
447	28	15	1	2	3	4	5	6		8	9		---	/DCC
448	28	16						7		8	9		---	/DCC
449	29	1	1					7		8	9		---	/DCC
450	29	2		2				7		8	9		---	/DCC
451	29	3	1	2				7		8	9		---	/DCC
452	29	4			3			7		8	9		---	/DCC
453	29	5	1		3			7		8	9		---	/DCC
454	29	6		2	3			7		8	9		---	/DCC
455	29	7	1	2	3			7		8	9		---	/DCC
456	29	8				4		7		8	9		---	/DCC
457	29	9	1			4		7		8	9		---	/DCC
458	29	10		2		4		7		8	9		---	/DCC
459	29	11	1	2		4		7		8	9		---	/DCC
460	29	12			3	4		7		8	9		---	/DCC
461	29	13	1		3	4		7		8	9		---	/DCC
462	29	14		2	3	4		7		8	9		---	/DCC
463	29	15	1	2	3	4		7		8	9		---	/DCC
464	29	16					5		7	8	9		---	/DCC
465	30	1	1				5		7	8	9		---	/DCC

											
			10 (0/1)								
466	30	2		2		5	7	8	9	---/DCC	
467	30	3	1	2		5	7	8	9	---/DCC	
468	30	4			3	5	7	8	9	---/DCC	
469	30	5	1		3	5	7	8	9	---/DCC	
470	30	6		2	3	5	7	8	9	---/DCC	
471	30	7	1	2	3	5	7	8	9	---/DCC	
472	30	8				4	5	7	8	9	---/DCC
473	30	9	1			4	5	7	8	9	---/DCC
474	30	10		2		4	5	7	8	9	---/DCC
475	30	11	1	2		4	5	7	8	9	---/DCC
476	30	12			3	4	5	7	8	9	---/DCC
477	30	13	1		3	4	5	7	8	9	---/DCC
478	30	14		2	3	4	5	7	8	9	---/DCC
479	30	15	1	2	3	4	5	7	8	9	---/DCC
480	30	16					6	7	8	9	---/DCC
481	31	1	1				6	7	8	9	---/DCC
482	31	2		2			6	7	8	9	---/DCC
483	31	3	1	2			6	7	8	9	---/DCC
484	31	4			3		6	7	8	9	---/DCC
485	31	5	1		3		6	7	8	9	---/DCC
486	31	6		2	3		6	7	8	9	---/DCC
487	31	7	1	2	3		6	7	8	9	---/DCC
488	31	8				4	6	7	8	9	---/DCC
489	31	9	1			4	6	7	8	9	---/DCC
490	31	10		2		4	6	7	8	9	---/DCC
491	31	11	1	2		4	6	7	8	9	---/DCC

													
			10 (0/1)										
492	31	12			3	4		6	7	8	9	---/DCC	
493	31	13	1		3	4		6	7	8	9	---/DCC	
494	31	14		2	3	4		6	7	8	9	---/DCC	
495	31	15	1	2	3	4		6	7	8	9	---/DCC	
496	31	16						5	6	7	8	9	---/DCC
497	32	1	1					5	6	7	8	9	---/DCC
498	32	2		2				5	6	7	8	9	---/DCC
499	32	3	1	2				5	6	7	8	9	---/DCC
500	32	4			3			5	6	7	8	9	---/DCC
501	32	5	1		3			5	6	7	8	9	---/DCC
502	32	6		2	3			5	6	7	8	9	---/DCC
503	32	7	1	2	3			5	6	7	8	9	---/DCC
504	32	8				4	5	6	7	8	9	---/DCC	
505	32	9	1			4	5	6	7	8	9	---/DCC	
506	32	10		2		4	5	6	7	8	9	---/DCC	
507	32	11	1	2		4	5	6	7	8	9	---/DCC	
508	32	12			3	4	5	6	7	8	9	---/DCC	
509	32	13	1		3	4	5	6	7	8	9	---/DCC	
510	32	14		2	3	4	5	6	7	8	9	---/DCC	
511	32	15	1	2	3	4	5	6	7	8	9	---/DCC	

Adressen größer 511 können nur im DCC Format ausgegeben werden und müssen mit der CV Programmierung über das Programmiergleis durchgeführt werden.



Addresses larger than 511 can only be assigned in the DCC format and must be done by programming a CV using the programming track.

Les adresses supérieures à 511 peuvent uniquement être éditées dans le format DCC et doivent être exécutées avec la programmation des CV via la voie de programmation.

Adressen groter dan 511 kunnen alleen in het DCC formaat gebruikt worden en moeten met de CV programmering via het programmeerspoor ingesteld worden.

Las direcciones superiores a 511 pueden mostrarse en el formato DCC y deben configurarse con la función Programación de CVs mediante la vía de programación.

Indirizzi maggiori di 511 possono essere assegnati solo nel formato DCC e si devono eseguire con la programmazione delle CV tramite il binario di programmazione.

Adresser överstigande 511 kan endast skrivas in i DCC-format och måste göras med CV-programmering med loket på programmeringspåret.

Adresser højere end 511 kan kun udtrykkes i DCC format og skal udføres med CV programmeringen via programmeringsporet.





Gebr. Märklin & Cie. GmbH  
Stuttgarter Straße 55 - 57  
73033 Göppingen  
Germany  
[www.maerklin.com](http://www.maerklin.com)



[www.maerklin.com/en/imprint.html](http://www.maerklin.com/en/imprint.html)

184974/0113/Ha3Be  
Änderungen vorbehalten  
© Gebr. Märklin & Cie. GmbH