

SCT-D-SUB 9-KG

Obj.č.: 2749550



<http://eshop.phoenixcontact.cz/phoenix/treeViewClick.do?UID=2749550>

Kryt kabelu POWER-SUBCON, 3pólový

Údaje

EAN	 4 017918 104979
Balení	1 ks
Celní tarif	85389099
Váha brutto v kusech	0,0457 kg
Informace v katalogu	Strana 214 (CC-2005)

Poznámky k produktu

WEEE/RoHS-compliant since:
01.01.2004



<http://www.download.phoenixcontact.com>
Please note that the data given here has been taken from the online catalog. For comprehensive information and data, please refer to the user documentation. The General Terms and Conditions of Use apply to Internet downloads.

Certifikáty/Osvědčení

Aprobace

Vyžádané aprobace:

Aprobace z:

Výkres/schéma

Výkres v měřítku

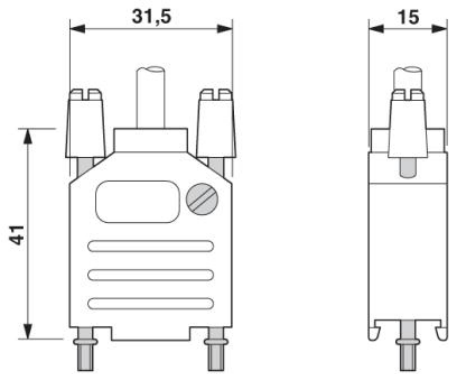

Adresa

PHOENIX CONTACT, s.r.o.
Dornych 47
617 00 Brno, Czech Republic
Telefon +420 542 213 401
Fax +420 542 213 701
<http://www.phoenixcontact.cz>



© 2013 Phoenix Contact
Technické změny vyhrazeny.