

PB-DP SUB-D ZF TERM PS**Weidmüller Interface GmbH & Co. KG**

Klingenbergstraße 16

D-32758 Detmold

Germany

Fon: +49 5231 14-0

Fax: +49 5231 14-292083

www.weidmueller.com



V dnešní době jsou často potřeba individuální délky kabelů. K uspokojení těchto požadavků nabízí společnost Weidmüller širokou řadu zásuvných konektorů pro vlastní montáž.

Všeobecné objednací údaje

Typ	PB-DP SUB-D ZF TERM PS
Objednací číslo	1161880000
Verze	
GTIN (EAN)	4032248950843
Mnž.	1 ks

PB-DP SUB-D ZF TERM PS

Weidmüller Interface GmbH & Co. KG
 Klingenbergstraße 16
 D-32758 Detmold
 Germany
 Fon: +49 5231 14-0
 Fax: +49 5231 14-292083
 www.weidmueller.com

Technické údaje

Rozměry a váhy

Čistá hmotnost 90 g

Teploty

Vlhkost Max. 75% při +25°C, bez kondensace

Shoda produktu s prostředím

REACH SVHC Lead 7439-92-1

Technické specifikace konektoru sub-D

BUS PG rozhraní	D-Sub 9-pólový, Patice	BUS rozhraní	D-Sub 9-pólový, Kontakt
BUS, kabelové rozhraní	Připojení s kotevní svorkou	Cykly zapojování	≥ 200
Hlavní materiál krytu	ZnAl	Rozsah teplot krytu	-20...+70 ° C
Rychlost přenosu dat	12 MBit/s	Stupeň krytí	IP30
Ukončovací rezistor k dispozici	Ano	Vlhkost	Max. 75% při +25°C, bez kondensace
Vzájemné blokování	UNC4-40	Výstupní tvarovka	90°
Zasouvací konektor a přiřazení kontaktů	V souladu se specifikací PROFIBUS		

Klasifikace

ETIM 4.0	EC002640	ETIM 5.0	EC002640
ETIM 6.0	EC001132	eClass 6.2	27-26-07-07
eClass 7.1	27-44-03-07	eClass 8.1	27-44-03-07
eClass 9,1	27-44-03-90	eClass 9.0	27-44-03-02

Osvědčení

ROHS Shoda

Soubory ke stažení

Brožura/Katalog [CAT 8 SAI 15/16 EN](#)
[FL FIELDWIRING EN](#)

PB-DP SUB-D ZF TERM PS

Weidmüller Interface GmbH & Co. KG
 Klängenbergstraße 16
 D-32758 Detmold
 Germany
 Fon: +49 5231 14-0
 Fax: +49 5231 14-292083
 www.weidmueller.com

Nákresy

Schéma připojení

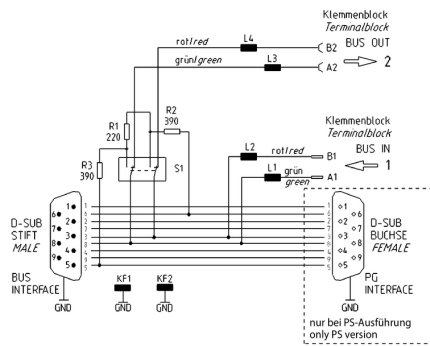

Montageanleitung: PROFIBUS Bus-Stecker mit interner Kabelklemme



Eingang 1 und Ausgang 2	
L	(30)
L1	24
L2	7
L3	6

Art.-Nr.	Beschreibung	Abmessungen Busstecker
2433510000	PB-DP SUB-D ZF 180 TERM	62 x 31,6 x 14,8 mm



Eingang 1		Ausgang 2	
L	(30)	L	(35)
L1	24	L1	29
L2	7	L2	7
L3	6	L3	6

Art.-Nr.	Beschreibung	Abmessungen Busstecker
1173220000	PB-DP SUB-D ZF 35 TERM	64,6 x 42 x 16,8 mm
1173240000	PB-DP SUB-D ZF 35 TERM PS	64,6 x 42 x 16,8 mm

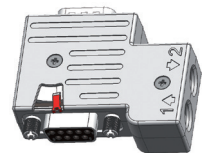

Eingang 1		Ausgang 2	
L	(35)	L	(30)
L1	29	L1	24
L2	7	L2	7
L3	6	L3	6

Art.-Nr.	Beschreibung	Abmessungen Busstecker
1161870000	PB-DP SUB-D ZF TERM	53,6 x 42 x 16,8 mm
1161880000	PB-DP SUB-D ZF T PS	53,6 x 42 x 16,8 mm

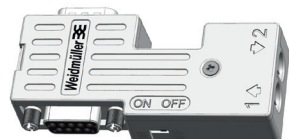

Eingang 1 und Ausgang 2	
L	(30)
L1	24
L2	7
L3	6

Art.-Nr.	Beschreibung	Abmessungen Busstecker
2004310000	PB-DP SUB-D ZF TERM S7	77,7 x 34,7 x 16,8 mm
2004320000	PB-DP SUB-D ZF T PS S7	77,7 x 34,7 x 16,8 mm

Schaltbild



Bus-Terminierung



Diese Produkte sind für den Einsatz an Betriebsarten gemäß (National Electric Code) NFPA 79, bis Verschmutzungsgrad 2 zugelassen.

(Dargestellt 1173240000)



Die Befestigungsschrauben lösen
mit Pozidriv-Schraubendreher PZ1

Busstecker in geöffnetem Zustand
ohne Gehäuse-Deckel und ohne Schirmbügel.

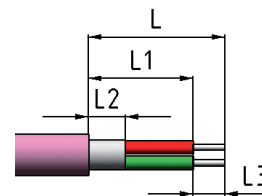
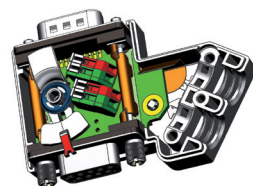

Profibus-Kabelmantel gestuft abisolieren

(siehe Artikel)
in einem Step mit mehrstufigen Abisolierwerkzeug (empfohlen Weidmüller CST vario) oder in mehreren Steps mit Standard-Abisolierwerkzeuge. Einzeladern abisolieren mit Abisolierzange (empfohlen Weidmüller STRIPAX).



Käfigzugfeder-Klemmen öffnen

Schraubendreher mit Klinge 2,5 x 0,4 in weiße Betätigungsschieber einführen und nach vorne schieben (Pfeil 1) in Richtung Kabelausgang.



Abisolierte Einzeladern für ankommendes Profibus-Kabel
jeweils in die Klemmen A1 und B1 einführen (Pfeil 2) und Käfigzugfederklemmen schließen (Pfeil 3).

Abisolierte Einzeladern für abgehendes Profibus-Kabel
jeweils in die Klemmen A2 und B2 einführen (Pfeil 2) und Käfigzugfederklemmen schließen (Pfeil 3).

Achtung! bei SPECIAL und COMPACT
Der Schalter für den Abschlusswiderstand darf nur betätigt werden solange der D-Sub Stecker nicht schraubverriegelt ist.

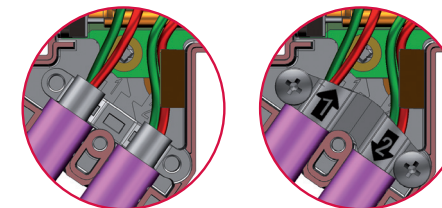

Schirmbügel anziehen

Darauf achten, dass Kabelschirm flächig auf vorderer Kabelschirmauflage aufliegt (siehe linkes Bild). Die Befestigungsschrauben anziehen mit Pozidriv-Schraubendreher PZ1.
Anzugsmoment: max. 0,3 Nm.

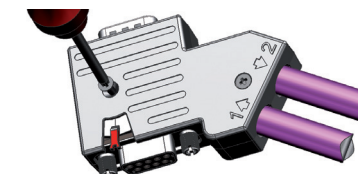

Gehäusedeckel verriegeln

Die Befestigungsschrauben anziehen mit Pozidriv-Schraubendreher PZ1
Anzugsmoment: max. 0,3 Nm.



Bus-Terminierung (Abschlusswiderstände) Aus/Ein

Den Schalterhebel beim Busabschluss für aktive Terminierung in die Position „ON“ stellen. Für den eingangsseitigen Busabschluss beim 1. Teilnehmer, das abgehende Bus-Kabel auf der Eingangsseite (1) anschließen und den Schalterhebel in Position „ON“ stellen.

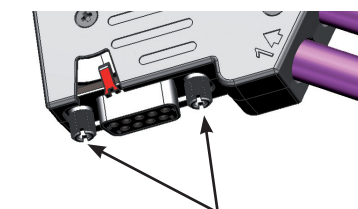

Befestigung am D-Sub der Profibus-Schnittstelle
Anzugsmoment der Rändel-Verriegelungsschraube: max. 0,3 Nm.

Mounting Instruction: PROFIBUS Bus Connectors with internal cable clamp

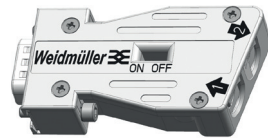

Input 1 and Outout 2	
L	(30)
L1	24
L2	7
L3	6

Part No.	Description	Dimensions Bus Connector
2433510000	PB-DP SUB-D ZF 180 TERM	62 x 31,6 x 14,8 mm

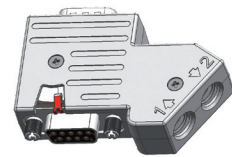

Input 1		Outout 2	
L	(30)	L	(35)
L1	24	L1	29
L2	7	L2	7
L3	6	L3	6

Part No.	Description	Dimensions Bus Connector
1173220000	PB-DP SUB-D ZF 35 TERM	64,6 x 42 x 16,8 mm
1173240000	PB-DP SUB-D ZF 35 TERM PS	64,6 x 42 x 16,8 mm

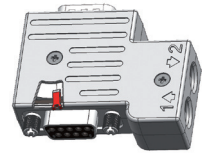

Input 1		Outout 2	
L	(35)	L	(30)
L1	29	L1	24
L2	7	L2	7
L3	6	L3	6

Part No.	Description	Dimensions Bus Connector
1161870000	PB-DP SUB-D ZF TERM	53,6 x 42 x 16,8 mm
1161880000	PB-DP SUB-D ZF T PS	53,6 x 42 x 16,8 mm

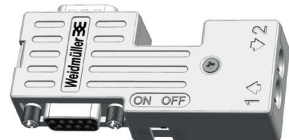

Input 1 and Outout 2	
L	(30)
L1	24
L2	7
L3	6

Part No.	Description	Dimensions Bus Connector
2004310000	PB-DP SUB-D ZF TERM S7	77,7 x 34,7 x 16,8 mm
2004320000	PB-DP SUB-D ZF T PS S7	77,7 x 34,7 x 16,8 mm

Circuit diagram

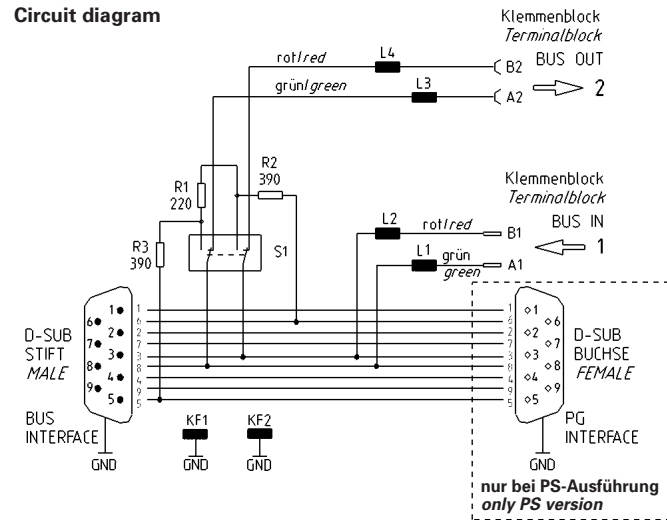

Bus Termination

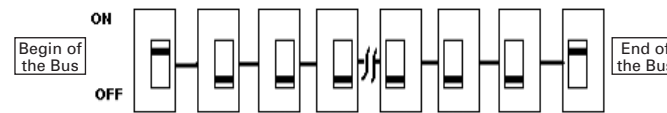

For use in NFPA 79 Applications only.
Suitable for pollution degree 2 environment only.

(Shown 1173240000)



Remove the 2 fixing screws
with Pozidriv screwdriver PZ1

Bus connector in open condition
without housing cover and without
shield clamp. Clamps: Position of white
locking slide for clamp close or open.

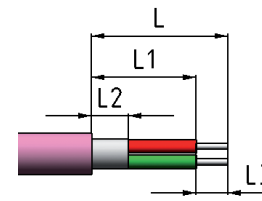
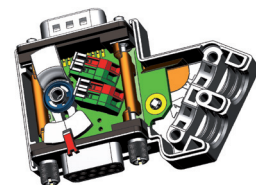

Strip off Profibus cable in one step
with multi-stage strip off tool
(recommended Weidmüller CST vario)
or with standard strip off tool in a few steps.
Strip off single wires to 6 +/-1mm and
with strip tool (recommended Weidmüller
STRIPAX).

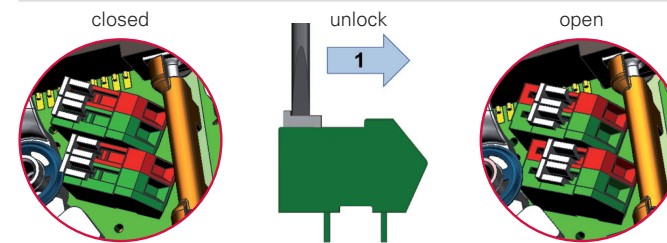

Opening of cage clamp terminals

To open the terminals insert screwdriver with blade 2,5 x 0,4 into the
white locking slide and move them forward (toward the cable output).

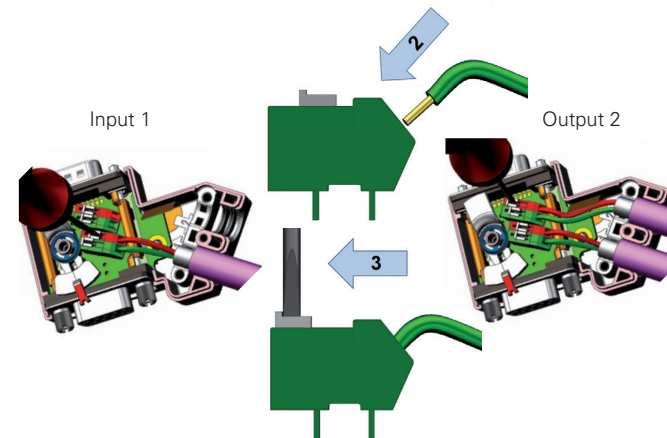

**Insert the cable wires for the
terminals Profibus cable**
into the clamps A1 and B1 (2) and
close the terminals (3).

**Insert the cable wires for the
outgoing Profibus cable**
into A2 and B2 (2) and close the
terminals (3).

Attention! For SPECIAL and COMPACT
Only operate termination switch if the D-Sub connector is not screw
locked.

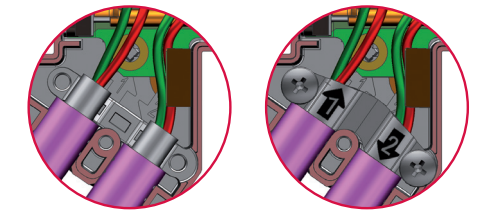

Turn on shield clamp

Take care, that the cable shield lay fully on front cable shield support
(see left picture). Lock on the 2 fixing screws with Pozidriv
screwdriver PZ1.

Torque: max. 0,3 Nm.

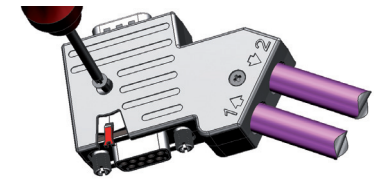

Locking of housing cover

Tighten the 2 fixing screws with Pozidriv screwdriver PZ1

Torque: max. 0,3 Nm.

Bus termination (termination resistors) OFF/ON

For the bus termination with active termination move the switch lever to
position "ON". For the bus termination for the 1st participant on the input
side the output bus cable needs to be terminated on the input side (1) and
move the switch lever to the position "ON".

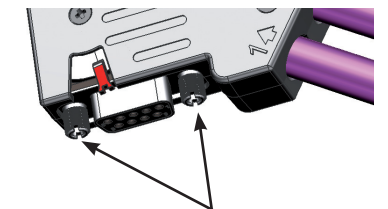

Mounting on the D-Sub of the Profibus interface

Torque of knurled locking screw: max. 0,3 Nm.