

RoHS Compliant

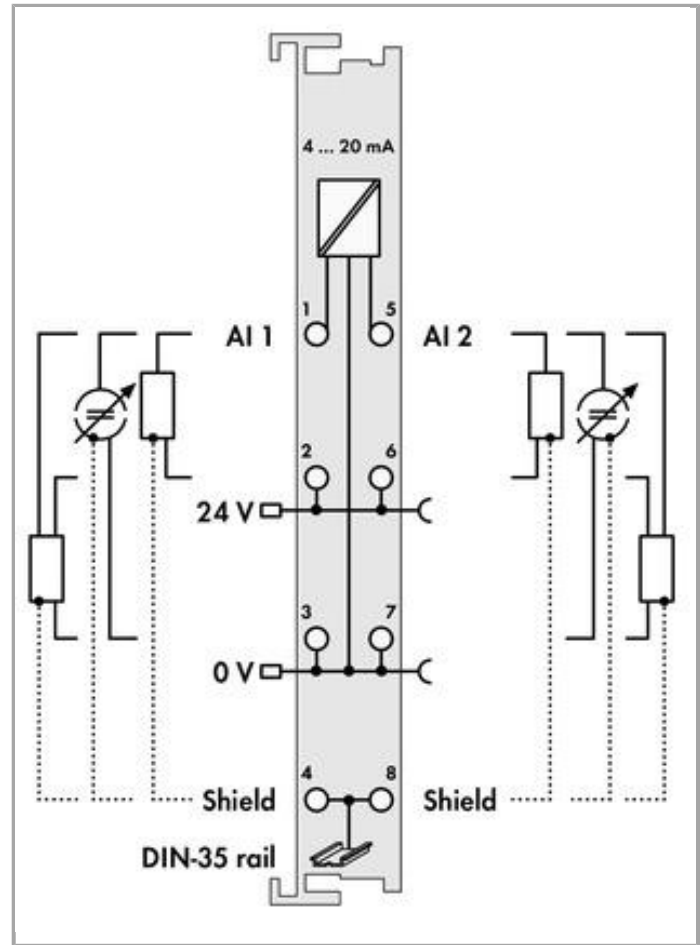
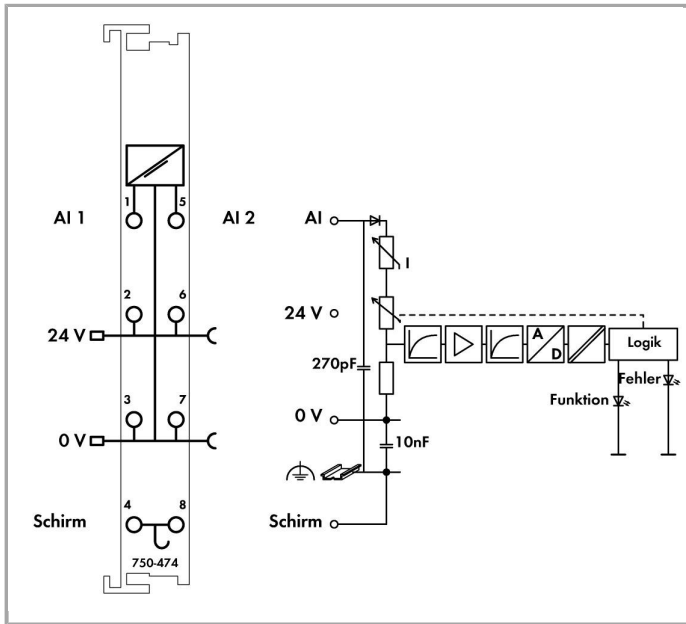

Artikelbeschreibung

Das Analogeingangsmodul hat die Aufgabe, die im Feld befindlichen Messumformer zu versorgen und analoge Messsignale galvanisch getrennt zum Bussystem zu übertragen.

Die Versorgungsspannung von 24 V wird über die Leistungskontakte für das Feld eingespeist.

Der Schirmanschluss ist direkt zur Tragschiene geführt.

Der Überlastschutz schaltet den Messeingang ab einem Strom von ca. 25 mA in den hochohmigen Zustand. Der hochohmige Zustand wird bei Rückkehr in den normalen Messbereich automatisch zurückgesetzt.

Dieses Modul liefert die Spannungsversorgung für 2-Leiter-Messumformer, die keine eigene Spannungsversorgung haben.

Daten

Technische Daten

| | |
|-------------------------------------|--------------------------|
| Anzahl der analogen Eingänge | 2 |
| Anzahl der Kanäle insgesamt (Modul) | 2 |
| Signalart | Strom |
| Signalart Strom | DC 4 ... 20 mA |
| Sensoranschluss | 2 x (2 Leiter, 3 Leiter) |



| | |
|---|--|
| Eingangsfrequenz analog | 50 Hz |
| Eingangsspannung max. | 24 V |
| Eingangsspannung Hinweis | nichtlinear, da überlastungsgeschützt $U = 1,2 V + 160 \Omega \times I_{\text{mess}}$ |
| Signalcharakteristik | Single-Ended |
| Auflösung [Bit] | 15 Bit |
| Eingangswiderstand max. | 220 Ω |
| Datenbreite | 2 x 16 Bit Daten; 2 x 8 Bit Steuer/Status (optional) |
| Überspannungsschutz | 30 V verpolungssicher |
| Störunterdrückung bei Abtastfrequenz | -100 dB |
| Störunterdrückung oberhalb Abtastfrequenz | -40 dB |
| Wandlungszeit typ. | 80 ms |
| Messfehler, Bezugstemperatur | 25 °C |
| Messfehler, Abweichung max. vom Messbereichsendwert | 0.1 % |
| Temperaturfehler max. vom Messbereichsendwert | 0.01 %/K |
| Versorgungsspannung System | DC 5 V; über Datenkontakte |
| Stromaufnahme Systemversorgung (5 V) | 75 mA |
| Versorgungsspannung Feld | DC 24 V (-25 ... 30 %); über Leistungskontakte (Einspeisung über Messerkontakt; Weiterleitung über Federkontakt) |
| Potentialtrennung | 500 V System/Feld |
| Anzahl Leistungskontakte eingehend | 2 |
| Anzahl Leistungskontakte ausgehend | 2 |

Anschlussdaten

| | |
|---------------------------------|--|
| Anschlusstechnik: Ein-/Ausgänge | 8 x CAGE CLAMP® |
| Anschlusstyp 1 | Ein-/Ausgänge |
| Eindrähtiger Leiter | 0,08 ... 2,5 mm ² / 28 ... 14 AWG |
| Feindrähtiger Leiter | 0,08 ... 2,5 mm ² / 28 ... 14 AWG |
| Abisolierlänge | 8 ... 9 mm / 0.31 ... 0.35 inch |

Geometrische Daten

| | |
|-------------------------------|----------------------|
| Breite | 12 mm / 0.472 inch |
| Höhe | 69,8 mm / 2.748 inch |
| Höhe ab Oberkante Tragschiene | 62,6 mm / 2.465 inch |
| Tiefe | 100 mm / 3.937 inch |

Mechanische Daten

| | |
|------------|----------------|
| Montageart | Tragschiene 35 |
|------------|----------------|

Werkstoffdaten

| | |
|-------|-----------|
| Farbe | lichtgrau |
|-------|-----------|

| | |
|---------------------------|----------------------------|
| Gehäusewerkstoff | Polycarbonat, Polyamid 6.6 |
| Brandlast | 1.311 MJ |
| Gewicht | 53.215 g |
| Konformitätskennzeichnung | CE |

Umgebungsbedingungen

| | |
|---|---|
| Umgebungstemperatur (Betrieb) | 0 ... 55 °C |
| Umgebungstemperatur (Lagerung) | -40 ... 85 °C |
| Schutzart | IP20 |
| Verschmutzungsgrad (5) | 2 gemäß IEC 61131-2 |
| Betriebshöhe | 0 ... 2000 m |
| Einbaulage | horizontal stehend/liegend; vertikal |
| Relative Feuchte (ohne Betauung) | 95 % |
| Vibrationsfestigkeit | 4g gemäß IEC 60068-2-6 |
| Schockfestigkeit | 15g gemäß IEC 60068-2-27 |
| EMV-Störfestigkeit | gemäß EN 61000-6-2, Schiffbereich |
| EMV-Störaussendung | gemäß EN 61000-6-4, Schiffbereich |
| Beanspruchung durch Schadstoffe | gemäß IEC 60068-2-42 und IEC 60068-2-43 |
| Zulässige Schadstoffkonzentration H ₂ S bei einer relativen Feuchte < 75 % | 10 ppm |
| Zulässige Schadstoffkonzentration SO ₂ bei einer relativen Feuchte < 75 % | 25 ppm |

Kaufmännische Daten

| | |
|-----------------|-----------------|
| Ursprungsland | DE |
| GTIN | 4045454393281 |
| Zolltarifnummer | 85389099990 |
| Produktgruppe | 15 (I/O-System) |
| eCl@ss 9.0 | 27-24-26-01 |
| eCl@ss 8.0 | 27-24-26-01 |
| ETIM 6.0 | EC001596 |
| ETIM 5.0 | EC001596 |

Zulassungen / Zertifikate

Ex-Zulassungen

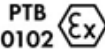
| Logo | Zulassung | Zertifikatsname |
|--|-----------------------------|--------------------------|
|  | ATEX TUEV Nord Cert GmbH | TÜV 07 ATEX 554086 X en. |
| | INMETRO | BR-Ex_TÜV 12.1297 X |

TÜV Rheinland do Brasil Ltda.



TUEV Nord
TUEV Nord Cert GmbH

IECEX TUN 09.0001 X







UL
Underwriters Laboratories Inc. (HAZARDOUS LOCATIONS)

E198726 Sec.1 (HAZARDOUS LOCATIONS)



Länderspezifische Zulassungen

| Logo | Zulassung | Zertifikatsname |
|--|---|---------------------|
|  | KC National Radio Research Agency | MSIP-REM-W43-AIM750 |
|  | KC National Radio Research Agency | MSIP-REM-W43-AIM750 |

Schiff Zulassungen

| Logo | Zulassung | Zertifikatsname |
|--|---|------------------|
|  | ABS American Bureau of Shipping | 16-HG1554285-PDA |
|  | BV Bureau Veritas S.A. | 13453/DO BV |
|  | DNV GL Det Norske Veritas, Germanischer Lloyd | TAA0000194 |
|  | DNV GL Det Norske Veritas, Germanischer Lloyd | TAA0000194 |
|  | DNV DNV Germany GmbH | A-14093 |
| | LR Lloyds Register | 02/20026 (E5) |









| | | |
|---|--------------------------------------|-------------------|
|  | NK Nippon Kaiji Kyokai | TA17255M |
|  | PRS Polski Rejestr Statkow | TE/1989/880590/13 |
|  | RINA RINA Germany GmbH | ELE134212XG |















UL-Zulassungen

| Logo | Zulassung | Zertifikatsname |
|---|---|------------------------------------|
|  | UL UL International Netherlands B.V. (ORDINARY LOCATIONS) | E175199 Sec.1 (ORDINARY LOCATIONS) |

Passende Produkte

Beschriftungsmaterial











| | | |
|--|--|--|
|  | Art-Nr.: 2009-145 Mini-WSB Inline; für smartPRINTER; auf Rolle; dehnbar 5 - 5,2 mm; unbedruckt; aufrastbar | www.wago.com/2009-145 |
|  | Art-Nr.: 2009-145/000-002 Mini-WSB Inline; für smartPRINTER; auf Rolle; dehnbar 5 - 5,2 mm; unbedruckt; aufrastbar | www.wago.com/2009-145/000-002 |
|  | Art-Nr.: 2009-145/000-005 Mini-WSB Inline; für smartPRINTER; auf Rolle; dehnbar 5 - 5,2 mm; unbedruckt; aufrastbar | www.wago.com/2009-145/000-005 |
|  | Art-Nr.: 2009-145/000-006 Mini-WSB Inline; für smartPRINTER; auf Rolle; dehnbar 5 - 5,2 mm; unbedruckt; aufrastbar | www.wago.com/2009-145/000-006 |
|  | Art-Nr.: 2009-145/000-007 Mini-WSB Inline; für smartPRINTER; auf Rolle; dehnbar 5 - 5,2 mm; unbedruckt; aufrastbar | www.wago.com/2009-145/000-007 |
|  | Art-Nr.: 2009-145/000-012 Mini-WSB Inline; für smartPRINTER; auf Rolle; dehnbar 5 - 5,2 mm; unbedruckt; aufrastbar | www.wago.com/2009-145/000-012 |

| | | |
|--|--|--|
|  | Art-Nr.: 2009-145/000-023 Mini-WSB Inline; für smartPRINTER; auf Rolle; dehnbar 5 - 5,2 mm; unbedruckt; aufrastbar | www.wago.com/2009-145/000-023 |
|  | Art-Nr.: 2009-145/000-024 Mini-WSB Inline; auf Rolle; dehnbar 5 - 5,2 mm; unbedruckt; aufrastbar | www.wago.com/2009-145/000-024 |
|  | Art-Nr.: 248-501 Mini-WSB-Schnellbeschriftungssystem; unbedruckt; Schildchenbreite 5 mm; 10 Streifen à 10 Schilder pro Karte | www.wago.com/248-501 |
|  | Art-Nr.: 248-501/000-002 Mini-WSB-Beschriftungskarte; als Karte; nicht dehnbar; unbedruckt; aufrastbar | www.wago.com/248-501/000-002 |
|  | Art-Nr.: 248-501/000-005 Mini-WSB-Beschriftungskarte; als Karte; unbedruckt; aufrastbar | www.wago.com/248-501/000-005 |
|  | Art-Nr.: 248-501/000-006 Mini-WSB-Beschriftungskarte; als Karte; nicht dehnbar; unbedruckt; aufrastbar | www.wago.com/248-501/000-006 |
|  | Art-Nr.: 248-501/000-007 Mini-WSB-Beschriftungskarte; als Karte; nicht dehnbar; unbedruckt; aufrastbar | www.wago.com/248-501/000-007 |
|  | Art-Nr.: 248-501/000-012 Mini-WSB-Beschriftungskarte; als Karte; nicht dehnbar; unbedruckt; aufrastbar | www.wago.com/248-501/000-012 |
|  | Art-Nr.: 248-501/000-017 Mini-WSB-Beschriftungskarte; als Karte; nicht dehnbar; unbedruckt; aufrastbar | www.wago.com/248-501/000-017 |
|  | Art-Nr.: 248-501/000-023 Mini-WSB-Beschriftungskarte; als Karte; nicht dehnbar; unbedruckt; aufrastbar | www.wago.com/248-501/000-023 |
|  | Art-Nr.: 248-501/000-024 Mini-WSB-Beschriftungskarte; als Karte; nicht dehnbar; unbedruckt; aufrastbar | www.wago.com/248-501/000-024 |
|  | Art-Nr.: 750-100 Beschriftungskarte; als Bogen DIN A4; unbedruckt | www.wago.com/750-100 |
|  | Art-Nr.: 750-103 Gruppenschildträger | www.wago.com/750-103 |
|  | Art-Nr.: 750-106 Gruppenschildträger | www.wago.com/750-106 |
| Tragschiene | | |
|  | Art-Nr.: 210-112 Stahltragschiene; 35 x 7,5 mm; 1 mm dick; 2 m lang; gelocht; entsprechend EN 60715; Lochbreite 25 mm; Lochabstand 36 mm | www.wago.com/210-112 |







| | | |
|--|--|--|
|  | Art-Nr.: 210-113 Stahltragschiene; 35 x 7,5 mm; 1 mm dick; 2 m lang; ungelocht; entsprechend EN 60715 | www.wago.com/210-113 |
|  | Art-Nr.: 210-114 Stahltragschiene; 35 x 15 mm; 1,5 mm dick; 2 m lang; ungelocht; ähnlich EN 60715 | www.wago.com/210-114 |
|  | Art-Nr.: 210-115 Stahltragschiene; 35 x 7,5 mm; 1 mm dick; 2 m lang; gelocht; entsprechend EN 60715; Lochbreite 18 mm; Lochabstand 25 mm | www.wago.com/210-115 |
|  | Art-Nr.: 210-118 Stahltragschiene; 35 x 15 mm; 2,3 mm dick; 2 m lang; ungelocht; entsprechend EN 60715 | www.wago.com/210-118 |
|  | Art-Nr.: 210-196 Aluminiumtragschiene; 35 x 8,2 mm; 1,6 mm dick; 2 m lang; ungelocht; ähnlich EN 60715 | www.wago.com/210-196 |
|  | Art-Nr.: 210-197 Stahltragschiene; 35 x 15 mm; 1,5 mm dick; 2 m lang; gelocht; ähnlich EN 60715 | www.wago.com/210-197 |
|  | Art-Nr.: 210-198 Kupfertragschiene; 35 x 15 mm; 2,3 mm dick; 2 m lang; ungelocht; entsprechend EN 60715 | www.wago.com/210-198 |
|  | Art-Nr.: 210-504 Stahltragschiene; 35 x 7,5 mm; 1 mm dick; 2 m lang; gelocht; bandverzinkt; entsprechend EN 60715 | www.wago.com/210-504 |
|  | Art-Nr.: 210-505 Stahltragschiene; 35 x 7,5 mm; 1 mm dick; 2 m lang; ungelocht; bandverzinkt; entsprechend EN 60715 | www.wago.com/210-505 |
|  | Art-Nr.: 210-506 Stahltragschiene; 35 x 15 mm; 1,5 mm dick; 2 m lang; ungelocht; bandverzinkt; ähnlich EN 60715 | www.wago.com/210-506 |
|  | Art-Nr.: 210-508 Stahltragschiene; 35 x 15 mm; 1,5 mm dick; 2 m lang; gelocht; bandverzinkt; ähnlich EN 60715 | www.wago.com/210-508 |

Systemgehäuse

| | | |
|--|---|--|
|  | Art-Nr.: 850-804 IP65-Systemgehäuse; Edelstahl; BxHxT (400x123x200 mm); 4 x M20-, 16 x M16-, 28 x M12-Verschraubung | www.wago.com/850-804 |
|  | Art-Nr.: 850-804/000-001 IP65-Systemgehäuse; Edelstahl; BxHxT (400x123x200 mm); 2 x M20-, 13 x M16-, 32 x M12-Verschraubung | www.wago.com/850-804/000-001 |
|  | Art-Nr.: 850-805 IP65-Systemgehäuse; Edelstahl; BxHxT (600x123x200 mm); 4 x M20-, 19 x M16-, 67 x M12-Verschraubung | www.wago.com/850-805 |
|  | Art-Nr.: 850-814/002-000 IP65-Systemgehäuse; Stahlblech (RAL 7035); BxHxT (200x120x200 mm); ohne Flanschplatte | www.wago.com/850-814/002-000 |
|  | Art-Nr.: 850-815/002-000 IP65-Systemgehäuse; Stahlblech (RAL 7035); BxHxT (300x120x200 mm); ohne Flanschplatte | www.wago.com/850-815/002-000 |
|  | Art-Nr.: 850-816/002-000 IP65-Systemgehäuse; Stahlblech (RAL 7035); BxHxT (400x120x200 mm); ohne Flanschplatte | www.wago.com/850-816/002-000 |

| | | |
|--|--|--|
|  | Art-Nr.: 850-817/002-000 IP65-Systemgehäuse; Stahlblech (RAL 7035); BxHxT (600x120x200 mm); ohne Flanschplatte | www.wago.com/850-817/002-000 |
|  | Art-Nr.: 850-825 IP65-Systemgehäuse; Aluminium (RAL 7032); BxHxT (160x100x160 mm); 9 x M12, 4 x M20 | www.wago.com/850-825 |
|  | Art-Nr.: 850-826 IP65-Systemgehäuse; Aluminium (RAL 7032); BxHxT (240x100x160 mm); 4 x M20-, 4 x M16-, 14 x M12-Verschraubung | www.wago.com/850-826 |
|  | Art-Nr.: 850-826/002-000 IP65-Systemgehäuse; Aluminium (RAL 7035); BxHxT (240x100x160 mm); 4 x M20-, 4 x M16-, 14 x M12-Verschraubung | www.wago.com/850-826/002-000 |
|  | Art-Nr.: 850-827 IP65-Systemgehäuse; Aluminium (RAL 7032); BxHxT (320x100x160 mm); 4 x M20-, 8 x M16-, 17 x M12-Verschraubung | www.wago.com/850-827 |
|  | Art-Nr.: 850-827/002-000 IP65-Systemgehäuse; Aluminium (RAL 7035); BxHxT (320x100x160 mm); 4 x M20-, 8 x M16-, 17 x M12-Verschraubung | www.wago.com/850-827/002-000 |
|  | Art-Nr.: 850-828 IP65-Systemgehäuse; Aluminium (RAL 7032); BxHxT (480x100x160 mm); 4 x M20-, 10 x M16-, 35 x M12-Verschraubung | www.wago.com/850-828 |
|  | Art-Nr.: 850-828/002-000 IP65-Systemgehäuse; Aluminium (RAL 7035); BxHxT (480x100x160 mm); 4 x M20-, 10 x M16-, 35 x M12-Verschraubung | www.wago.com/850-828/002-000 |
|  | Art-Nr.: 850-834 IP65-Systemgehäuse; Polyester (RAL 7032); BxHxT (164x100x164 mm); 9 x M12, 4 x M20 | www.wago.com/850-834 |
|  | Art-Nr.: 850-835 IP65-Systemgehäuse; Polyester (RAL 7032); BxHxT (244x100x164 mm); 4 x M20-, 4 x M16-, 14 x M12-Verschraubung | www.wago.com/850-835 |
|  | Art-Nr.: 850-836 IP65-Systemgehäuse; Polyester (RAL 7032); BxHxT (324x100x164 mm); 4 x M20-, 8 x M16-, 17 x M12-Verschraubung | www.wago.com/850-836 |

Schirmanschluss

| | | |
|--|--|--|
|  | Art-Nr.: 790-108 Schirmklemmbügel; 11 mm breit; kontaktierbarer Schirmdurchmesser | www.wago.com/790-108 |
|  | Art-Nr.: 790-116 Schirmklemmbügel; 19 mm breit; kontaktierbarer Schirmdurchmesser; 7 ... 16 mm | www.wago.com/790-116 |
|  | Art-Nr.: 790-124 Schirmklemmbügel; 27 mm breit; kontaktierbarer Schirmdurchmesser; 6 ... 24 mm | www.wago.com/790-124 |
|  | Art-Nr.: 790-140 Schirmklemmbügel; kontaktierbarer Schirmdurchmesser | www.wago.com/790-140 |
|  | Art-Nr.: 790-208 Schirmklemmbügel; 12,4 mm breit; 3 ... 8 mm | www.wago.com/790-208 |
|  | Art-Nr.: 790-216 Schirmklemmbügel; 21,8 mm breit; 6 ... 16 mm | www.wago.com/790-216 |



Art-Nr.: 790-220
Schirmklemmbügel; 30 mm breit; 6 ... 20 mm

www.wago.com/790-220

Potentialeinspeisung



Art-Nr.: 750-601
Potentialeinspeisung; DC 24 V

www.wago.com/750-601



Art-Nr.: 750-602
Potentialeinspeisung; DC 24 V

www.wago.com/750-602



Art-Nr.: 750-610
Potentialeinspeisung; DC 24 V; Sicherungshalter; Diagnose

www.wago.com/750-610



Art-Nr.: 750-612
Potentialeinspeisung; AC/DC 0 ... 230 V

www.wago.com/750-612

Downloads

Dokumentation

Handbuch

| | | | |
|--|------------------------|---------------|----------|
| 2-Kanal, 4 - 20 mA, single ended 16 Bit | V 1.1.0 Mar 3, 2015 | PDF 2,1 MB | Download |
|--|------------------------|---------------|----------|

Ausschreibungstext

| | | | |
|-----------------------|--------------|----------------|----------|
| 750-474 IO-Klemmen | Jan 20, 2016 | DOC 30,7 kB | Download |
|-----------------------|--------------|----------------|----------|

Weitere Informationen

| | | | |
|---|-------------------------|-----------------|----------|
| Entsorgung; Elektro- und Elektronikgeräte, Verpackung | V 1.0.0 Oct 15, 2018 | PDF 269,1 kB | Download |
|---|-------------------------|-----------------|----------|

Systembeschreibung

| | | | |
|--|------------------------|---------------|----------|
| Projektierungshinweise Randbedingungen und Empfehlungen zur Erhöhung der Betriebssicherheit | V 2.0.1 May 3, 2011 | PDF 1,8 MB | Download |
|--|------------------------|---------------|----------|

| | | | |
|---|------------------------|---------------|----------|
| Einsatz in explosionsgefährdeten Bereichen Begriffsdefinition, Kennzeichnung und Errichtungsbestimmungen | V 1.0.0 May 8, 2014 | PDF 1,0 MB | Download |
|---|------------------------|---------------|----------|

| | | | |
|---|-------------|-----------------|----------|
| Übersicht Zulassungen WAGO-I/O-SYSTEM 750 | Jun 2, 2017 | PDF 341,4 kB | Download |
|---|-------------|-----------------|----------|

| | | | |
|--|--------------|---------------|----------|
| I/O-System – Serie 750/753 Allgemeine Produktinformationen | May 29, 2018 | PDF 1,6 MB | Download |
|--|--------------|---------------|----------|

smartDATA



CAD Daten

| | | |
|---------------------|-----|----------|
| 3D Download 750-474 | URL | Download |
|---------------------|-----|----------|

Gerätedateien

Gerätetreiber

| | | | |
|--|-------------------------|---------------|----------|
| WAGO USB Service Kabel Treiber / Serie 750 und 857 | 6.5.3.0 Sep 10, 2014 | ZIP 4,8 MB | Download |
|--|-------------------------|---------------|----------|

Produktfamilie

I/O-System – Serie 750/753

Die dezentrale Peripherie für alle Anwendungen: Das WAGO-I/O-SYSTEM 750 bietet mit weit über 500 I/O-Modulen und Feldbuskopplern alle Funktionen, die Sie für Ihre Automation benötigen – für jeden Feldbus.

[Mehr über die Produktfamilie erfahren](#)

[Alle Produkte der Familie anzeigen](#)

Änderungen vorbehalten.

WAGO Kontakttechnik GmbH & Co. KG
Hansastr. 27
32423 Minden
Telefon: +49571 887-0
E-Mail: info.de@wago.com | Web: www.wago.com

Haben Sie Fragen zu unseren Produkten?
Wir stehen Ihnen telefonisch unter +49 (571) 887-44222 gern zur Verfügung.