

RoHS Compliant

BOMcheck.net

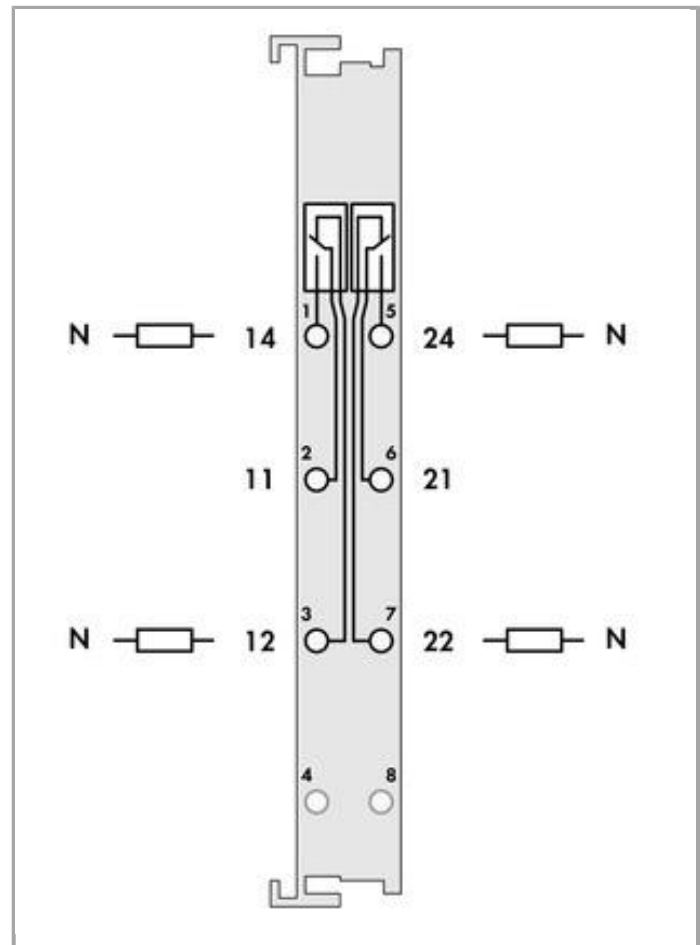
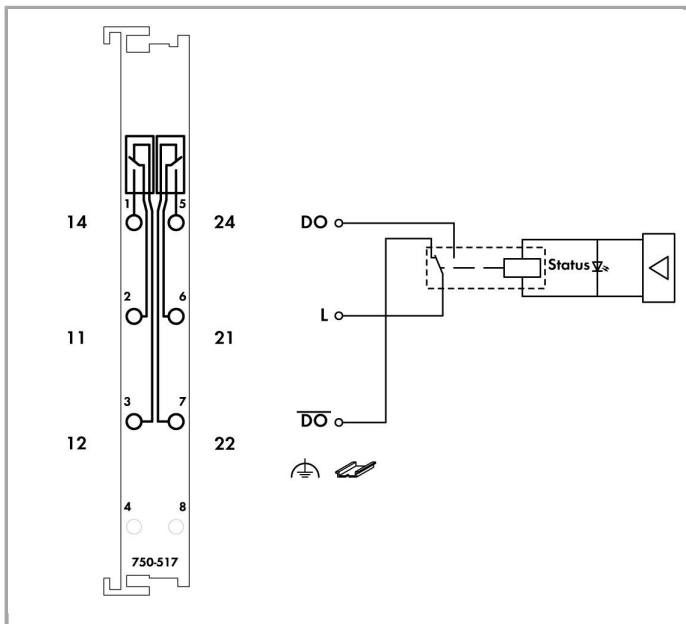

Artikelbeschreibung

Über das Digitalausgangsmodul werden Steuersignale aus dem Automatisierungsgerät an die angeschlossenen Aktoren weitergegeben.

Zur Ansteuerung der Relais wird die interne Systemspannung genutzt.

Die Kontakte sind potentialfrei angeordnet.

Der Ansteuerungszustand des Relais wird über LED signalisiert.

Daten

Technische Daten

Anzahl der digitalen Ausgänge	2
Anzahl der Kanäle insgesamt (Modul)	2
Aktoranschluss	2 x (1 Leiter)
Ausführung der Ausgangsschaltung	2 Wechsler Relais
Ausgangscharakteristik	potentialfrei
Schaltfrequenz max.	0,1Hz
Schaltfrequenz max	0.1 Hz



Lastart der Schaltfrequenz	Nennlast
Schaltspannung max.	AC 250 V, DC 300 V V
Schaltstrom Hinweis	1 A bei AC 250 V und DC 40 V; 0,15 A bei DC 300 V
Schaltspannung min.	12 V
Schaltstrom min.	100 mA
Ansprechzeit max.	8 ms
Abfallzeit max.	4 ms
Schaltspiele elektrisch min. (bei max. ohmscher Last)	10×10^5
Schaltspiele mechanisch min. (bei max. ohmscher Last)	5×10^6
Datenbreite Ausgangsdaten (intern) max.	2 Bit
Versorgungsspannung System	DC 5 V; über Datenkontakte
Stromaufnahme Systemversorgung (5 V)	90 mA
Potentialtrennung Feld – System	1500 V AC (1 min)
Anzeigeelemente	LED (A, E) grün: Status Relais 1, Relais 2

Anschlussdaten

Anschluss technik: Ein-/Ausgänge	8 x CAGE CLAMP®
Anschluss typ 1	Ein-/Ausgänge
Eindrähtiger Leiter	0,08 ... 2,5 mm ² / 28 ... 14 AWG
Feindrähtiger Leiter	0,08 ... 2,5 mm ² / 28 ... 14 AWG
Abisolierlänge	8 ... 9 mm / 0.31 ... 0.35 inch

Geometrische Daten

Breite	12 mm / 0.472 inch
Höhe	67,8 mm / 2.669 inch
Höhe ab Oberkante Tragschiene	60,6 mm / 2.386 inch
Tiefe	100 mm / 3.937 inch

Mechanische Daten

Montageart	Tragschiene 35
------------	----------------

Werkstoffdaten

Farbe	lichtgrau
Kontaktwerkstoff	Ag-Legierung
Gehäusewerkstoff	Polycarbonat, Polyamid 6.6
Brandlast	1.394 MJ
Gewicht	52.363 g
Konformitätskennzeichnung	CE

Umgebungsbedingungen



Umgebungstemperatur (Betrieb)	0 ... 55 °C
Umgebungstemperatur (Lagerung)	-40 ... 85 °C
Schutzart	IP20
Verschmutzungsgrad (5)	2 gemäß IEC 61131-2
Betriebshöhe	0 ... 2000 m
Einbaulage	horizontal stehend/liegend; vertikal
Relative Feuchte (ohne Betauung)	95 %
Vibrationsfestigkeit	4g gemäß IEC 60068-2-6
Schockfestigkeit	15g gemäß IEC 60068-2-27
EMV-Störfestigkeit	gemäß EN 61000-6-2, Schiffbereich
EMV-Störaussendung	gemäß EN 61000-6-4, Schiffbereich
Beanspruchung durch Schadstoffe	gemäß IEC 60068-2-42 und IEC 60068-2-43
Zulässige Schadstoffkonzentration H ₂ S bei einer relativen Feuchte < 75 %	10 ppm
Zulässige Schadstoffkonzentration SO ₂ bei einer relativen Feuchte < 75 %	25 ppm

Kaufmännische Daten

Ursprungsland	DE
GTIN	4045454393519
Zolltarifnummer	85371098990
Produktgruppe	15 (I/O-System)
eCl@ss 9.0	27-24-26-04
eCl@ss 8.0	27-24-26-04
ETIM 6.0	EC001599
ETIM 5.0	EC001599

Zulassungen / Zertifikate

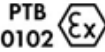
Ex-Zulassungen









Logo	Zulassung	Zertifikatsname
	ATEX TUEV Nord Cert GmbH	TÜV 07 ATEX 554086 X en.
	TUEV Nord TUEV Nord Cert GmbH	IECEx TUN 09.0001 X
	UL Underwriters Laboratories Inc. (HAZARDOUS LOCATIONS)	E198726 Sec.1 (HAZARDOUS LOCATIONS)



Länderspezifische Zulassungen

Logo	Zulassung	Zertifikatsname
	KC National Radio Research Agency	MSIP-REM-W43-DOM750

Schiff Zulassungen

Logo	Zulassung	Zertifikatsname
	ABS American Bureau of Shipping	16-HG1554285-PDA
	BV Bureau Veritas S.A.	13453/DO BV
	DNV GL Det Norske Veritas, Germanischer Lloyd	TAA0000194
	DNV GL Det Norske Veritas, Germanischer Lloyd	TAA0000194
	DNV DNV Germany GmbH	A-14093
	GL Germanischer Lloyd	26 898 - 05 HH
	LR Lloyds Register	02/20026 (E5)
	NK Nippon Kaiji Kyokai	TA17255M
	PRS	TE/1989/880590/13



Polski Rejestr Statkow



RINA
RINA Germany GmbH

ELE134212XG

UL-Zulassungen

Logo	Zulassung	Zertifikatsname
	UL UL International Netherlands B.V. (ORDINARY LOCATIONS)	E175199 Sec.1 (ORDINARY LOCATIONS)

Passende Produkte

Beschriftungsmaterial

	Art-Nr.: 2009-145 Mini-WSB Inline; für smartPRINTER; auf Rolle; dehnbar 5 - 5,2 mm; unbedruckt; aufrastbar	www.wago.com/2009-145
	Art-Nr.: 2009-145/000-002 Mini-WSB Inline; für smartPRINTER; auf Rolle; dehnbar 5 - 5,2 mm; unbedruckt; aufrastbar	www.wago.com/2009-145/000-002
	Art-Nr.: 2009-145/000-005 Mini-WSB Inline; für smartPRINTER; auf Rolle; dehnbar 5 - 5,2 mm; unbedruckt; aufrastbar	www.wago.com/2009-145/000-005
	Art-Nr.: 2009-145/000-006 Mini-WSB Inline; für smartPRINTER; auf Rolle; dehnbar 5 - 5,2 mm; unbedruckt; aufrastbar	www.wago.com/2009-145/000-006
	Art-Nr.: 2009-145/000-007 Mini-WSB Inline; für smartPRINTER; auf Rolle; dehnbar 5 - 5,2 mm; unbedruckt; aufrastbar	www.wago.com/2009-145/000-007
	Art-Nr.: 2009-145/000-012 Mini-WSB Inline; für smartPRINTER; auf Rolle; dehnbar 5 - 5,2 mm; unbedruckt; aufrastbar	www.wago.com/2009-145/000-012
	Art-Nr.: 2009-145/000-023 Mini-WSB Inline; für smartPRINTER; auf Rolle; dehnbar 5 - 5,2 mm; unbedruckt; aufrastbar	www.wago.com/2009-145/000-023
	Art-Nr.: 2009-145/000-024 Mini-WSB Inline; auf Rolle; dehnbar 5 - 5,2 mm; unbedruckt; aufrastbar	www.wago.com/2009-145/000-024
	Art-Nr.: 248-501 Mini-WSB-Schnellbeschriftungssystem; unbedruckt; Schildchenbreite 5 mm; 10 Streifen à 10 Schilder pro Karte	www.wago.com/248-501



Art-Nr.: 248-501/000-002
Mini-WSB-Beschriftungskarte; als Karte; nicht dehnbar; unbedruckt; aufrastbar

www.wago.com/248-501/000-002



Art-Nr.: 248-501/000-005
Mini-WSB-Beschriftungskarte; als Karte; unbedruckt; aufrastbar

www.wago.com/248-501/000-005



Art-Nr.: 248-501/000-006
Mini-WSB-Beschriftungskarte; als Karte; nicht dehnbar; unbedruckt; aufrastbar

www.wago.com/248-501/000-006



Art-Nr.: 248-501/000-007
Mini-WSB-Beschriftungskarte; als Karte; nicht dehnbar; unbedruckt; aufrastbar

www.wago.com/248-501/000-007



Art-Nr.: 248-501/000-012
Mini-WSB-Beschriftungskarte; als Karte; nicht dehnbar; unbedruckt; aufrastbar

www.wago.com/248-501/000-012



Art-Nr.: 248-501/000-017
Mini-WSB-Beschriftungskarte; als Karte; nicht dehnbar; unbedruckt; aufrastbar

www.wago.com/248-501/000-017



Art-Nr.: 248-501/000-023
Mini-WSB-Beschriftungskarte; als Karte; nicht dehnbar; unbedruckt; aufrastbar

www.wago.com/248-501/000-023



Art-Nr.: 248-501/000-024
Mini-WSB-Beschriftungskarte; als Karte; nicht dehnbar; unbedruckt; aufrastbar

www.wago.com/248-501/000-024



Art-Nr.: 750-100
Beschriftungskarte; als Bogen DIN A4; unbedruckt

www.wago.com/750-100



Art-Nr.: 750-103
Gruppenschildträger

www.wago.com/750-103



Art-Nr.: 750-106
Gruppenschildträger

www.wago.com/750-106

Schirmanschluss



Art-Nr.: 790-108
Schirmklemmbügel; 11 mm breit; kontaktierbarer Schirmdurchmesser

www.wago.com/790-108



Art-Nr.: 790-116
Schirmklemmbügel; 19 mm breit; kontaktierbarer Schirmdurchmesser; 7 ... 16 mm

www.wago.com/790-116



Art-Nr.: 790-124
Schirmklemmbügel; 27 mm breit; kontaktierbarer Schirmdurchmesser; 6 ... 24 mm

www.wago.com/790-124



Art-Nr.: 790-140
Schirmklemmbügel; kontaktierbarer Schirmdurchmesser

www.wago.com/790-140



Art-Nr.: 790-208
Schirmklemmbügel; 12,4 mm breit; 3 ... 8 mm

www.wago.com/790-208

Art-Nr.: 790-216



Schirmklemmbügel; 21,8 mm breit; 6 ... 16 mm

www.wago.com/790-216



Art-Nr.: 790-220

Schirmklemmbügel; 30 mm breit; 6 ... 20 mm

www.wago.com/790-220

Systemgehäuse



Art-Nr.: 850-804

IP65-Systemgehäuse; Edelstahl; BxHxT (400x123x200 mm); 4 x M20-, 16 x M16-, 28 x M12-Verschraubung

www.wago.com/850-804



Art-Nr.: 850-804/000-001

IP65-Systemgehäuse; Edelstahl; BxHxT (400x123x200 mm); 2 x M20-, 13 x M16-, 32 x M12-Verschraubung

www.wago.com/850-804/000-001



Art-Nr.: 850-805

IP65-Systemgehäuse; Edelstahl; BxHxT (600x123x200 mm); 4 x M20-, 19 x M16-, 67 x M12-Verschraubung

www.wago.com/850-805



Art-Nr.: 850-814/002-000

IP65-Systemgehäuse; Stahlblech (RAL 7035); BxHxT (200x120x200 mm); ohne Flanschplatte

www.wago.com/850-814/002-000



Art-Nr.: 850-815/002-000

IP65-Systemgehäuse; Stahlblech (RAL 7035); BxHxT (300x120x200 mm); ohne Flanschplatte

www.wago.com/850-815/002-000



Art-Nr.: 850-816/002-000

IP65-Systemgehäuse; Stahlblech (RAL 7035); BxHxT (400x120x200 mm); ohne Flanschplatte

www.wago.com/850-816/002-000



Art-Nr.: 850-817/002-000

IP65-Systemgehäuse; Stahlblech (RAL 7035); BxHxT (600x120x200 mm); ohne Flanschplatte

www.wago.com/850-817/002-000



Art-Nr.: 850-825

IP65-Systemgehäuse; Aluminium (RAL 7032); BxHxT (160x100x160 mm); 9 x M12, 4 x M20

www.wago.com/850-825



Art-Nr.: 850-826

IP65-Systemgehäuse; Aluminium (RAL 7032); BxHxT (240x100x160 mm); 4 x M20-, 4 x M16-, 14 x M12-Verschraubung

www.wago.com/850-826



Art-Nr.: 850-826/002-000

IP65-Systemgehäuse; Aluminium (RAL 7035); BxHxT (240x100x160 mm); 4 x M20-, 4 x M16-, 14 x M12-Verschraubung

www.wago.com/850-826/002-000



Art-Nr.: 850-827

IP65-Systemgehäuse; Aluminium (RAL 7032); BxHxT (320x100x160 mm); 4 x M20-, 8 x M16-, 17 x M12-Verschraubung

www.wago.com/850-827



Art-Nr.: 850-827/002-000

IP65-Systemgehäuse; Aluminium (RAL 7035); BxHxT (320x100x160 mm); 4 x M20-, 8 x M16-, 17 x M12-Verschraubung

www.wago.com/850-827/002-000



Art-Nr.: 850-828

IP65-Systemgehäuse; Aluminium (RAL 7032); BxHxT (480x100x160 mm); 4 x M20-, 10 x M16-, 35 x M12-Verschraubung

www.wago.com/850-828



Art-Nr.: 850-828/002-000

IP65-Systemgehäuse; Aluminium (RAL 7035); BxHxT (480x100x160 mm); 4 x M20-, 10 x M16-, 35 x

www.wago.com/850-828/002-000

M12-Verschraubung



Art-Nr.: 850-834
IP65-Systemgehäuse; Polyester (RAL 7032); BxHxT (164x100x164 mm); 9 x M12, 4 x M20

www.wago.com/850-834



Art-Nr.: 850-835
IP65-Systemgehäuse; Polyester (RAL 7032); BxHxT (244x100x164 mm); 4 x M20-, 4 x M16-, 14 x M12-Verschraubung

www.wago.com/850-835



Art-Nr.: 850-836
IP65-Systemgehäuse; Polyester (RAL 7032); BxHxT (324x100x164 mm); 4 x M20-, 8 x M16-, 17 x M12-Verschraubung

www.wago.com/850-836

Tragschiene



Art-Nr.: 210-112
Stahltragschiene; 35 x 7,5 mm; 1 mm dick; 2 m lang; gelocht; entsprechend EN 60715; Lochbreite 25 mm; Lochabstand 36 mm

www.wago.com/210-112



Art-Nr.: 210-113
Stahltragschiene; 35 x 7,5 mm; 1 mm dick; 2 m lang; ungelocht; entsprechend EN 60715

www.wago.com/210-113



Art-Nr.: 210-114
Stahltragschiene; 35 x 15 mm; 1,5 mm dick; 2 m lang; ungelocht; ähnlich EN 60715

www.wago.com/210-114



Art-Nr.: 210-115
Stahltragschiene; 35 x 7,5 mm; 1 mm dick; 2 m lang; gelocht; entsprechend EN 60715; Lochbreite 18 mm; Lochabstand 25 mm

www.wago.com/210-115



Art-Nr.: 210-118
Stahltragschiene; 35 x 15 mm; 2,3 mm dick; 2 m lang; ungelocht; entsprechend EN 60715

www.wago.com/210-118



Art-Nr.: 210-196
Aluminiumtragschiene; 35 x 8,2 mm; 1,6 mm dick; 2 m lang; ungelocht; ähnlich EN 60715

www.wago.com/210-196



Art-Nr.: 210-197
Stahltragschiene; 35 x 15 mm; 1,5 mm dick; 2 m lang; gelocht; ähnlich EN 60715

www.wago.com/210-197



Art-Nr.: 210-198
Kupfertragschiene; 35 x 15 mm; 2,3 mm dick; 2 m lang; ungelocht; entsprechend EN 60715

www.wago.com/210-198



Art-Nr.: 210-504
Stahltragschiene; 35 x 7,5 mm; 1 mm dick; 2 m lang; gelocht; bandverzinkt; entsprechend EN 60715

www.wago.com/210-504



Art-Nr.: 210-505
Stahltragschiene; 35 x 7,5 mm; 1 mm dick; 2 m lang; ungelocht; bandverzinkt; entsprechend EN 60715

www.wago.com/210-505



Art-Nr.: 210-506
Stahltragschiene; 35 x 15 mm; 1,5 mm dick; 2 m lang; ungelocht; bandverzinkt; ähnlich EN 60715

www.wago.com/210-506



Art-Nr.: 210-508
Stahltragschiene; 35 x 15 mm; 1,5 mm dick; 2 m lang; gelocht; bandverzinkt; ähnlich EN 60715

www.wago.com/210-508

Downloads

Dokumentation

Handbuch

2-Kanal, AC 230 V, 1 A

V 1.1.2

PDF

Download



potentialfrei, 2 Wechsler	Nov 18, 2015	2,1 MB	
---------------------------	--------------	--------	--

Ausschreibungstext

750-517 IO-Klemmen	Jan 20, 2016	DOC 29,2 kB	Download
-----------------------	--------------	----------------	----------

Weitere Informationen

Entsorgung; Elektro- und Elektronikgeräte, Verpackung	V 1.0.0 Oct 15, 2018	PDF 269,1 kB	Download
---	-------------------------	-----------------	----------

Systembeschreibung

Einsatz in explosionsgefährdeten Bereichen Begriffsdefinition, Kennzeichnung und Errichtungsbestimmungen	V 1.0.0 May 8, 2014	PDF 1,0 MB	Download
---	------------------------	---------------	----------

Projektierungshinweise Randbedingungen und Empfehlungen zur Erhöhung der Betriebssicherheit	V 2.0.1 May 3, 2011	PDF 1,8 MB	Download
--	------------------------	---------------	----------

I/O-System – Serie 750/753 Allgemeine Produktinformationen	May 29, 2018	PDF 1,6 MB	Download
--	--------------	---------------	----------

Übersicht Zulassungen WAGO-I/O-SYSTEM 750	Jun 2, 2017	PDF 341,4 kB	Download
---	-------------	-----------------	----------

smartDATA

CAD Daten

3D Download 750-517		URL	Download
---------------------	--	-----	----------

Gerätedateien

Gerätetreiber

WAGO USB Service Kabel Treiber / Serie 750 und 857	6.5.3.0 Sep 10, 2014	ZIP 4,8 MB	Download
--	-------------------------	---------------	----------



Produktfamilie

I/O-System – Serie 750/753

Die dezentrale Peripherie für alle Anwendungen: Das WAGO-I/O-SYSTEM 750 bietet mit weit über 500 I/O-Modulen und Feldbuskopplern alle Funktionen, die Sie für Ihre Automation benötigen – für jeden Feldbus.

[Mehr über die Produktfamilie erfahren](#)

[Alle Produkte der Familie anzeigen](#)

Änderungen vorbehalten.

WAGO Kontakttechnik GmbH & Co. KG
Hansastr. 27
32423 Minden
Telefon: +49571 887-0
E-Mail: info.de@wago.com | Web: www.wago.com

Haben Sie Fragen zu unseren Produkten?
Wir stehen Ihnen telefonisch unter +49 (571) 887-44222 gern zur
Verfügung.