



Kabelverschraubung Kunststoff für Ex Bereich

SKINTOP® K-M ATEX plus

PDF DATASHEET

© 1992 - 2010 CADENAS GmbH

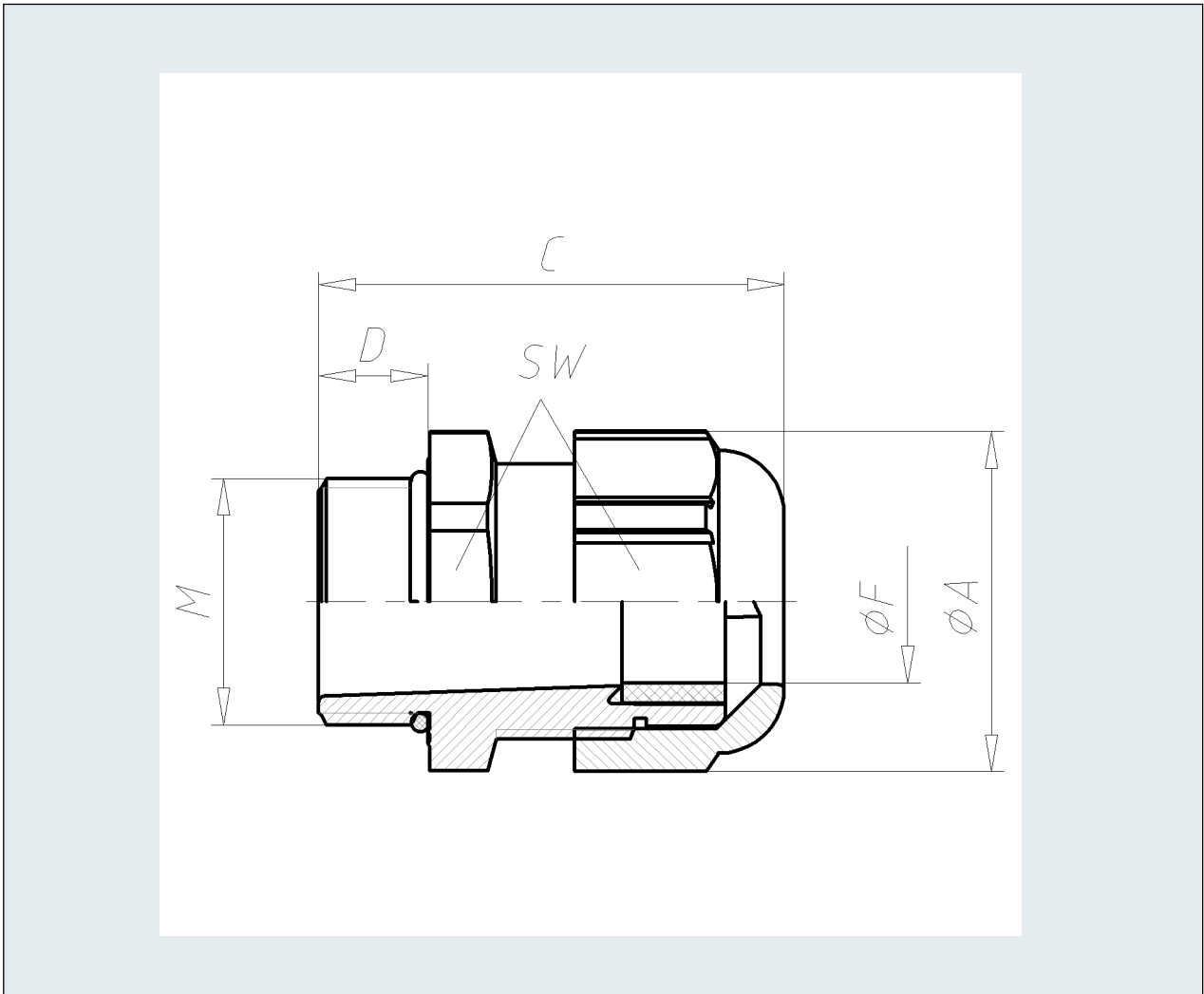
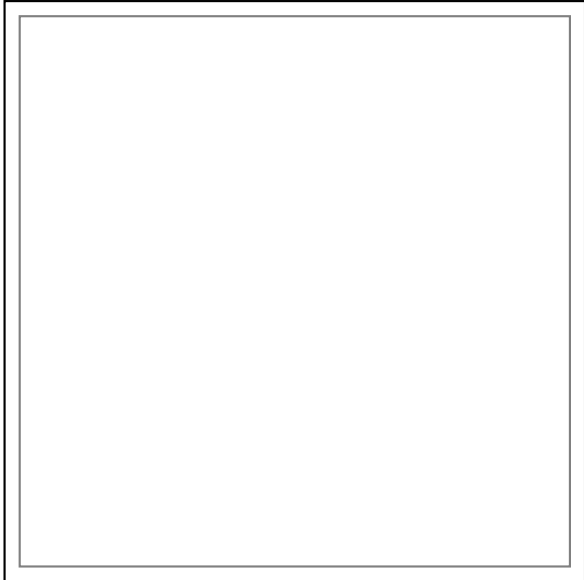
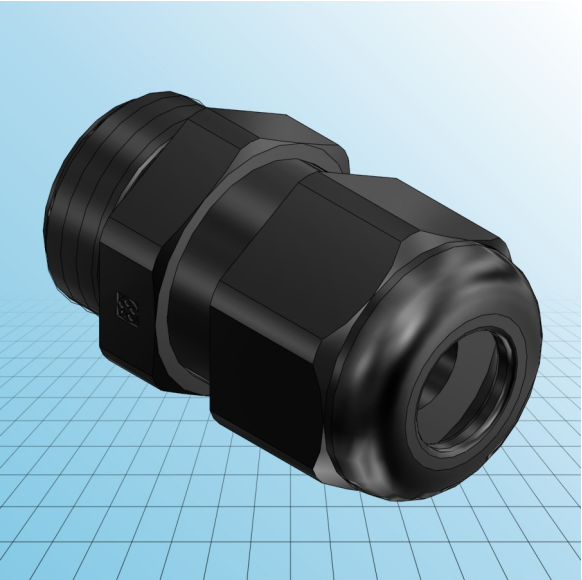



Kabelverschraubung Kunststoff für Ex Bereich

SKINTOP® K-M ATEX plus

IDNR (Identnummer)	
ATN (Artikel-Nummer)	54115210
M (Gewinde)	M 16x1,5
SW (Schlüsselweite / mm)	19
A (Eckmass / mm)	21.1
C (mm)	34
D (mm)	8
FMIN (Klemmbereich min. / mm)	7
FMAX (Klemmbereich max. / mm)	9
F (Kabeldurchmesser / mm)	7
MATERIAL (Material)	Kunststoff