

"Schutzvermerk nach DIN ISO 16016 beachten"

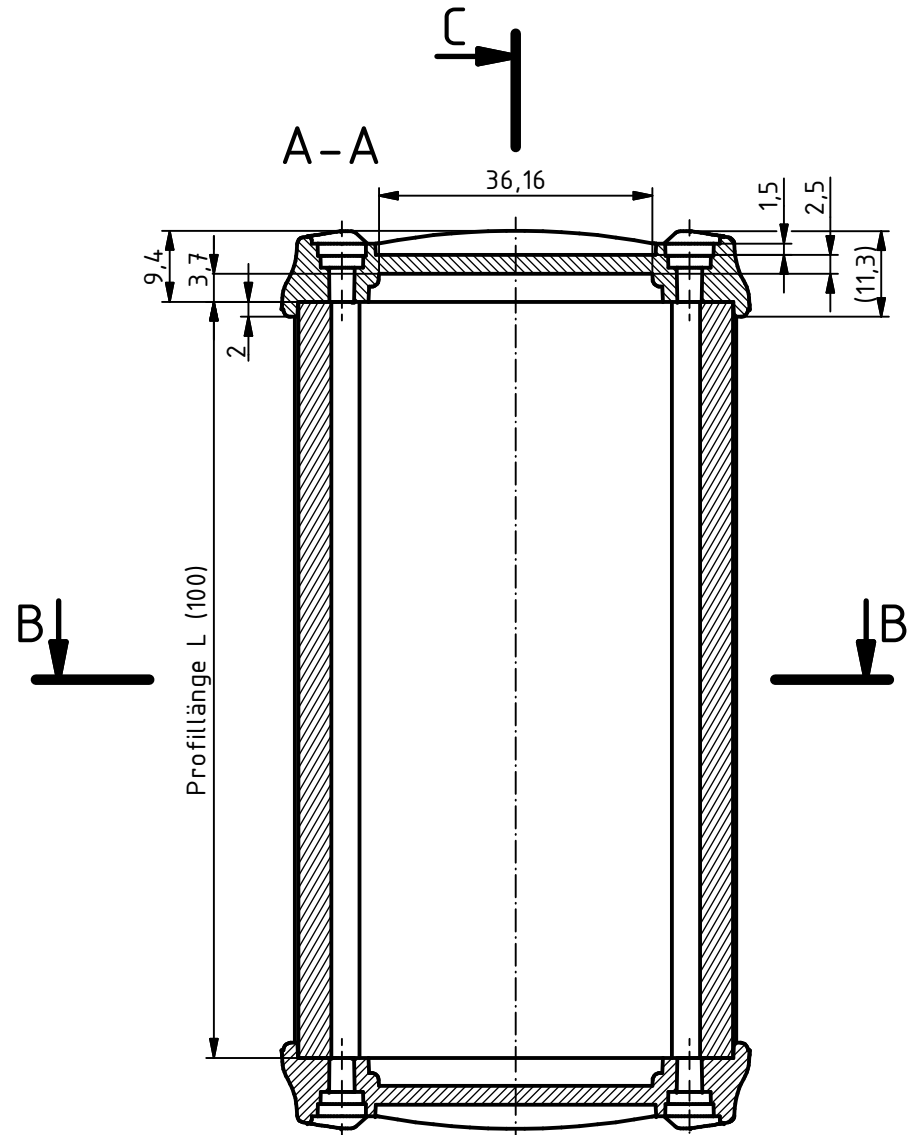

B-B

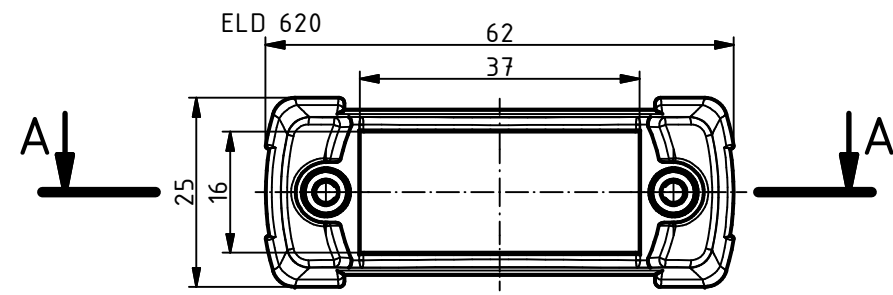
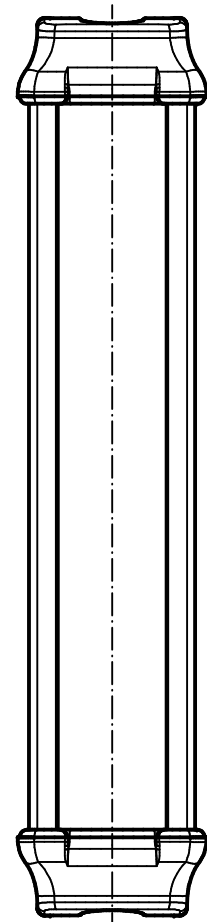
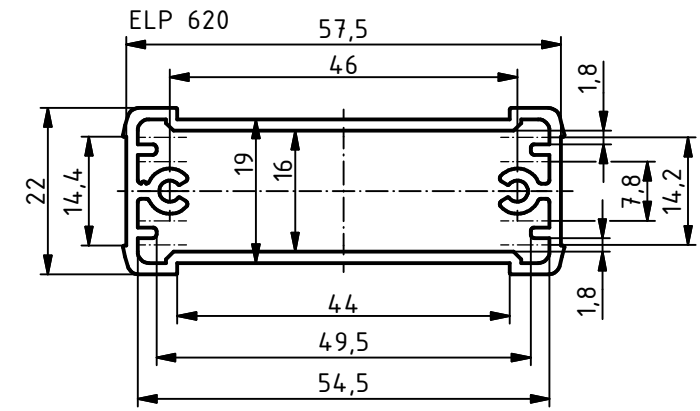
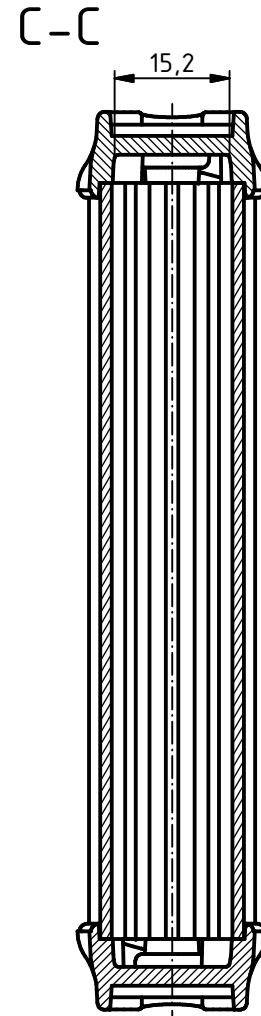
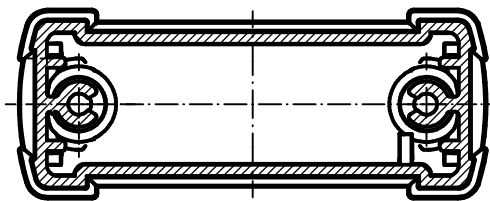

Maßstab: 1:1

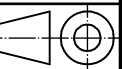

Zchn.Nr.:

Artikel: BOS-Ecoline
ELP 620-100 + ELD 620

Ä.Nr:	Datum:



DISK: 83062100.MT4 ELP 620-100 + ELD 620.idw
Datum: 28.02.2011 JL