

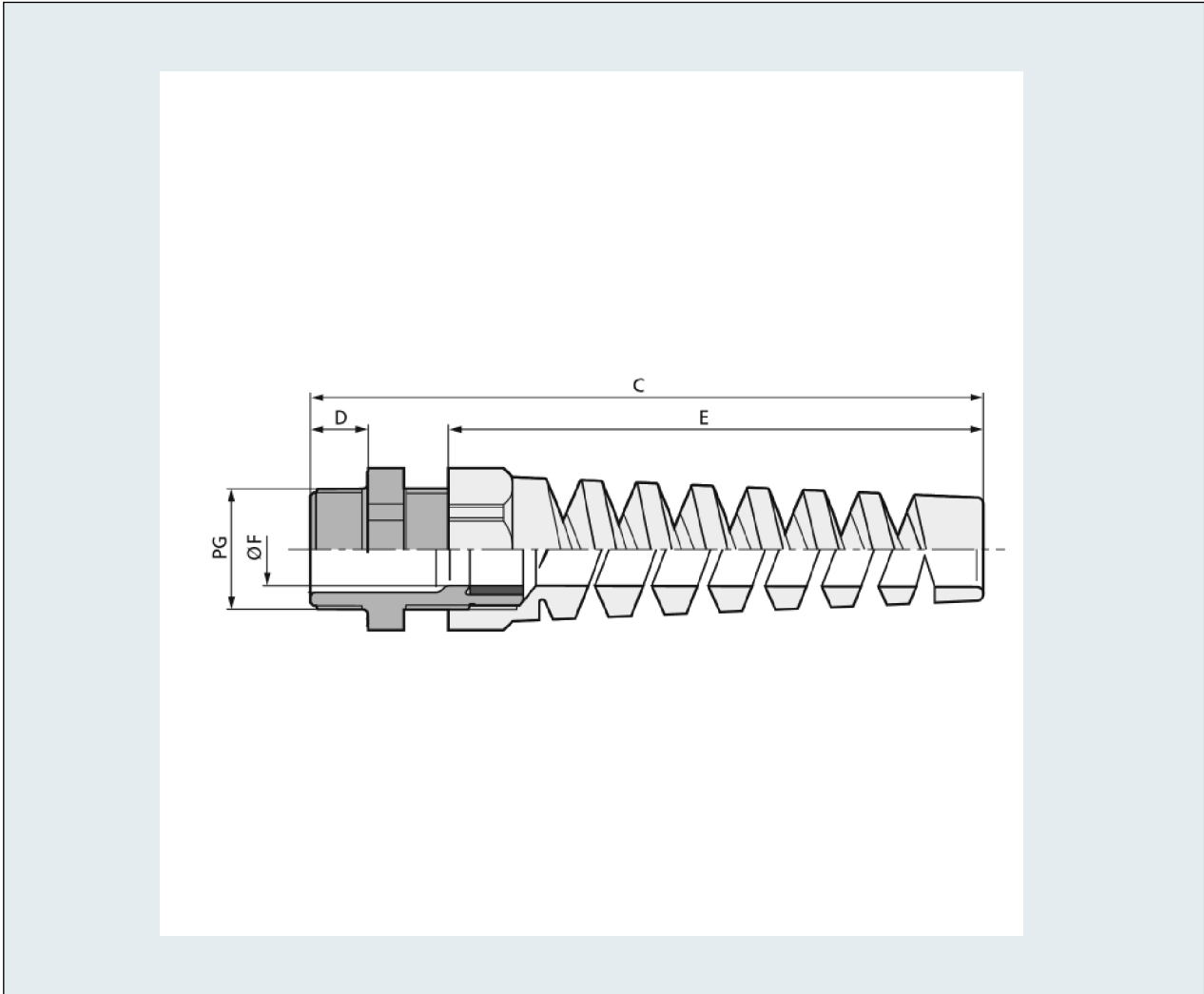

Biegeschutzspirale SKINTOP® BS

PDF DATASHEET

© 1992 - 2010 CADENAS GmbH

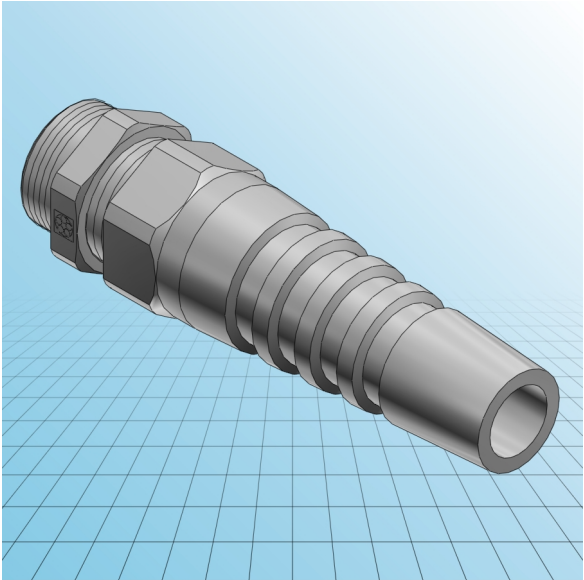



Biegeschutzspirale SKINTOP® BS

PDF DATASHEET

© 1992 - 2010 CADENAS GmbH

IDNR (Identnummer)	
ATN (Artikel-Nummer)	53015820
PG (Gewinde)	PG 11
FMIN (Klemmbereich min. / mm)	4
FMAX (Klemmbereich max. / mm)	10
F (Kabeldurchmesser / mm)	4
SW (Schlüsselweite / mm)	22
A (Eckmass / mm)	24.4
C (mm)	86
D (mm)	8
E (mm)	68
RAL7001 (Silbergrau)	
RAL9005 (Schwarz)	x
MATERIAL (Material)	Kunststoff