

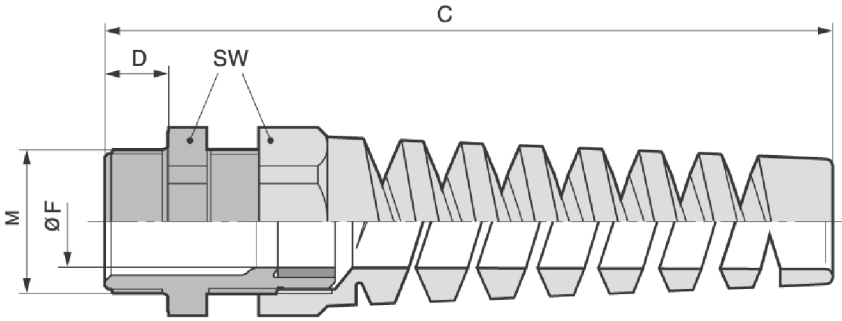

Biegeschutzspirale Kunststoff SKINTOP® BS-M

PDF DATASHEET

© 1992 - 2010 CADENAS GmbH





Biegeschutzspirale Kunststoff

SKINTOP® BS-M

PDF DATASHEET

© 1992 - 2010 CADENAS GmbH

IDNR (Identnummer)	
ATN (Artikel-Nummer)	53111740
M (Gewinde)	M 32x1,5
FMIN (Klemmbereich min. / mm)	11
FMAX (Klemmbereich max. / mm)	21
F (Kabeldurchmesser / mm)	11
SW (Schlüsselweite / mm)	36
A (mm)	40.2
C (mm)	149
D (mm)	10
RAL7001 (Silbergrau)	
RAL7035 (Lichtgrau)	
RAL9005 (Tiefschwarz)	X
MATERIAL (Material)	Kunststoff