

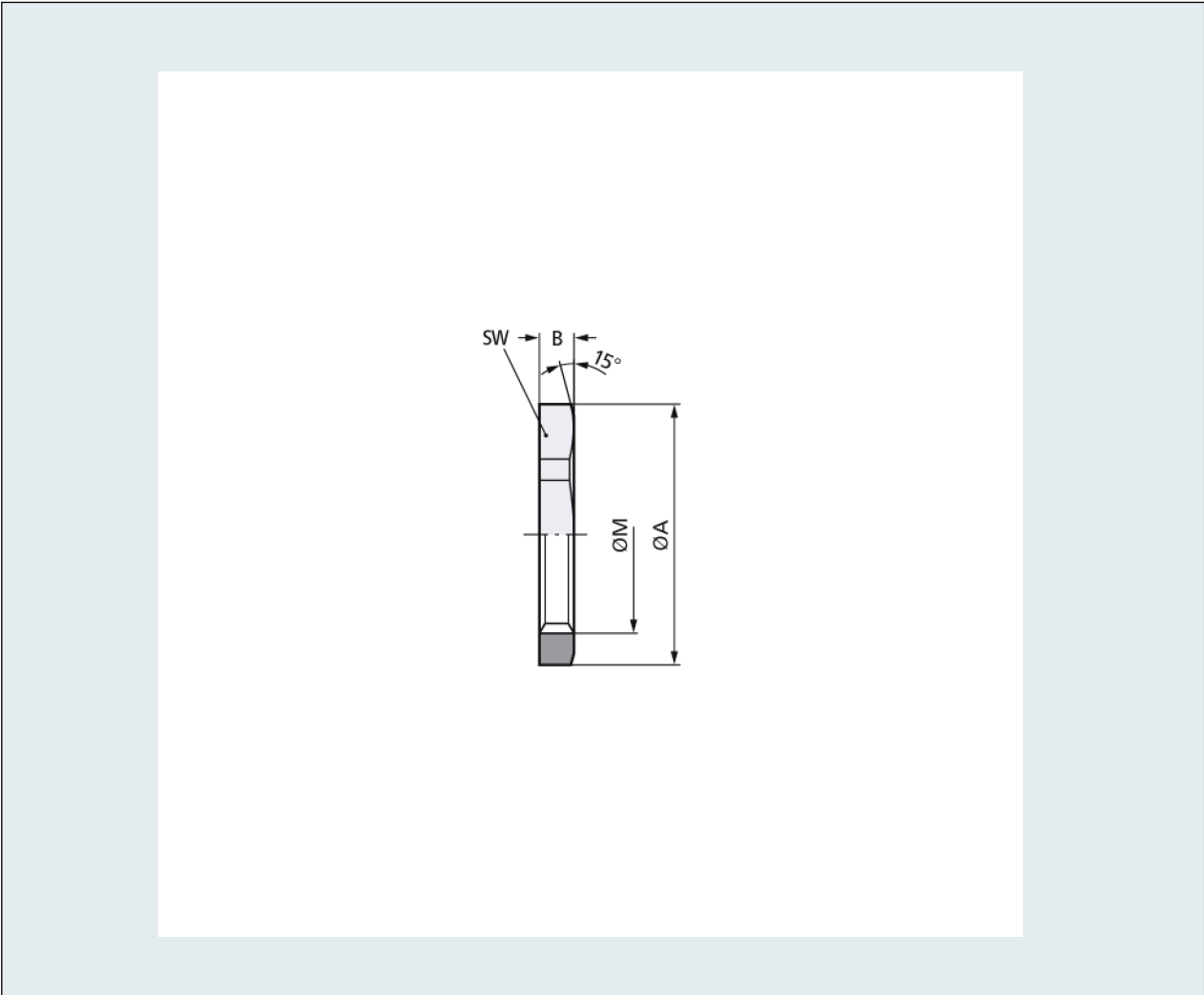

# Gegenmutter Messing SKINDICHT® SM-M

# PDF DATASHEET

© 1992 - 2010 CADENAS GmbH

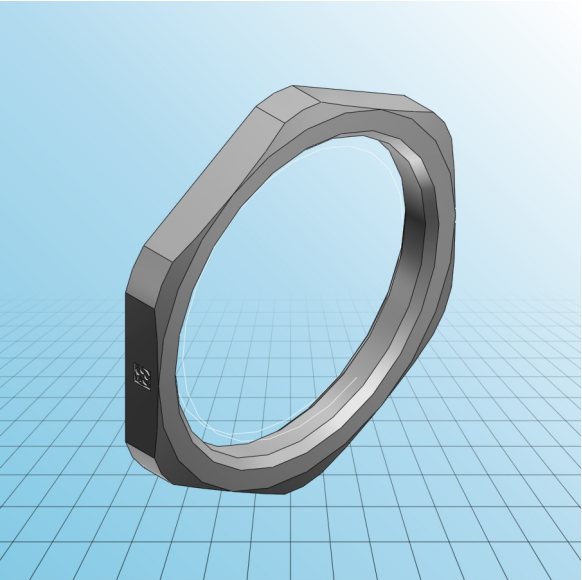



## Gegenmutter Messing SKINDICHT® SM-M

## PDF DATASHEET

© 1992 - 2010 CADENAS GmbH

<b>IDNR (Identnummer)</b>	
<b>ATN (Artikel-Nummer)</b>	52103040
<b>M (Gewinde)</b>	M 32x1,5
<b>SW (Schlüsselweite / mm)</b>	36
<b>A (Eckmass / mm)</b>	39.6
<b>B (Breite / mm)</b>	4
<b>MATERIAL (Material)</b>	Messing vernickelt