

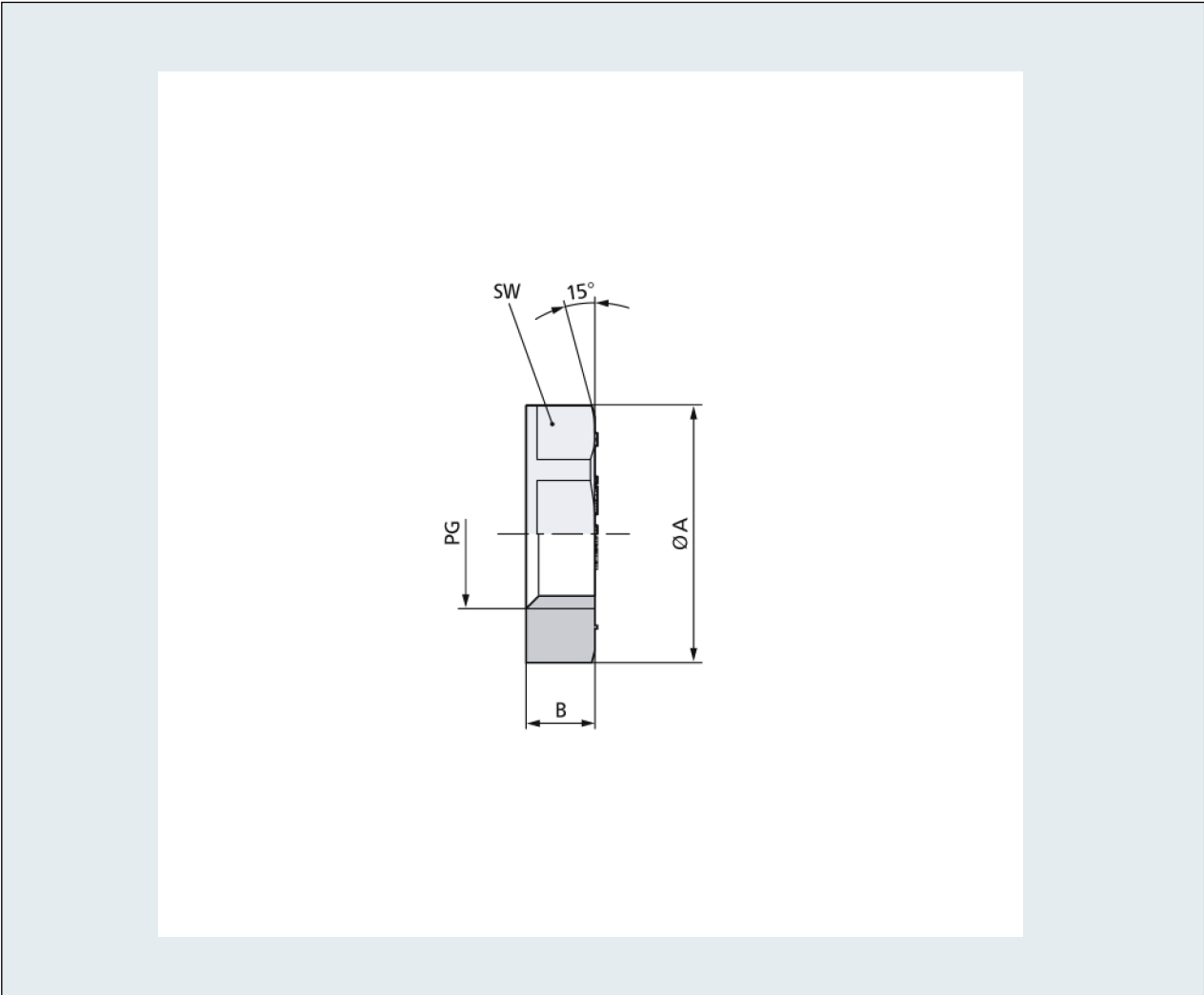

Gegenmutter Kunststoff mit GF SKINTOP® GMP-GL

PDF DATASHEET

© 1992 - 2010 CADENAS GmbH





Gegenmutter Kunststoff mit GF SKINTOP® GMP-GL

PDF DATASHEET

© 1992 - 2010 CADENAS GmbH

IDNR (Identnummer)	
ATN (Artikel-Nummer)	53019250
PG (Gewinde)	PG 21
SW (Schlüsselweite / mm)	36
A (Eckmass / mm)	39
B (mm)	7
RAL7001 (Silbergrau)	
RAL9005 (Tiefschwarz)	X
MATERIAL (Material)	Kunststoff