

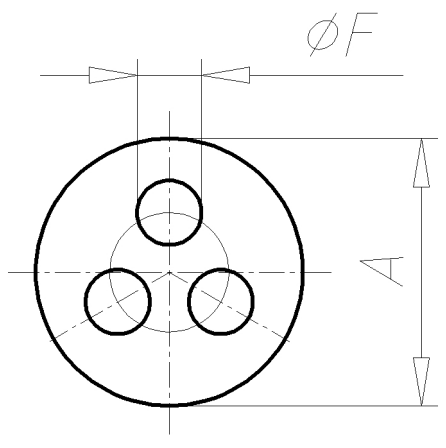

Mehrfachdichteinsatz SKINTOP® DIX-M

PDF DATASHEET

© 1992 - 2010 CADENAS GmbH

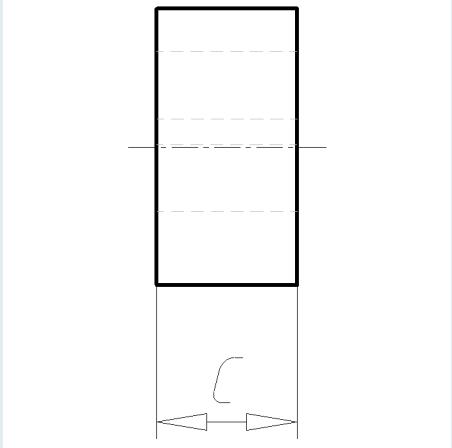
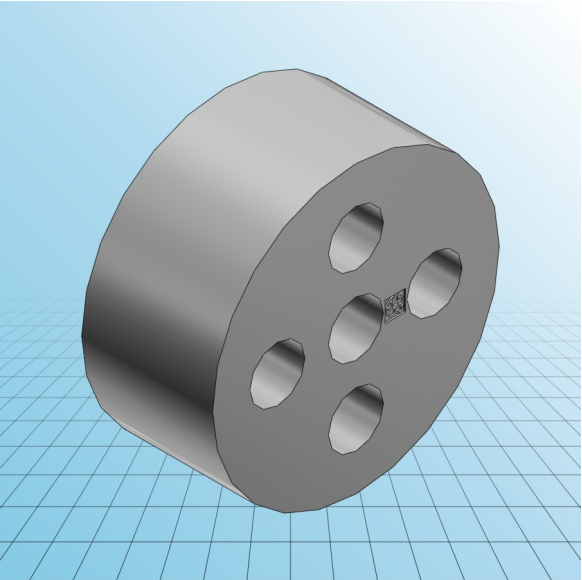



Mehrfachdichteinsatz SKINTOP® DIX-M

PDF DATASHEET

© 1992 - 2010 CADENAS GmbH

IDNR (Identnummer)	
ATN (Artikel-Nummer)	53325540
GR (Größe)	DIX-M 25
A (Ø / mm)	20.8
C (mm)	9.5
AB (Anzahl Bohrungen)	5
F (mm)	4
MATERIAL (Material)	NBR