

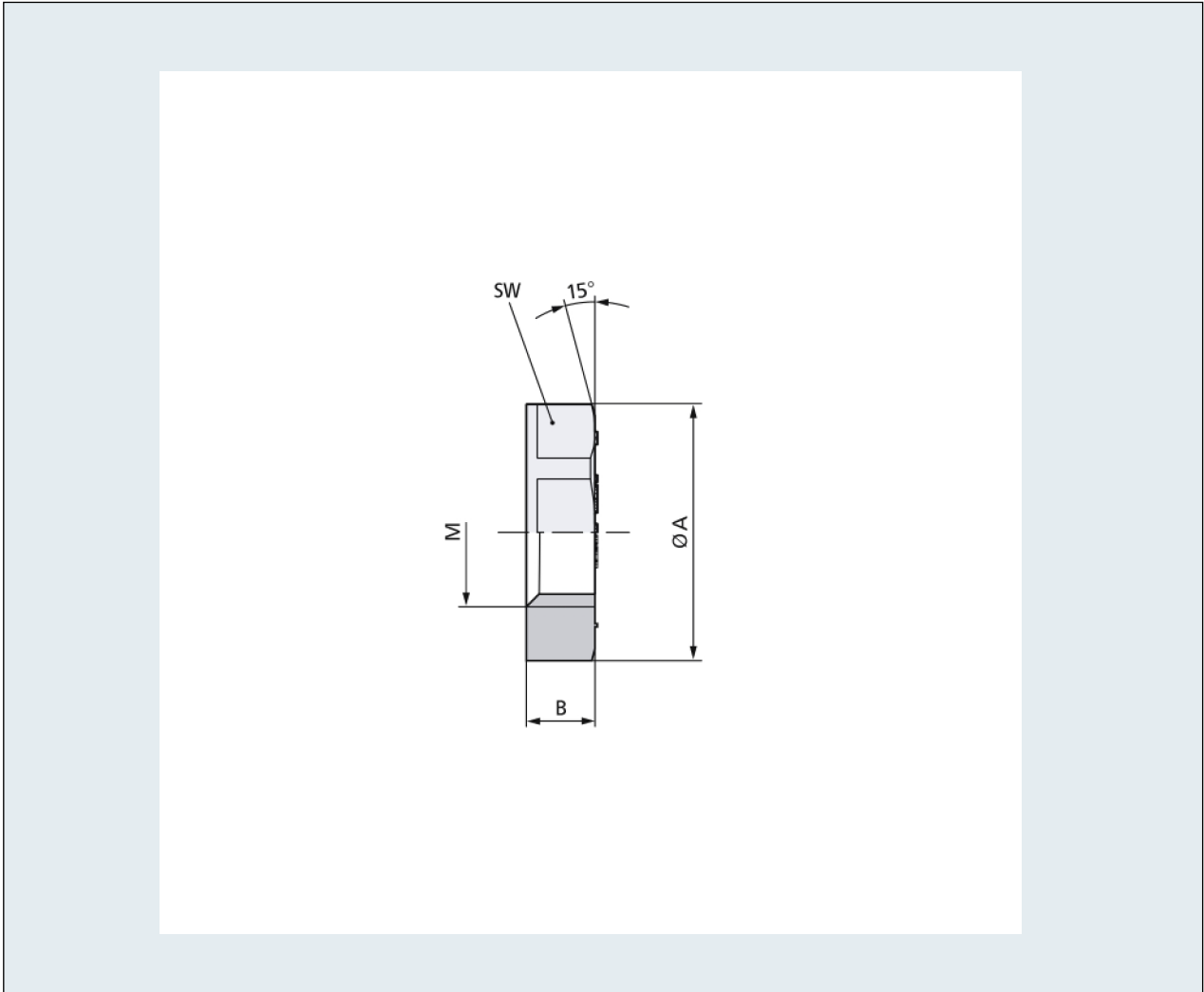

Gegenmutter Kunststoff mit GF SKINTOP® GMP-GL-M

PDF DATASHEET

© 1992 - 2010 CADENAS GmbH

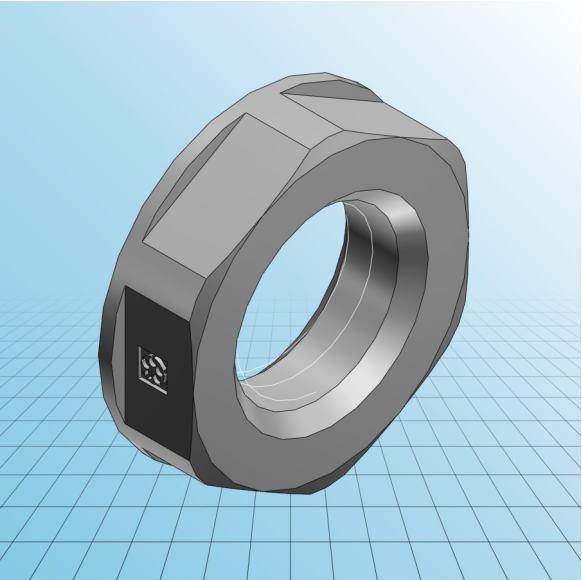



Gegenmutter Kunststoff mit GF SKINTOP® GMP-GL-M

PDF DATASHEET

© 1992 - 2010 CADENAS GmbH

IDNR (Identnummer)	
ATN (Artikel-Nummer)	53119100
M (Gewinde)	M 12x1,5
SW (Schlüsselweite / mm)	17
A (Eckmass / mm)	18.7
B (mm)	5
RAL7001 (Silbergrau)	
RAL9005 (Schwarz)	X
RAL7035 (Lichtgrau)	
MATERIAL (Material)	Kunststoff