

Product Description

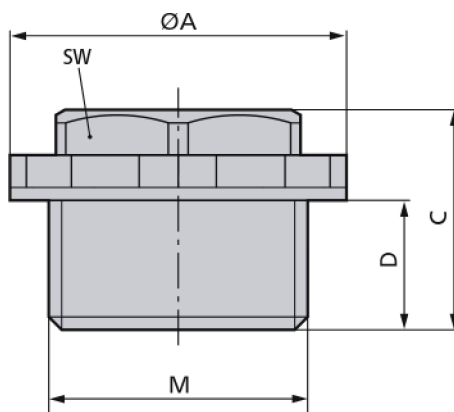

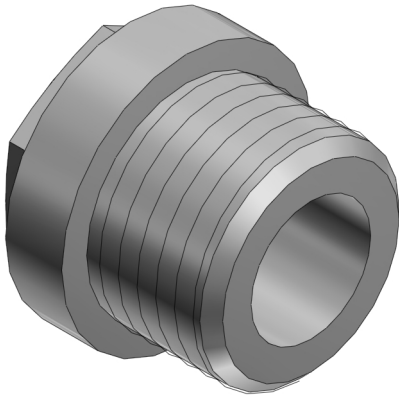

Technical Data

ATN	52020513
M	M 16x1,5
SW	15
FMIN	5
FMAX	10
F	0
A	20
C	17
D	10
MATERIAL	Kunststoff