

Product Description

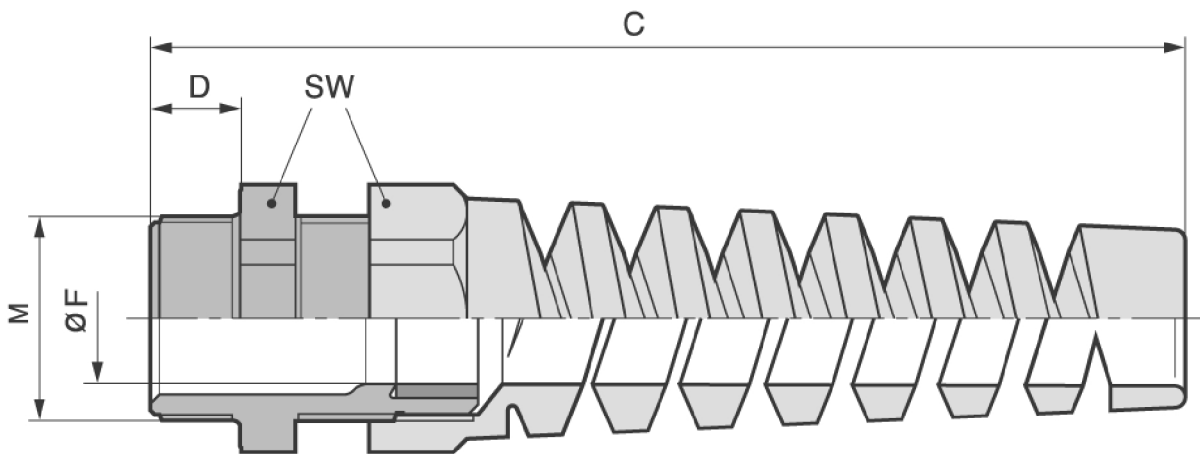

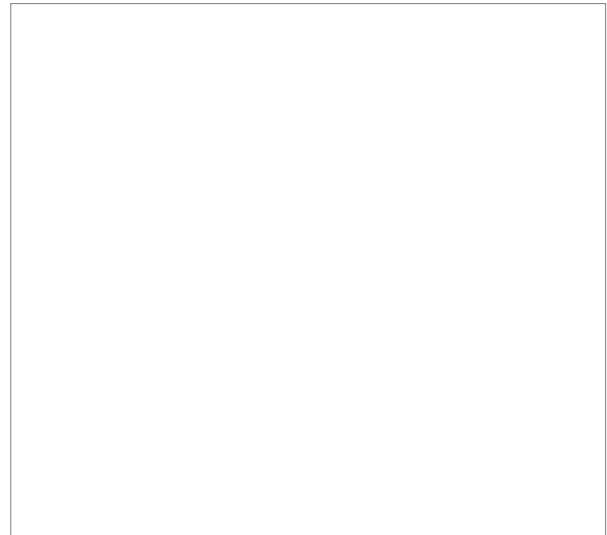
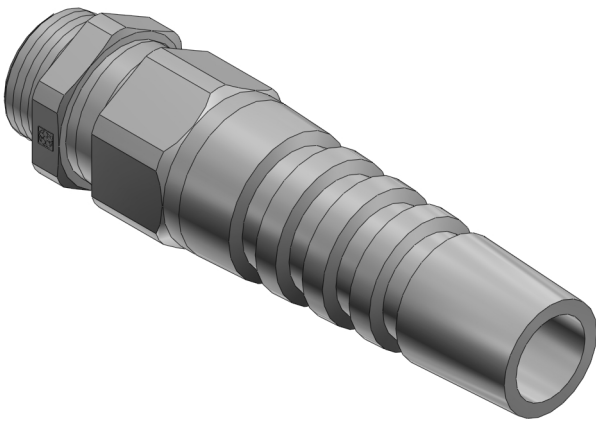

**Technical Data**

ATN	53111620
M	M 20x1,5
FMIN	7
FMAX	13
F	7
SW	25
A	27.6
C	101
D	9
RAL7001	X
RAL7035	
RAL9005	
MATERIAL	Kunststoff