

Product Description

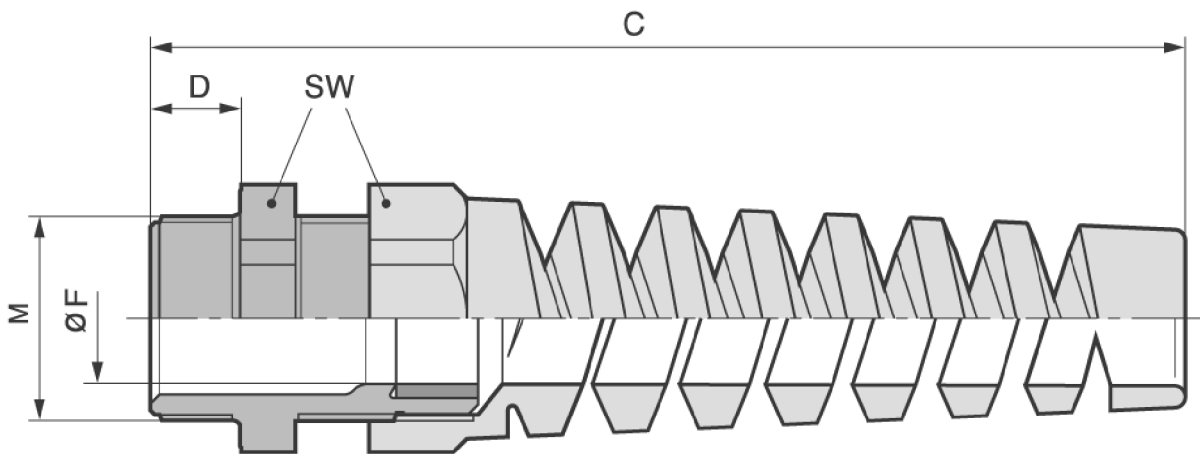

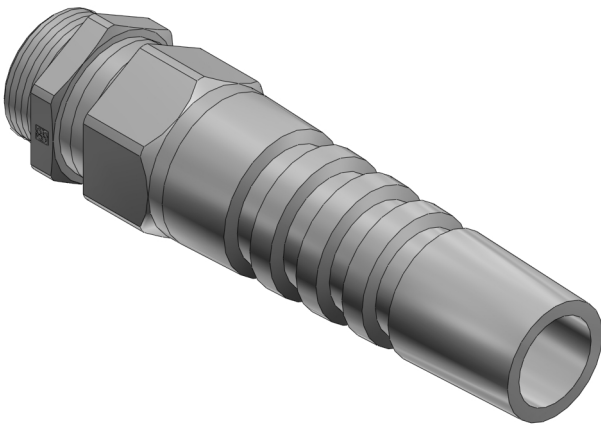

Technical Data

ATN	53111630
M	M 25x1,5
FMIN	9
FMAX	17
F	9
SW	30
A	33.9
C	125
D	10
RAL7001	X
RAL7035	
RAL9005	
MATERIAL	Kunststoff