

Product Description

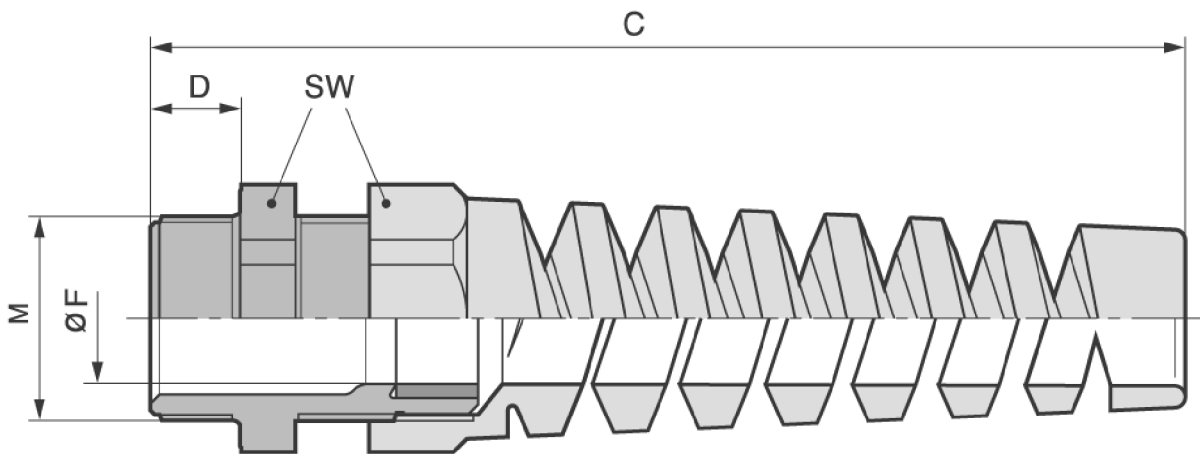

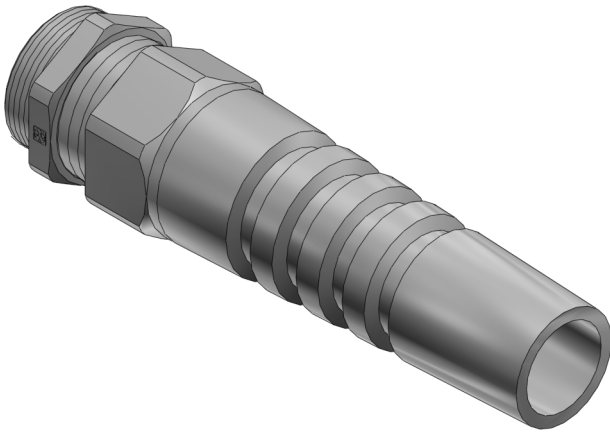

Technical Data

ATN	53111640
M	M 32x1,5
FMIN	11
FMAX	21
F	11
SW	36
A	40.2
C	149
D	10
RAL7001	X
RAL7035	
RAL9005	
MATERIAL	Kunststoff