

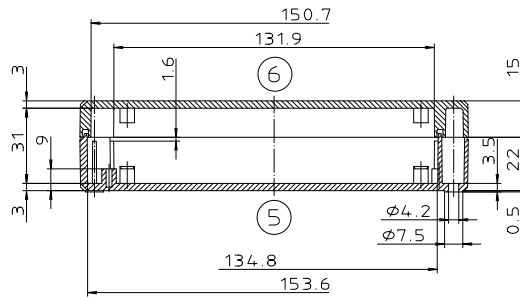

Ausführung EM/ET 229 F

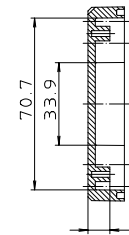

Dom 1mm abgesetzt

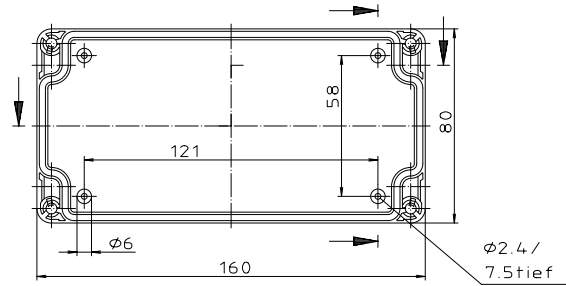
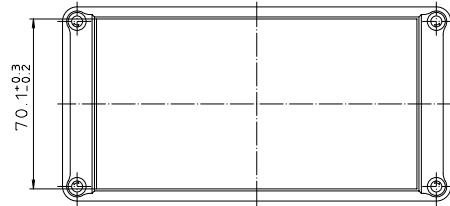
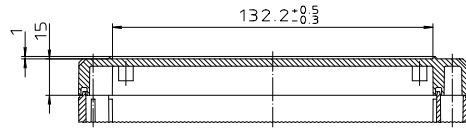
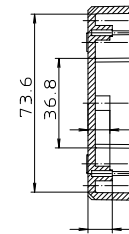
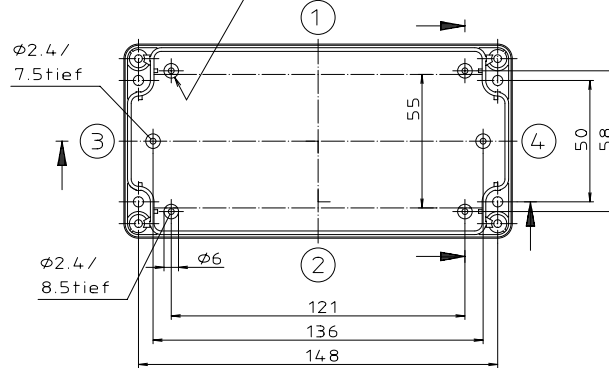

"Schutzvermerk nach DIN 31-Beschriftung"

Maßstab: 1:1			
Zchn.Nr: 1K 5145.148.02			
Artikel: EM/ET 229 EM/ET 229 F Katalogzeichnung			
3039 22.08.2002		DISK: 2 501 706	
Ar.Nr.: Datum:		Datum: 24.03.99 AK	