

RoHS Compliant

BOMcheck.net

Farbe: ■

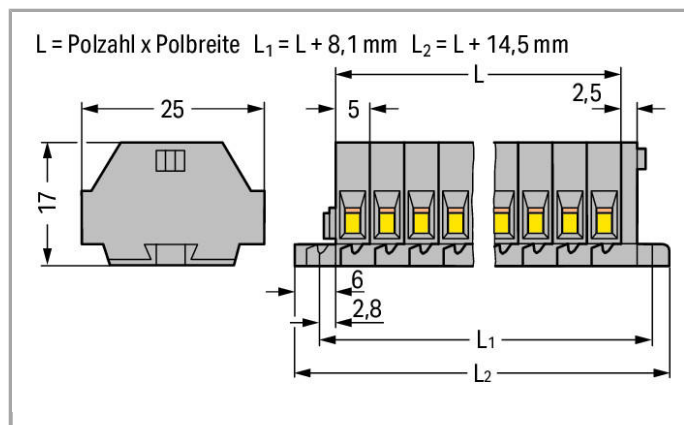

Daten

Elektrische Daten

Bemessungsdaten gemäß IEC/EN 60664-1

Bemessungsspannung (III / 3)	400 V
Bemessungsstoßspannung (III / 3)	6 kV
Bemessungsstrom	18 A
Legende Bemessungsdaten	(III / 3) ≙ Überspannungskategorie III / Verschmutzungsgrad 3

Anschlussdaten

Anschluss technik	CAGE CLAMP®
Betätigungsart	Betätigungswerkzeug
Anschließbare Leiterwerkstoffe	Kupfer Aluminium
Eindrähtiger Leiter	0,08 ... 1,5 mm ² / 28 ... 16 AWG
Feindrähtiger Leiter	0,08 ... 1,5 mm ² / 28 ... 16 AWG
Abisolierlänge	8 ... 9 mm / 0.31 ... 0.35 inch
Polzahl	11
Gesamte Anzahl der Klemmstellen	22
Gesamte Anzahl der Potentiale	11

Anzahl der Ebenen	1
Verdrahtungsart	Seitliche Verdrahtung

Geometrische Daten

Breite	69,5 mm / 2.736 inch
Höhe ab Oberfläche	17 mm / 0.669 inch
Tiefe	25 mm / 0.984 inch

Mechanische Daten

Bauform	horizontale Bauform
Befestigungsart	Befestigungsflansch
Beschriftungsebene	Seitliche Beschriftung

Werkstoffdaten

Farbe	grau
Brandlast	0.379 MJ
Gewicht	18.57 g

Kaufmännische Daten

Ursprungsland	DE
GTIN	4044918598903
Zolltarifnummer	85369010000
eCl@ss 9.0	27-14-11-06
eCl@ss 8.0	27-14-11-06
ETIM 6.0	EC001284
ETIM 5.0	EC001284

Zulassungen / Zertifikate

Länderspezifische Zulassungen

Logo	Zulassung	Zertifikatsname
	CSA DEKRA Certification B.V.	70010891
	VDE VDE Prüf- und Zertifizierungsinstitut	40033303

UL-Zulassungen

Logo	Zulassung	Zertifikatsname
------	-----------	-----------------



UR
Underwriters Laboratories Inc.

E45172

Passende Produkte

Brücker

	Art-Nr.: 260-402 Einlegebrücke; isoliert; 2-fach; reduziert den anschließbaren Querschnitt auf 1 mm	www.wago.com/260-402
--	---	--

Montage

	Art-Nr.: 209-137 Montageadapter; als Endklammer verwendbar; 6,5 mm breit	www.wago.com/209-137
--	--	--

Werkzeug

	Art-Nr.: 209-132 Betätigungswerkzeug; zum Anschließen der Einlegebrücke; 2-fach; aus Isolierstoff	www.wago.com/209-132
--	---	--

	Art-Nr.: 210-657 Betätigungswerkzeug mit teilisoliertem Schaft; Klinge (3,5 x 0,5) mm; kurz	www.wago.com/210-657
--	---	--

	Art-Nr.: 210-658 Betätigungswerkzeug mit teilisoliertem Schaft; Klinge (3,5 x 0,5) mm; kurz; abgewinkelt	www.wago.com/210-658
---	--	--

	Art-Nr.: 210-720 Betätigungswerkzeug mit teilisoliertem Schaft; Typ 2, Klinge (3,5 x 0,5) mm	www.wago.com/210-720
--	--	--

Aderendhülse

	Art-Nr.: 216-101 Aderendhülse; Hülse für 0,5 mm ² / AWG 22; ohne Kunststoffkragen; galvanisch verzinkt	www.wago.com/216-101
---	---	--

	Art-Nr.: 216-102 Aderendhülse; Hülse für 0,75 mm ² / AWG 20; ohne Kunststoffkragen; galvanisch verzinkt	www.wago.com/216-102
---	--	--

	Art-Nr.: 216-103 Aderendhülse; Hülse für 1 mm ² / AWG 18; ohne Kunststoffkragen; galvanisch verzinkt	www.wago.com/216-103
---	---	--

















	Art-Nr.: 216-104 Aderendhülse; Hülse für 1,5 mm ² / AWG 16; ohne Kunststoffkragen; galvanisch verzinkt	www.wago.com/216-104
---	---	--

	Art-Nr.: 216-121 Aderendhülse; Hülse für 0,5 mm ² / AWG 22; ohne Kunststoffkragen; galvanisch verzinkt	www.wago.com/216-121
---	---	--



	Art-Nr.: 216-122 Aderendhülse; Hülse für 0,75 mm ² / AWG 20; ohne Kunststoffkragen; galvanisch verzinkt	www.wago.com/216-122
---	--	--

	Art-Nr.: 216-123 Aderendhülse; Hülse für 1 mm ² / AWG 18; ohne Kunststoffkragen; galvanisch verzinkt	www.wago.com/216-123
---	---	--

	Art-Nr.: 216-124 Aderendhülse; Hülse für 1,5 mm ² / AWG 16; ohne Kunststoffkragen; galvanisch verzinkt	www.wago.com/216-124
---	---	--

	Art-Nr.: 216-131 Aderendhülse; Hülse für 0,25 mm ² / AWG 24; ohne Kunststoffkragen; galvanisch verzinkt	www.wago.com/216-131
	Art-Nr.: 216-132 Aderendhülse; Hülse für 0,34 mm ² / AWG 24; ohne Kunststoffkragen; galvanisch verzinkt	www.wago.com/216-132
	Art-Nr.: 216-151 Aderendhülse; Hülse für 0,25 mm ² / AWG 24; ohne Kunststoffkragen; galvanisch verzinkt	www.wago.com/216-151
	Art-Nr.: 216-152 Aderendhülse; Hülse für 0,34 mm ² / AWG 24; ohne Kunststoffkragen; galvanisch verzinkt	www.wago.com/216-152
	Art-Nr.: 216-201 Aderendhülse; Hülse für 0,5 mm ² / AWG 22; mit Kunststoffkragen; galvanisch verzinkt	www.wago.com/216-201
	Art-Nr.: 216-202 Aderendhülse; Hülse für 0,75 mm ² / AWG 20; mit Kunststoffkragen; galvanisch verzinkt	www.wago.com/216-202
	Art-Nr.: 216-203 Aderendhülse; Hülse für 1 mm ² / AWG 18; mit Kunststoffkragen; galvanisch verzinkt	www.wago.com/216-203
	Art-Nr.: 216-204 Aderendhülse; Hülse für 1,5 mm ² / AWG 16; mit Kunststoffkragen; galvanisch verzinkt	www.wago.com/216-204
	Art-Nr.: 216-221 Aderendhülse; Hülse für 0,5 mm ² / AWG 22; mit Kunststoffkragen; galvanisch verzinkt	www.wago.com/216-221
	Art-Nr.: 216-222 Aderendhülse; Hülse für 0,75 mm ² / AWG 20; mit Kunststoffkragen; galvanisch verzinkt	www.wago.com/216-222
	Art-Nr.: 216-223 Aderendhülse; Hülse für 1 mm ² / AWG 18; mit Kunststoffkragen; galvanisch verzinkt	www.wago.com/216-223
	Art-Nr.: 216-224 Aderendhülse; Hülse für 1,5 mm ² / AWG 16; mit Kunststoffkragen; galvanisch verzinkt	www.wago.com/216-224
	Art-Nr.: 216-301 Aderendhülse; Hülse für 0,25 mm ² / AWG 24; mit Kunststoffkragen; galvanisch verzinkt	www.wago.com/216-301
	Art-Nr.: 216-302 Aderendhülse; Hülse für 0,34 mm ² / AWG 24; mit Kunststoffkragen; galvanisch verzinkt	www.wago.com/216-302
	Art-Nr.: 216-321 Aderendhülse; Hülse für 0,25 mm ² / AWG 24; mit Kunststoffkragen; galvanisch verzinkt	www.wago.com/216-321
	Art-Nr.: 216-322 Aderendhülse; Hülse für 0,34 mm ² / AWG 24; mit Kunststoffkragen; galvanisch verzinkt	www.wago.com/216-322

Prüfen und Messen

	Art-Nr.: 210-136 Prüfstecker; Ø 2 mm; mit 500mm-Leitung	www.wago.com/210-136
	Art-Nr.: 210-137 Prüfstecker; Ø 2,3 mm; mit 500mm-Leitung	www.wago.com/210-137
	Art-Nr.: 249-135 Prüfsteckermodul; ohne Rastklinken; anreihbar; für 2-Leiter-Klemmen	www.wago.com/249-135



Art-Nr.: 260-404

Prüfsteckermodul; mit Rastklinken; anreihbar; für 2-Leiter-Klemmen; für Serie 260

www.wago.com/260-404

Allgemeines Zubehör



Art-Nr.: 209-123

Montagefuß mit Schraube; an Klemmen mit Befestigungsflansch anschraubbar; 6,4 mm breit

www.wago.com/209-123

Downloads

Dokumentation

Ausschreibungstext

260-111	Oct 10, 2017	DOC 24,6 kB	Download
---------	--------------	----------------	----------

smartDATA

CAD Daten

3D Download 260-111	URL	Download
---------------------	-----	----------

Änderungen vorbehalten.