

Product Description

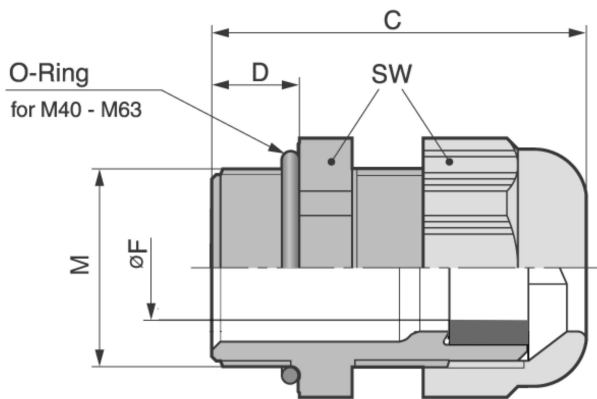

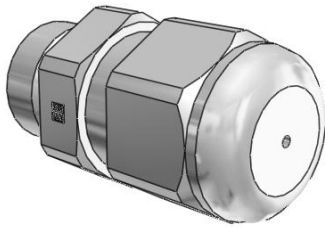

Technical Data

ATN	53111500
M	M 12x1,5
FMIN	1
FMAX	5
F	1
SW	15
A	16.6
C	30
D	8
RAL7001	
RAL7035	X
RAL9005	
MATERIAL	Kunststoff