

Product Description

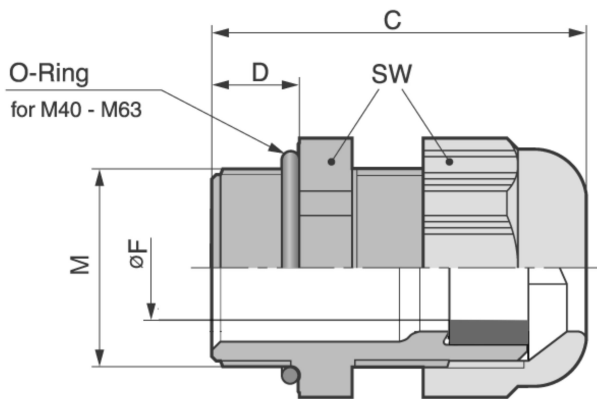

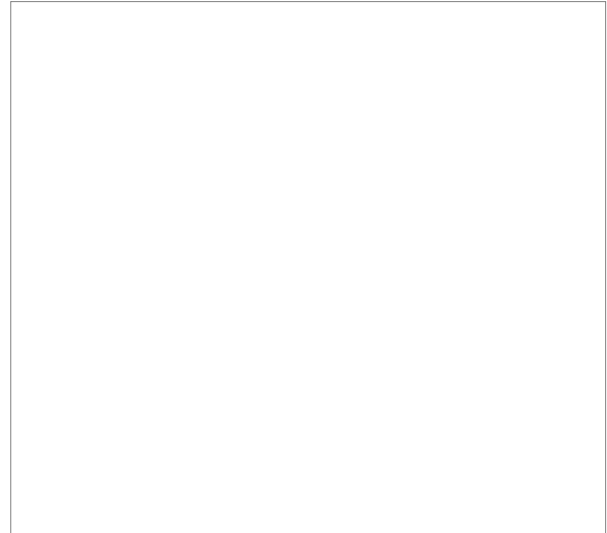
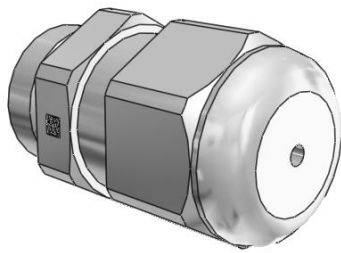

Technical Data

ATN	53111510
M	M 16x1,5
FMIN	2
FMAX	7
F	2
SW	19
A	21.1
C	34
D	8
RAL7001	
RAL7035	X
RAL9005	
MATERIAL	Kunststoff