

Product Description

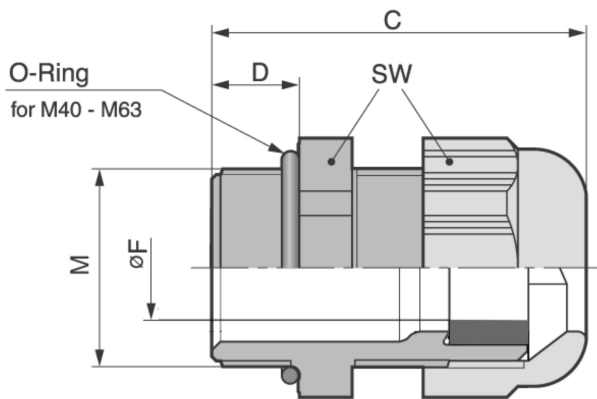

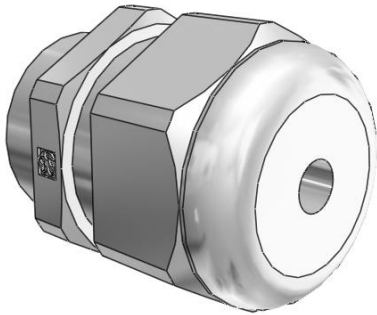

Technical Data

ATN	53111130
M	M 25x1,5
FMIN	6
FMAX	13
F	6
SW	30
A	33.4
C	40
D	10
RAL7001	X
RAL7035	
RAL9005	
MATERIAL	Kunststoff