

Product Description

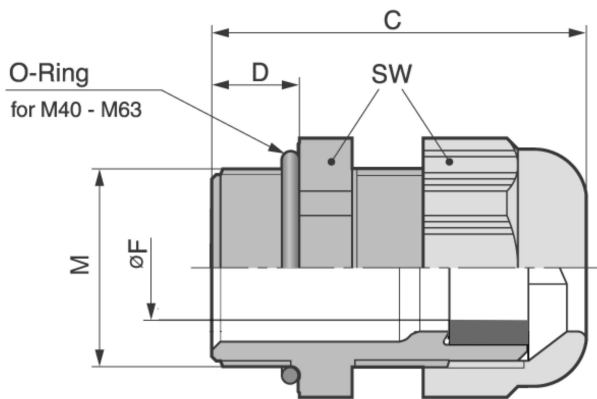

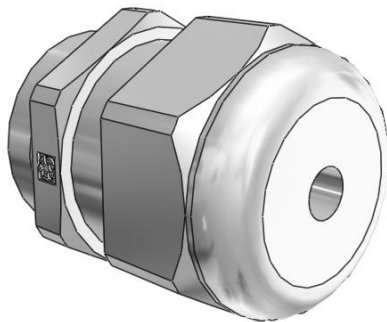

Technical Data

ATN	53111540
M	M 32x1,5
FMIN	7
FMAX	15
F	7
SW	36
A	40.3
C	47
D	10
RAL7001	
RAL7035	X
RAL9005	
MATERIAL	Kunststoff