

Product Description

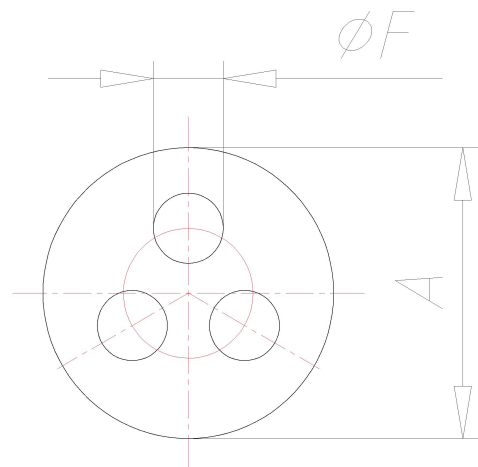

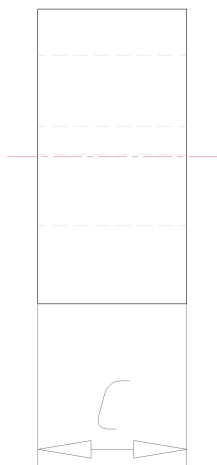
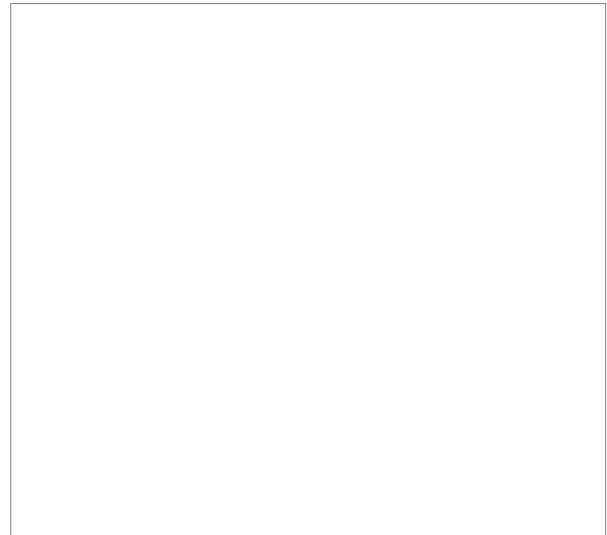

**Technical Data**

ATN	53320260
GR	DIX-M 20
A	16.6
C	8.4
AB	2
F	6
MATERIAL	NBR