

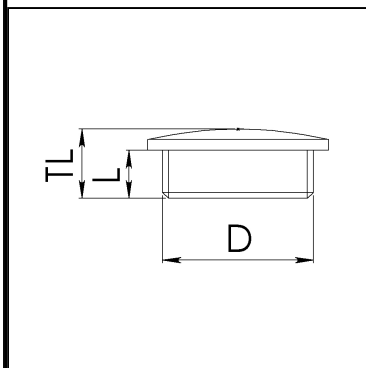





Verschlusschrauben, metrisch



Schutzart gemäß EN 60 529: IP 56, bei Montage mit Anschlussgewindedichtring IP 68
Einsatztemperatur: -40°C bis 100°C, kurzzeitig bis ca. 150°C
Material: Polyamid, glasfaserverstärkt
Ausstattung: Zum sicheren Verschließen von nicht genutzten Gewinde- oder Durchgangslöchern
Chemische Beständigkeit: Aceton, Benzin, Benzol, Dieselöl, Fette, Öle, Lösungsmittel für Farben und Lacke
Spannungsrissegefahr: Niedrig

Type	WISKA-No. RAL 7035	WISKA-No. RAL 9005	WISKA-No. RAL 7001		 mm	 mm	 Nm	 ISO 4757	 mm	E1 mm
EVSG 12	60624	61830	62514	100/1000	M 12x1,5	6	0,5	Z3	9x1,4	15
EVSG 16	60625	61831	62515	100/1000	M 16x1,5	6	0,5	Z3	9x1,4	20
EVSG 20	60626	61832	62516	100/1000	M 20x1,5	6	1,0	Z3	9x1,4	24
EVSG 25	60627	61833	62517	100/1000	M 25x1,5	8	1,0	Z3	9x1,4	30
EVSG 32	60628	61834	62518	100/1000	M 32x1,5	8	1,0	Z4	13x2	37
EVSG 40	60629	61835	62519	50	M 40x1,5	8	2,0	Z4	13x2	46
EVSG 50	60630	61836	62520	50	M 50x1,5	10	2,0	Z4	13x2	56
EVSG 63	60631	61837	62521	25	M 63x1,5	12	2,5	Z4	13x2	70