

RoHS  Compliant

BOMcheck.net

Farbe: ■

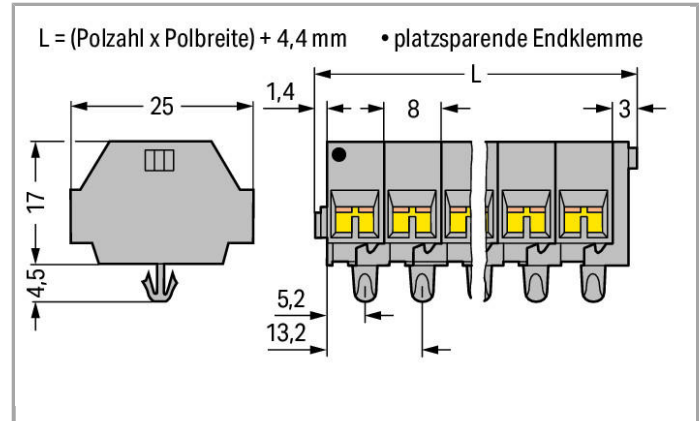

## Daten

### Elektrische Daten

#### Bemessungsdaten gemäß IEC/EN 60664-1

Bemessungsspannung (III / 3)	400 V
Bemessungsstoßspannung (III / 3)	6 kV
Bemessungsstrom	18 A
Legende Bemessungsdaten	(III / 3) $\triangleq$ Überspannungskategorie III / Verschmutzungsgrad 3

### Anschlussdaten

Anschluss technik	CAGE CLAMP®
Betätigungsart	Betätigungswerkzeug
Anschließbare Leiterwerkstoffe	Kupfer Aluminium
Eindrähtiger Leiter	0,08 ... 1,5 mm <sup>2</sup> / 28 ... 16 AWG
Feindrähtiger Leiter	0,08 ... 1,5 mm <sup>2</sup> / 28 ... 16 AWG
Abisolierlänge	8 ... 9 mm / 0.31 ... 0.35 inch
Polzahl	2
Gesamte Anzahl der Klemmstellen	8
Gesamte Anzahl der Potentiale	2

Anzahl der Ebenen	1
Verdrahtungsart	Seitliche Verdrahtung

### Geometrische Daten

Breite	20,4 mm / 0.803 inch
Höhe ab Oberfläche	17 mm / 0.669 inch
Tiefe	25 mm / 0.984 inch

### Mechanische Daten

Bauform	horizontale Bauform
Befestigungsart	Rastfuß
Beschriftungsebene	Seitliche Beschriftung

### Werkstoffdaten

Farbe	grau
Brandlast	0.108 MJ
Gewicht	5 g

### Kaufmännische Daten

Ursprungsland	DE
GTIN	4044918604222
Zolltarifnummer	85369010000
eCl@ss 9.0	27-14-11-06
eCl@ss 8.0	27-14-11-06
ETIM 6.0	EC001284
ETIM 5.0	EC001284

### Zulassungen / Zertifikate

#### Länderspezifische Zulassungen

Logo	Zulassung	Zertifikatsname
	<b>CSA</b> DEKRA Certification B.V.	70010891
	<b>VDE</b> VDE Prüf- und Zertifizierungsinstitut	40033303

#### Schiff Zulassungen

Logo	Zulassung	Zertifikatsname
------	-----------	-----------------



DNV GL  
Det Norske Veritas, Germanischer Lloyd





TAE00001V2

### UL-Zulassungen





Logo	Zulassung	Zertifikatsname
	UR Underwriters Laboratories Inc.	E45172

### Passende Produkte





#### Werkzeug





















	<b>Art-Nr.: 209-132</b> Betätigungswerkzeug; zum Anschließen der Einlegebrücke; 2-fach; aus Isolierstoff	<a href="http://www.wago.com/209-132">www.wago.com/209-132</a>
	<b>Art-Nr.: 210-657</b> Betätigungswerkzeug mit teilisoliertem Schaft; Klinge (3,5 x 0,5) mm; kurz	<a href="http://www.wago.com/210-657">www.wago.com/210-657</a>
	<b>Art-Nr.: 210-658</b> Betätigungswerkzeug mit teilisoliertem Schaft; Klinge (3,5 x 0,5) mm; kurz; abgewinkelt	<a href="http://www.wago.com/210-658">www.wago.com/210-658</a>
	<b>Art-Nr.: 210-720</b> Betätigungswerkzeug mit teilisoliertem Schaft; Typ 2, Klinge (3,5 x 0,5) mm	<a href="http://www.wago.com/210-720">www.wago.com/210-720</a>

#### Prüfen und Messen

	<b>Art-Nr.: 210-136</b> Prüfstecker; Ø 2 mm; mit 500mm-Leitung	<a href="http://www.wago.com/210-136">www.wago.com/210-136</a>
	<b>Art-Nr.: 210-137</b> Prüfstecker; Ø 2,3 mm; mit 500mm-Leitung	<a href="http://www.wago.com/210-137">www.wago.com/210-137</a>
	<b>Art-Nr.: 249-138</b> Prüfsteckermodul; ohne Rastklinken; anreihbar; für 4-Leiter-Klemmen	<a href="http://www.wago.com/249-138">www.wago.com/249-138</a>
	<b>Art-Nr.: 260-405</b> Prüfsteckermodul; mit Rastklinken; anreihbar; für 4-Leiter-Klemmen; für Serie 260	<a href="http://www.wago.com/260-405">www.wago.com/260-405</a>

#### Aderendhülse

	<b>Art-Nr.: 216-101</b> Aderendhülse; Hülse für 0,5 mm <sup>2</sup> / AWG 22; ohne Kunststoffkragen; galvanisch verzinkt	<a href="http://www.wago.com/216-101">www.wago.com/216-101</a>
	<b>Art-Nr.: 216-102</b> Aderendhülse; Hülse für 0,75 mm <sup>2</sup> / AWG 20; ohne Kunststoffkragen; galvanisch verzinkt	<a href="http://www.wago.com/216-102">www.wago.com/216-102</a>
	<b>Art-Nr.: 216-103</b> Aderendhülse; Hülse für 1 mm <sup>2</sup> / AWG 18; ohne Kunststoffkragen; galvanisch verzinkt	<a href="http://www.wago.com/216-103">www.wago.com/216-103</a>
	<b>Art-Nr.: 216-104</b> Aderendhülse; Hülse für 1,5 mm <sup>2</sup> / AWG 16; ohne Kunststoffkragen; galvanisch verzinkt	<a href="http://www.wago.com/216-104">www.wago.com/216-104</a>

	<b>Art-Nr.: 216-121</b> Aderendhülse; Hülse für 0,5 mm <sup>2</sup> / AWG 22; ohne Kunststoffkragen; galvanisch verzinkt	<a href="http://www.wago.com/216-121">www.wago.com/216-121</a>
	<b>Art-Nr.: 216-122</b> Aderendhülse; Hülse für 0,75 mm <sup>2</sup> / AWG 20; ohne Kunststoffkragen; galvanisch verzinkt	<a href="http://www.wago.com/216-122">www.wago.com/216-122</a>
	<b>Art-Nr.: 216-123</b> Aderendhülse; Hülse für 1 mm <sup>2</sup> / AWG 18; ohne Kunststoffkragen; galvanisch verzinkt	<a href="http://www.wago.com/216-123">www.wago.com/216-123</a>
	<b>Art-Nr.: 216-124</b> Aderendhülse; Hülse für 1,5 mm <sup>2</sup> / AWG 16; ohne Kunststoffkragen; galvanisch verzinkt	<a href="http://www.wago.com/216-124">www.wago.com/216-124</a>
	<b>Art-Nr.: 216-131</b> Aderendhülse; Hülse für 0,25 mm <sup>2</sup> / AWG 24; ohne Kunststoffkragen; galvanisch verzinkt	<a href="http://www.wago.com/216-131">www.wago.com/216-131</a>
	<b>Art-Nr.: 216-132</b> Aderendhülse; Hülse für 0,34 mm <sup>2</sup> / AWG 24; ohne Kunststoffkragen; galvanisch verzinkt	<a href="http://www.wago.com/216-132">www.wago.com/216-132</a>
	<b>Art-Nr.: 216-151</b> Aderendhülse; Hülse für 0,25 mm <sup>2</sup> / AWG 24; ohne Kunststoffkragen; galvanisch verzinkt	<a href="http://www.wago.com/216-151">www.wago.com/216-151</a>
	<b>Art-Nr.: 216-152</b> Aderendhülse; Hülse für 0,34 mm <sup>2</sup> / AWG 24; ohne Kunststoffkragen; galvanisch verzinkt	<a href="http://www.wago.com/216-152">www.wago.com/216-152</a>
	<b>Art-Nr.: 216-201</b> Aderendhülse; Hülse für 0,5 mm <sup>2</sup> / AWG 22; mit Kunststoffkragen; galvanisch verzinkt	<a href="http://www.wago.com/216-201">www.wago.com/216-201</a>
	<b>Art-Nr.: 216-202</b> Aderendhülse; Hülse für 0,75 mm <sup>2</sup> / AWG 20; mit Kunststoffkragen; galvanisch verzinkt	<a href="http://www.wago.com/216-202">www.wago.com/216-202</a>
	<b>Art-Nr.: 216-203</b> Aderendhülse; Hülse für 1 mm <sup>2</sup> / AWG 18; mit Kunststoffkragen; galvanisch verzinkt	<a href="http://www.wago.com/216-203">www.wago.com/216-203</a>
	<b>Art-Nr.: 216-204</b> Aderendhülse; Hülse für 1,5 mm <sup>2</sup> / AWG 16; mit Kunststoffkragen; galvanisch verzinkt	<a href="http://www.wago.com/216-204">www.wago.com/216-204</a>
	<b>Art-Nr.: 216-221</b> Aderendhülse; Hülse für 0,5 mm <sup>2</sup> / AWG 22; mit Kunststoffkragen; galvanisch verzinkt	<a href="http://www.wago.com/216-221">www.wago.com/216-221</a>
	<b>Art-Nr.: 216-222</b> Aderendhülse; Hülse für 0,75 mm <sup>2</sup> / AWG 20; mit Kunststoffkragen; galvanisch verzinkt	<a href="http://www.wago.com/216-222">www.wago.com/216-222</a>
	<b>Art-Nr.: 216-223</b> Aderendhülse; Hülse für 1 mm <sup>2</sup> / AWG 18; mit Kunststoffkragen; galvanisch verzinkt	<a href="http://www.wago.com/216-223">www.wago.com/216-223</a>
	<b>Art-Nr.: 216-224</b> Aderendhülse; Hülse für 1,5 mm <sup>2</sup> / AWG 16; mit Kunststoffkragen; galvanisch verzinkt	<a href="http://www.wago.com/216-224">www.wago.com/216-224</a>
	<b>Art-Nr.: 216-301</b> Aderendhülse; Hülse für 0,25 mm <sup>2</sup> / AWG 24; mit Kunststoffkragen; galvanisch verzinkt	<a href="http://www.wago.com/216-301">www.wago.com/216-301</a>
	<b>Art-Nr.: 216-302</b> Aderendhülse; Hülse für 0,34 mm <sup>2</sup> / AWG 24; mit Kunststoffkragen; galvanisch verzinkt	<a href="http://www.wago.com/216-302">www.wago.com/216-302</a>
	<b>Art-Nr.: 216-321</b> Aderendhülse; Hülse für 0,25 mm <sup>2</sup> / AWG 24; mit Kunststoffkragen; galvanisch verzinkt	<a href="http://www.wago.com/216-321">www.wago.com/216-321</a>
	<b>Art-Nr.: 216-322</b> Aderendhülse; Hülse für 0,34 mm <sup>2</sup> / AWG 24; mit Kunststoffkragen; galvanisch verzinkt	<a href="http://www.wago.com/216-322">www.wago.com/216-322</a>

### Tragschiene

	<b>Art-Nr.: 210-154</b> Aluminiumtragschiene; 1000 mm lang; 18 mm breit; 7 mm hoch	<a href="http://www.wago.com/210-154">www.wago.com/210-154</a>
--	---	--

### Brücker

	<b>Art-Nr.: 260-402</b> Einlegebrücke; isoliert; 2-fach; reduziert den anschließbaren Querschnitt auf 1 mm	<a href="http://www.wago.com/260-402">www.wago.com/260-402</a>
--	---	--

### Allgemeines Zubehör

	<b>Art-Nr.: 209-122</b> Kunststoffendklammer; mit WSB beschriftbar; für Alu-Schiene 210-154	<a href="http://www.wago.com/209-122">www.wago.com/209-122</a>
--	--	--

### Montage

	<b>Art-Nr.: 209-120</b> Montagefuß; an Klemmen mit Rastfuß anrastbar; zum Anschrauben an die Relaisbausteine; 6,4 mm breit	<a href="http://www.wago.com/209-120">www.wago.com/209-120</a>
--	---	--

	<b>Art-Nr.: 209-137</b> Montageadapter; als Endklammer verwendbar; 6,5 mm breit	<a href="http://www.wago.com/209-137">www.wago.com/209-137</a>
--	--	--

### Downloads

#### Dokumentation

#### Ausschreibungstext

260-252	Oct 10, 2017	DOC 24,6 kB	Download
---------	--------------	----------------	----------

### smartDATA

#### CAD Daten

3D Download 260-252	URL	Download
---------------------	-----	----------

Änderungen vorbehalten.