

Datenblatt | Artikelnummer: 261-212

4-Leiter-Klemmenleiste; mit Befestigungsflanschen; für Schraub- u.ä.
Befestigungsarten; Befestigungsloch Ø 3,2 mm; mit Montagefuß 209-123
auch auf TS 35; 12-polig

www.wago.com/261-212

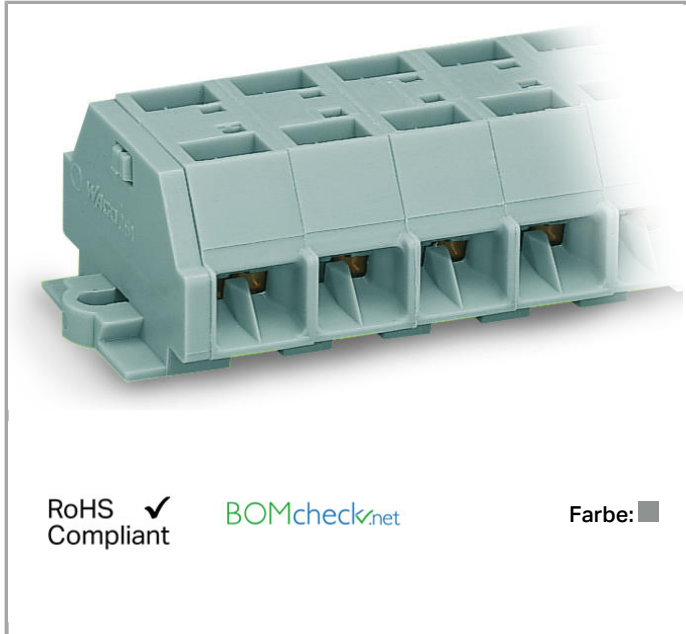

RoHS
Compliant

Farbe:

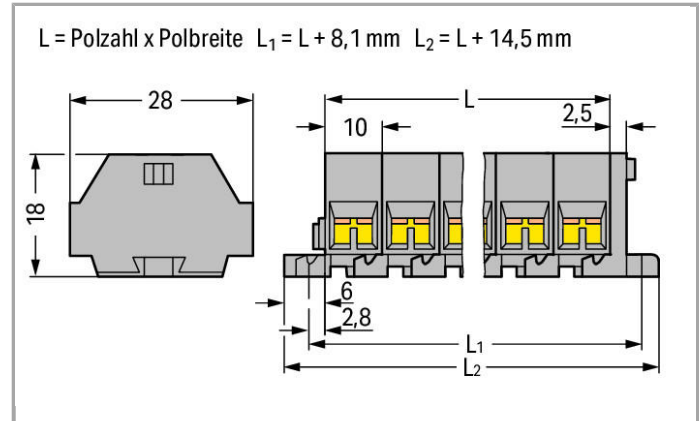

Daten

Elektrische Daten

Bemessungsdaten gemäß IEC/EN 60664-1

| | |
|----------------------------------|---|
| Bemessungsspannung (III / 3) | 500 V |
| Bemessungsstoßspannung (III / 3) | 6 kV |
| Bemessungsstrom | 24 A |
| Legende Bemessungsdaten | (III / 3) ≙ Überspannungskategorie III / Verschmutzungsgrad 3 |

Anschlussdaten

| | |
|---------------------------------|--|
| Anschlusstechnik | CAGE CLAMP® |
| Betätigungsart | Betätigungswerkzeug |
| Anschließbare Leiterwerkstoffe | Kupfer Aluminium |
| Eindrähtiger Leiter | 0,08 ... 2,5 mm ² / 28 ... 14 AWG |
| Feindrähtiger Leiter | 0,08 ... 2,5 mm ² / 28 ... 14 AWG |
| Abisolierlänge | 8 ... 9 mm / 0.31 ... 0.35 inch |
| Polzahl | 12 |
| Gesamte Anzahl der Klemmstellen | 48 |
| Gesamte Anzahl der Potentiale | 12 |

| | |
|-------------------|-----------------------|
| Anzahl der Ebenen | 1 |
| Verdrahtungsart | Seitliche Verdrahtung |

Geometrische Daten

| | |
|--------------------|-----------------------|
| Breite | 134,5 mm / 5.295 inch |
| Höhe ab Oberfläche | 18 mm / 0.709 inch |
| Tiefe | 28 mm / 1.102 inch |

Mechanische Daten

| | |
|--------------------|------------------------|
| Bauform | horizontale Bauform |
| Befestigungsart | Befestigungsflansch |
| Beschriftungsebene | Seitliche Beschriftung |

Werkstoffdaten



| | |
|-----------|----------|
| Farbe | grau |
| Brandlast | 0.753 MJ |
| Gewicht | 47.23 g |

Kaufmännische Daten





| | |
|-----------------|---------------|
| Ursprungsland | DE |
| GTIN | 4044918612333 |
| Zolltarifnummer | 85369010000 |
| eCl@ss 9.0 | 27-14-11-06 |
| eCl@ss 8.0 | 27-14-11-06 |
| ETIM 6.0 | EC001284 |
| ETIM 5.0 | EC001284 |

Zulassungen / Zertifikate

Länderspezifische Zulassungen

| Logo | Zulassung | Zertifikatsname |
|--|---------------------------------|-----------------|
|  | CCA DEKRA Certification B.V. | NTR-NL 6509 |
|  | CCA DEKRA Certification B.V. | 2110272.02 |
|  | CSA DEKRA Certification B.V. | 70010891 |

Schiff Zulassungen

| Logo | Zulassung | Zertifikatsname |
|--|---|------------------|
|  | ABS American Bureau of Shipping | 14-HG1241539-PDA |
|  | BV Bureau Veritas S.A. | 07436/E0 BV |
|  | LR Lloyds Register | 91/20242(E6) |
|  | LR Lloyds Register | 91/20242 (E7) |





















UL-Zulassungen

| Logo | Zulassung | Zertifikatsname |
|--|---|-----------------|
|  | UR Underwriters Laboratories Inc. | E45172 s.6 |

Passende Produkte

Aderendhülse

| | | |
|--|--|--|
|  | Art-Nr.: 216-101 Aderendhülse; Hülse für 0,5 mm ² / AWG 22; ohne Kunststoffkragen; galvanisch verzinkt | www.wago.com/216-101 |
|  | Art-Nr.: 216-102 Aderendhülse; Hülse für 0,75 mm ² / AWG 20; ohne Kunststoffkragen; galvanisch verzinkt | www.wago.com/216-102 |
|  | Art-Nr.: 216-103 Aderendhülse; Hülse für 1 mm ² / AWG 18; ohne Kunststoffkragen; galvanisch verzinkt | www.wago.com/216-103 |
|  | Art-Nr.: 216-104 Aderendhülse; Hülse für 1,5 mm ² / AWG 16; ohne Kunststoffkragen; galvanisch verzinkt | www.wago.com/216-104 |
|  | Art-Nr.: 216-106 Aderendhülse; Hülse für 2,5 mm ² / AWG 14; ohne Kunststoffkragen; galvanisch verzinkt | www.wago.com/216-106 |
|  | Art-Nr.: 216-121 Aderendhülse; Hülse für 0,5 mm ² / AWG 22; ohne Kunststoffkragen; galvanisch verzinkt | www.wago.com/216-121 |
|  | Art-Nr.: 216-122 Aderendhülse; Hülse für 0,75 mm ² / AWG 20; ohne Kunststoffkragen; galvanisch verzinkt | www.wago.com/216-122 |

| | | |
|--|--|--|
|  | Art-Nr.: 216-123 Aderendhülse; Hülse für 1 mm ² / AWG 18; ohne Kunststoffkragen; galvanisch verzinkt | www.wago.com/216-123 |
|  | Art-Nr.: 216-124 Aderendhülse; Hülse für 1,5 mm ² / AWG 16; ohne Kunststoffkragen; galvanisch verzinkt | www.wago.com/216-124 |
|  | Art-Nr.: 216-131 Aderendhülse; Hülse für 0,25 mm ² / AWG 24; ohne Kunststoffkragen; galvanisch verzinkt | www.wago.com/216-131 |
|  | Art-Nr.: 216-132 Aderendhülse; Hülse für 0,34 mm ² / AWG 24; ohne Kunststoffkragen; galvanisch verzinkt | www.wago.com/216-132 |
|  | Art-Nr.: 216-151 Aderendhülse; Hülse für 0,25 mm ² / AWG 24; ohne Kunststoffkragen; galvanisch verzinkt | www.wago.com/216-151 |
|  | Art-Nr.: 216-152 Aderendhülse; Hülse für 0,34 mm ² / AWG 24; ohne Kunststoffkragen; galvanisch verzinkt | www.wago.com/216-152 |
|  | Art-Nr.: 216-201 Aderendhülse; Hülse für 0,5 mm ² / AWG 22; mit Kunststoffkragen; galvanisch verzinkt | www.wago.com/216-201 |
|  | Art-Nr.: 216-202 Aderendhülse; Hülse für 0,75 mm ² / AWG 20; mit Kunststoffkragen; galvanisch verzinkt | www.wago.com/216-202 |
|  | Art-Nr.: 216-203 Aderendhülse; Hülse für 1 mm ² / AWG 18; mit Kunststoffkragen; galvanisch verzinkt | www.wago.com/216-203 |
|  | Art-Nr.: 216-204 Aderendhülse; Hülse für 1,5 mm ² / AWG 16; mit Kunststoffkragen; galvanisch verzinkt | www.wago.com/216-204 |
|  | Art-Nr.: 216-205 Aderendhülse; Hülse für 2,08 mm ² / AWG 14; mit Kunststoffkragen; galvanisch verzinkt | www.wago.com/216-205 |
|  | Art-Nr.: 216-206 Aderendhülse; Hülse für 2,5 mm ² / AWG 14; mit Kunststoffkragen; galvanisch verzinkt | www.wago.com/216-206 |
|  | Art-Nr.: 216-221 Aderendhülse; Hülse für 0,5 mm ² / AWG 22; mit Kunststoffkragen; galvanisch verzinkt | www.wago.com/216-221 |
|  | Art-Nr.: 216-222 Aderendhülse; Hülse für 0,75 mm ² / AWG 20; mit Kunststoffkragen; galvanisch verzinkt | www.wago.com/216-222 |
|  | Art-Nr.: 216-223 Aderendhülse; Hülse für 1 mm ² / AWG 18; mit Kunststoffkragen; galvanisch verzinkt | www.wago.com/216-223 |
|  | Art-Nr.: 216-224 Aderendhülse; Hülse für 1,5 mm ² / AWG 16; mit Kunststoffkragen; galvanisch verzinkt | www.wago.com/216-224 |
|  | Art-Nr.: 216-301 Aderendhülse; Hülse für 0,25 mm ² / AWG 24; mit Kunststoffkragen; galvanisch verzinkt | www.wago.com/216-301 |
|  | Art-Nr.: 216-302 Aderendhülse; Hülse für 0,34 mm ² / AWG 24; mit Kunststoffkragen; galvanisch verzinkt | www.wago.com/216-302 |
|  | Art-Nr.: 216-321 Aderendhülse; Hülse für 0,25 mm ² / AWG 24; mit Kunststoffkragen; galvanisch verzinkt | www.wago.com/216-321 |
|  | Art-Nr.: 216-322 Aderendhülse; Hülse für 0,34 mm ² / AWG 24; mit Kunststoffkragen; galvanisch verzinkt | www.wago.com/216-322 |

Allgemeines Zubehör

| | | |
|--|---|--|
|  | Art-Nr.: 209-123 Montagefuß mit Schraube; an Klemmen mit Befestigungsflansch anschraubbar; 6,4 mm breit | www.wago.com/209-123 |
|--|---|--|

Werkzeug

| | | |
|--|---|--|
|  | Art-Nr.: 209-132 Betätigungswerkzeug; zum Anschließen der Einlegebrücke; 2-fach; aus Isolierstoff | www.wago.com/209-132 |
|--|---|--|

| | | |
|--|---|--|
|  | Art-Nr.: 210-657 Betätigungswerkzeug mit teilisoliertem Schaft; Klinge (3,5 x 0,5) mm; kurz | www.wago.com/210-657 |
|--|---|--|

| | | |
|--|--|--|
|  | Art-Nr.: 210-658 Betätigungswerkzeug mit teilisoliertem Schaft; Klinge (3,5 x 0,5) mm; kurz; abgewinkelt | www.wago.com/210-658 |
|--|--|--|

| | | |
|--|--|--|
|  | Art-Nr.: 210-720 Betätigungswerkzeug mit teilisoliertem Schaft; Typ 2, Klinge (3,5 x 0,5) mm | www.wago.com/210-720 |
|--|--|--|

Montage

| | | |
|--|--|--|
|  | Art-Nr.: 209-137 Montageadapter; als Endklammer verwendbar; 6,5 mm breit | www.wago.com/209-137 |
|--|--|--|

Prüfen und Messen

| | | |
|--|---|--|
|  | Art-Nr.: 210-136 Prüfstecker; Ø 2 mm; mit 500mm-Leitung | www.wago.com/210-136 |
|--|---|--|

| | | |
|--|---|--|
|  | Art-Nr.: 210-137 Prüfstecker; Ø 2,3 mm; mit 500mm-Leitung | www.wago.com/210-137 |
|--|---|--|

| | | |
|--|--|--|
|  | Art-Nr.: 249-139 Prüfsteckermodul; ohne Rastklinken; anreihbar; für 4-Leiter-Klemmen | www.wago.com/249-139 |
|--|--|--|

| | | |
|--|--|--|
|  | Art-Nr.: 261-405 Prüfsteckermodul; mit Rastklinken; anreihbar; für 4-Leiter-Klemmen; für Serie 261 | www.wago.com/261-405 |
|--|--|--|

Brücker

| | | |
|--|---|--|
|  | Art-Nr.: 261-402 Einlegebrücke; isoliert; 2-fach; reduziert anschließbaren Querschnitt auf 1,5 mm | www.wago.com/261-402 |
|--|---|--|

Downloads

Dokumentation

Ausschreibungstext

| | | | |
|---------|--------------|----------------|----------|
| 261-212 | Oct 11, 2017 | DOC 25,6 kB | Download |
|---------|--------------|----------------|----------|



smartDATA

CAD Daten

3D Download 261-212

URL

Download

Änderungen vorbehalten.

WAGO Kontakttechnik GmbH & Co. KG
Hansastr. 27
32423 Minden
Telefon: +49571 887-0
E-Mail: info.de@wago.com | Web: www.wago.com

Haben Sie Fragen zu unseren Produkten?
Wir stehen Ihnen telefonisch unter +49 (571) 887-44222 gern zur
Verfügung.