

Datenblatt | Artikelnummer: 261-427

2-Leiter-Klemmenleiste; mit Befestigungsflansch; für Schraub- u.ä.
Befestigungsarten; Befestigungsloch Ø 3,2 mm; mit Montagefuß 209-123
auch auf TS 35; ohne Betätigungsdrücker

www.wago.com/261-427

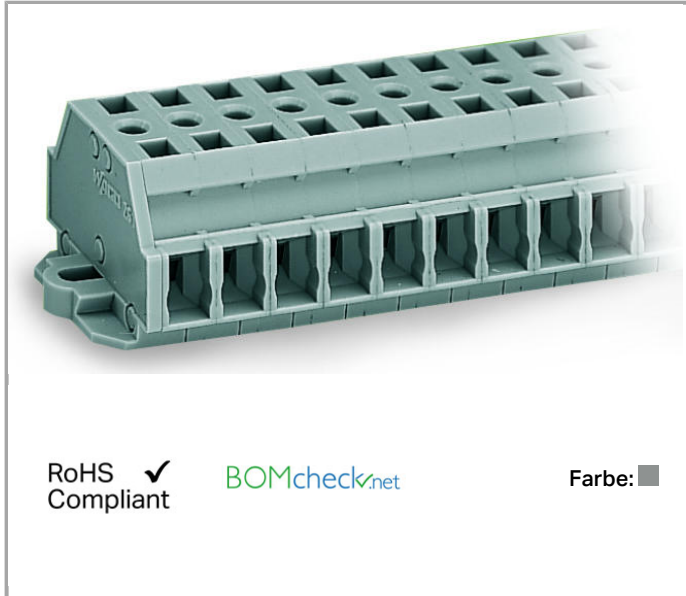

RoHS
Compliant

BOMcheck.net

Farbe: ■

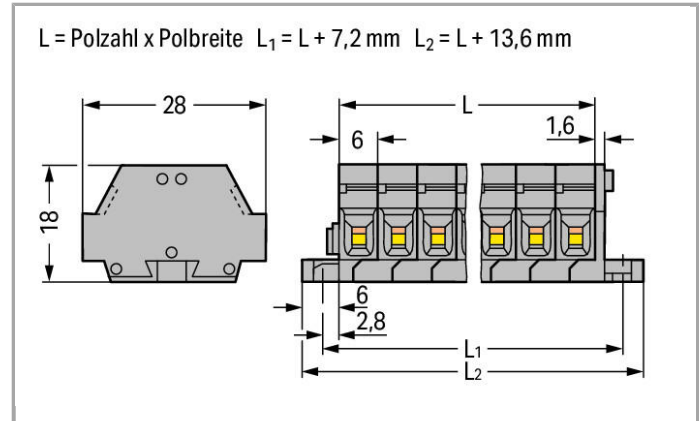

Daten

Elektrische Daten

Bemessungsdaten gemäß IEC/EN 60664-1

Bemessungsspannung (III / 3)	500 V
Bemessungsstoßspannung (III / 3)	6 kV
Bemessungsstrom	24 A
Legende Bemessungsdaten	(III / 3) \triangleq Überspannungskategorie III / Verschmutzungsgrad 3

Anschlussdaten

Anschluss technik	CAGE CLAMP®
Betätigungsart	Betätigungswerkzeug
Anschließbare Leiterwerkstoffe	Kupfer Aluminium
Eindrähtiger Leiter	0,08 ... 2,5 mm ² / 28 ... 14 AWG
Feindrähtiger Leiter	0,08 ... 2,5 mm ² / 28 ... 14 AWG
Abisolierlänge	8 ... 9 mm / 0.31 ... 0.35 inch
Polzahl	7
Gesamte Anzahl der Klemmstellen	14
Gesamte Anzahl der Potentiale	7
Anzahl der Ebenen	1

Verdrahtungsart	Seitliche Verdrahtung
-----------------	-----------------------

Geometrische Daten

Breite	55,6 mm / 2.189 inch
Höhe ab Oberfläche	18 mm / 0.709 inch
Tiefe	28 mm / 1.102 inch

Mechanische Daten

Bauform	horizontale Bauform
Befestigungsart	Befestigungsflansch
Beschriftungsebene	Seitliche Beschriftung

Werkstoffdaten





Farbe	grau
Brandlast	0.338 MJ
Gewicht	18.491 g













Kaufmännische Daten

Ursprungsland	DE
GTIN	4044918627689
Zolltarifnummer	85369010000
eCl@ss 9.0	27-14-11-06
eCl@ss 8.0	27-14-11-06
ETIM 6.0	EC001284
ETIM 5.0	EC001284

Passende Produkte

Beschriftungsmaterial

	Art-Nr.: 2009-145 Mini-WSB Inline; für smartPRINTER; auf Rolle; dehnbar 5 - 5,2 mm; unbedruckt; aufrastbar	www.wago.com/2009-145
	Art-Nr.: 2009-145/000-002 Mini-WSB Inline; für smartPRINTER; auf Rolle; dehnbar 5 - 5,2 mm; unbedruckt; aufrastbar	www.wago.com/2009-145/000-002
	Art-Nr.: 2009-145/000-005 Mini-WSB Inline; für smartPRINTER; auf Rolle; dehnbar 5 - 5,2 mm; unbedruckt; aufrastbar	www.wago.com/2009-145/000-005
	Art-Nr.: 2009-145/000-006 Mini-WSB Inline; für smartPRINTER; auf Rolle; dehnbar 5 - 5,2 mm; unbedruckt; aufrastbar	www.wago.com/2009-145/000-006

	Art-Nr.: 2009-145/000-007 Mini-WSB Inline; für smartPRINTER; auf Rolle; dehnbar 5 - 5,2 mm; unbedruckt; aufrastbar	www.wago.com/2009-145/000-007
	Art-Nr.: 2009-145/000-012 Mini-WSB Inline; für smartPRINTER; auf Rolle; dehnbar 5 - 5,2 mm; unbedruckt; aufrastbar	www.wago.com/2009-145/000-012
	Art-Nr.: 2009-145/000-023 Mini-WSB Inline; für smartPRINTER; auf Rolle; dehnbar 5 - 5,2 mm; unbedruckt; aufrastbar	www.wago.com/2009-145/000-023
	Art-Nr.: 2009-145/000-024 Mini-WSB Inline; auf Rolle; dehnbar 5 - 5,2 mm; unbedruckt; aufrastbar	www.wago.com/2009-145/000-024
	Art-Nr.: 248-501 Mini-WSB-Schnellbeschriftungssystem; unbedruckt; Schildchenbreite 5 mm; 10 Streifen à 10 Schilder pro Karte	www.wago.com/248-501
	Art-Nr.: 248-501/000-002 Mini-WSB-Beschriftungskarte; als Karte; nicht dehnbar; unbedruckt; aufrastbar	www.wago.com/248-501/000-002
	Art-Nr.: 248-501/000-005 Mini-WSB-Beschriftungskarte; als Karte; unbedruckt; aufrastbar	www.wago.com/248-501/000-005
	Art-Nr.: 248-501/000-006 Mini-WSB-Beschriftungskarte; als Karte; nicht dehnbar; unbedruckt; aufrastbar	www.wago.com/248-501/000-006
	Art-Nr.: 248-501/000-007 Mini-WSB-Beschriftungskarte; als Karte; nicht dehnbar; unbedruckt; aufrastbar	www.wago.com/248-501/000-007
	Art-Nr.: 248-501/000-012 Mini-WSB-Beschriftungskarte; als Karte; nicht dehnbar; unbedruckt; aufrastbar	www.wago.com/248-501/000-012
	Art-Nr.: 248-501/000-017 Mini-WSB-Beschriftungskarte; als Karte; nicht dehnbar; unbedruckt; aufrastbar	www.wago.com/248-501/000-017
	Art-Nr.: 248-501/000-023 Mini-WSB-Beschriftungskarte; als Karte; nicht dehnbar; unbedruckt; aufrastbar	www.wago.com/248-501/000-023
	Art-Nr.: 248-501/000-024 Mini-WSB-Beschriftungskarte; als Karte; nicht dehnbar; unbedruckt; aufrastbar	www.wago.com/248-501/000-024

Werkzeug

	Art-Nr.: 209-132 Betätigungswerkzeug; zum Anschließen der Einlegebrücke; 2-fach; aus Isolierstoff	www.wago.com/209-132
--	---	--

	Art-Nr.: 210-657 Betätigungswerkzeug mit teilisoliertem Schaft; Klinge (3,5 x 0,5) mm; kurz	www.wago.com/210-657
--	---	--

	Art-Nr.: 210-658 Betätigungswerkzeug mit teilisoliertem Schaft; Klinge (3,5 x 0,5) mm; kurz; abgewinkelt	www.wago.com/210-658
--	--	--

	Art-Nr.: 210-720 Betätigungswerkzeug mit teilisoliertem Schaft; Typ 2, Klinge (3,5 x 0,5) mm	www.wago.com/210-720
--	--	--

Brücker

	Art-Nr.: 261-402 Einlegebrücke; isoliert; 2-fach; reduziert anschließbaren Querschnitt auf 1,5 mm	www.wago.com/261-402
--	---	--

Montage

	Art-Nr.: 209-137 Montageadapter; als Endklammer verwendbar; 6,5 mm breit	www.wago.com/209-137
--	--	--

Aderendhülse

	Art-Nr.: 216-101 Aderendhülse; Hülse für 0,5 mm ² / AWG 22; ohne Kunststoffkragen; galvanisch verzinkt	www.wago.com/216-101
--	---	--

	Art-Nr.: 216-102 Aderendhülse; Hülse für 0,75 mm ² / AWG 20; ohne Kunststoffkragen; galvanisch verzinkt	www.wago.com/216-102
--	--	--

	Art-Nr.: 216-103 Aderendhülse; Hülse für 1 mm ² / AWG 18; ohne Kunststoffkragen; galvanisch verzinkt	www.wago.com/216-103
--	---	--

	Art-Nr.: 216-104 Aderendhülse; Hülse für 1,5 mm ² / AWG 16; ohne Kunststoffkragen; galvanisch verzinkt	www.wago.com/216-104
--	---	--

	Art-Nr.: 216-106 Aderendhülse; Hülse für 2,5 mm ² / AWG 14; ohne Kunststoffkragen; galvanisch verzinkt	www.wago.com/216-106
--	---	--

	Art-Nr.: 216-121 Aderendhülse; Hülse für 0,5 mm ² / AWG 22; ohne Kunststoffkragen; galvanisch verzinkt	www.wago.com/216-121
--	---	--

	Art-Nr.: 216-122 Aderendhülse; Hülse für 0,75 mm ² / AWG 20; ohne Kunststoffkragen; galvanisch verzinkt	www.wago.com/216-122
--	--	--

	Art-Nr.: 216-123 Aderendhülse; Hülse für 1 mm ² / AWG 18; ohne Kunststoffkragen; galvanisch verzinkt	www.wago.com/216-123
--	---	--

	Art-Nr.: 216-124 Aderendhülse; Hülse für 1,5 mm ² / AWG 16; ohne Kunststoffkragen; galvanisch verzinkt	www.wago.com/216-124
--	---	--

	Art-Nr.: 216-131 Aderendhülse; Hülse für 0,25 mm ² / AWG 24; ohne Kunststoffkragen; galvanisch verzinkt	www.wago.com/216-131
--	--	--

	Art-Nr.: 216-132 Aderendhülse; Hülse für 0,34 mm ² / AWG 24; ohne Kunststoffkragen; galvanisch verzinkt	www.wago.com/216-132
--	--	--

	Art-Nr.: 216-151 Aderendhülse; Hülse für 0,25 mm ² / AWG 24; ohne Kunststoffkragen; galvanisch verzinkt	www.wago.com/216-151
--	--	--

	Art-Nr.: 216-152 Aderendhülse; Hülse für 0,34 mm ² / AWG 24; ohne Kunststoffkragen; galvanisch verzinkt	www.wago.com/216-152
--	--	--



Art-Nr.: 216-201
Aderendhülse; Hülse für 0,5 mm² / AWG 22; mit Kunststoffkragen; galvanisch verzinkt www.wago.com/216-201



Art-Nr.: 216-202
Aderendhülse; Hülse für 0,75 mm² / AWG 20; mit Kunststoffkragen; galvanisch verzinkt www.wago.com/216-202



Art-Nr.: 216-203
Aderendhülse; Hülse für 1 mm² / AWG 18; mit Kunststoffkragen; galvanisch verzinkt www.wago.com/216-203



Art-Nr.: 216-204
Aderendhülse; Hülse für 1,5 mm² / AWG 16; mit Kunststoffkragen; galvanisch verzinkt www.wago.com/216-204



Art-Nr.: 216-205
Aderendhülse; Hülse für 2,08 mm² / AWG 14; mit Kunststoffkragen; galvanisch verzinkt www.wago.com/216-205



Art-Nr.: 216-206
Aderendhülse; Hülse für 2,5 mm² / AWG 14; mit Kunststoffkragen; galvanisch verzinkt www.wago.com/216-206



Art-Nr.: 216-221
Aderendhülse; Hülse für 0,5 mm² / AWG 22; mit Kunststoffkragen; galvanisch verzinkt www.wago.com/216-221



Art-Nr.: 216-222
Aderendhülse; Hülse für 0,75 mm² / AWG 20; mit Kunststoffkragen; galvanisch verzinkt www.wago.com/216-222



Art-Nr.: 216-223
Aderendhülse; Hülse für 1 mm² / AWG 18; mit Kunststoffkragen; galvanisch verzinkt www.wago.com/216-223



Art-Nr.: 216-224
Aderendhülse; Hülse für 1,5 mm² / AWG 16; mit Kunststoffkragen; galvanisch verzinkt www.wago.com/216-224



Art-Nr.: 216-301
Aderendhülse; Hülse für 0,25 mm² / AWG 24; mit Kunststoffkragen; galvanisch verzinkt www.wago.com/216-301



Art-Nr.: 216-302
Aderendhülse; Hülse für 0,34 mm² / AWG 24; mit Kunststoffkragen; galvanisch verzinkt www.wago.com/216-302



Art-Nr.: 216-321
Aderendhülse; Hülse für 0,25 mm² / AWG 24; mit Kunststoffkragen; galvanisch verzinkt www.wago.com/216-321



Art-Nr.: 216-322
Aderendhülse; Hülse für 0,34 mm² / AWG 24; mit Kunststoffkragen; galvanisch verzinkt www.wago.com/216-322

Allgemeines Zubehör



Art-Nr.: 209-123
Montagefuß mit Schraube; an Klemmen mit Befestigungsflansch anschraubbar; 6,4 mm breit www.wago.com/209-123

Prüfen und Messen



Art-Nr.: 210-136
Prüfstecker; Ø 2 mm; mit 500mm-Leitung www.wago.com/210-136



Downloads

Dokumentation

Ausschreibungstext

261-427	Oct 11, 2017	DOC 25,1 kB	Download
---------	--------------	----------------	----------

smartDATA

CAD Daten

3D Download 261-427	URL	Download
---------------------	-----	----------

Änderungen vorbehalten.

WAGO Kontakttechnik GmbH & Co. KG
Hansastr. 27
32423 Minden
Telefon: +49571 887-0
E-Mail: info.de@wago.com | Web: www.wago.com

Haben Sie Fragen zu unseren Produkten?
Wir stehen Ihnen telefonisch unter +49 (571) 887-44222 gern zur
Verfügung.