

## Datenblatt | Artikelnummer: 261-428/331-000

2-Leiter-Klemmenleiste; mit Befestigungsflansch; für Schraub- u.ä.  
Befestigungsarten; Befestigungsloch Ø 3,2 mm; mit Montagefuß 209-123  
auch auf TS 35; mit Betätigungsdrücker

[www.wago.com/261-428/331-000](http://www.wago.com/261-428/331-000)

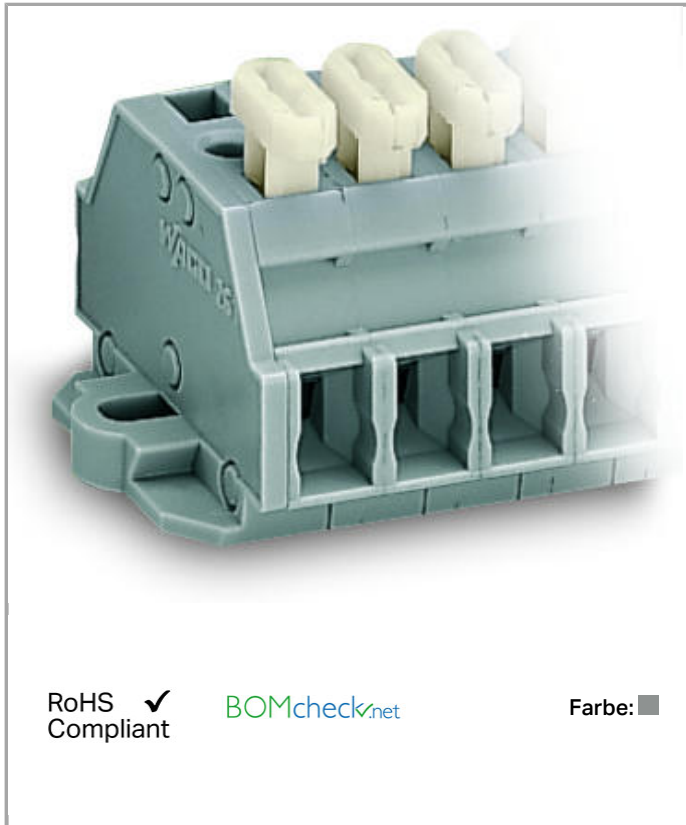

RoHS  Compliant

BOMcheck.net

Farbe: ■

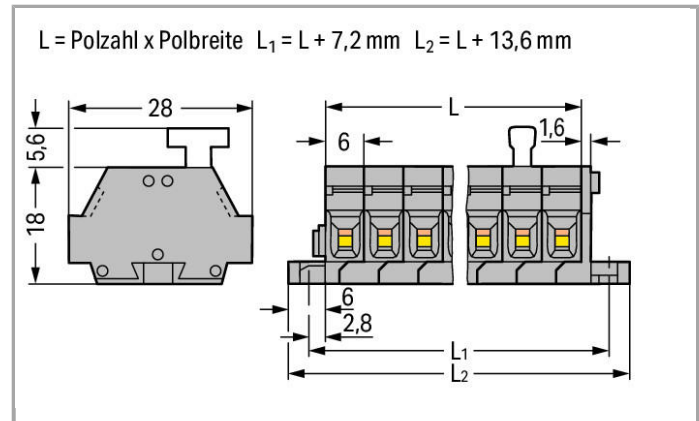

### Daten

#### Elektrische Daten

#### Bemessungsdaten gemäß IEC/EN 60664-1

Bemessungsspannung (III / 3)	500 V
Bemessungsstoßspannung (III / 3)	6 kV
Bemessungsstrom	24 A
Legende Bemessungsdaten	(III / 3) ≙ Überspannungskategorie III / Verschmutzungsgrad 3

#### Anschlussdaten

Anschlusstechnik	CAGE CLAMP®
Betätigungsart	Betätigungswerkzeug Drücker
Anschließbare Leiterwerkstoffe	Kupfer Aluminium
Eindrähtiger Leiter	0,08 ... 2,5 mm <sup>2</sup> / 28 ... 14 AWG

Feindrähtiger Leiter	0,08 ... 2,5 mm <sup>2</sup> / 28 ... 14 AWG
Abisolierlänge	8 ... 9 mm / 0.31 ... 0.35 inch
Polzahl	8
Gesamte Anzahl der Klemmstellen	16
Gesamte Anzahl der Potentiale	8
Anzahl der Ebenen	1
Verdrahtungsart	Seitliche Verdrahtung

### Geometrische Daten

Breite	61,6 mm / 2.425 inch
Höhe ab Oberfläche	23,2 mm / 0.913 inch
Tiefe	28 mm / 1.102 inch

### Mechanische Daten

Bauform	horizontale Bauform
Befestigungsart	Befestigungsflansch
Beschriftungsebene	Seitliche Beschriftung

### Werkstoffdaten

Farbe	grau
Brandlast	0.422 MJ
Gewicht	21.551 g

### Kaufmännische Daten

Ursprungsland	DE
GTIN	4044918626897
Zolltarifnummer	85369010000
eCl@ss 9.0	27-14-11-06
eCl@ss 8.0	27-14-11-06
ETIM 6.0	EC001284
ETIM 5.0	EC001284

### Passende Produkte

#### Allgemeines Zubehör



Art-Nr.: 209-123

Montagefuß mit Schraube; an Klemmen mit Befestigungsflansch anschraubbar; 6,4 mm breit

[www.wago.com/209-123](http://www.wago.com/209-123)

#### Werkzeug



Art-Nr.: 209-132

Betätigungswerkzeug; zum Anschließen der Einlegebrücke; 2-fach; aus Isolierstoff

[www.wago.com/209-132](http://www.wago.com/209-132)

	<b>Art-Nr.: 210-657</b> Betätigungswerkzeug mit teilisoliertem Schaft; Klinge (3,5 x 0,5) mm; kurz	<a href="http://www.wago.com/210-657">www.wago.com/210-657</a>
--	---	--

	<b>Art-Nr.: 210-658</b> Betätigungswerkzeug mit teilisoliertem Schaft; Klinge (3,5 x 0,5) mm; kurz; abgewinkelt	<a href="http://www.wago.com/210-658">www.wago.com/210-658</a>
--	--	--

	<b>Art-Nr.: 210-720</b> Betätigungswerkzeug mit teilisoliertem Schaft; Typ 2, Klinge (3,5 x 0,5) mm	<a href="http://www.wago.com/210-720">www.wago.com/210-720</a>
--	--	--

**Brücker**

	<b>Art-Nr.: 261-402</b> Einlegebrücke; isoliert; 2-fach; reduziert anschließbaren Querschnitt auf 1,5 mm	<a href="http://www.wago.com/261-402">www.wago.com/261-402</a>
--	---	--

**Aderendhülse**

	<b>Art-Nr.: 216-101</b> Aderendhülse; Hülse für 0,5 mm <sup>2</sup> / AWG 22; ohne Kunststoffkragen; galvanisch verzinkt	<a href="http://www.wago.com/216-101">www.wago.com/216-101</a>
--	---	--

	<b>Art-Nr.: 216-102</b> Aderendhülse; Hülse für 0,75 mm <sup>2</sup> / AWG 20; ohne Kunststoffkragen; galvanisch verzinkt	<a href="http://www.wago.com/216-102">www.wago.com/216-102</a>
--	--	--

	<b>Art-Nr.: 216-103</b> Aderendhülse; Hülse für 1 mm <sup>2</sup> / AWG 18; ohne Kunststoffkragen; galvanisch verzinkt	<a href="http://www.wago.com/216-103">www.wago.com/216-103</a>
--	---	--

	<b>Art-Nr.: 216-104</b> Aderendhülse; Hülse für 1,5 mm <sup>2</sup> / AWG 16; ohne Kunststoffkragen; galvanisch verzinkt	<a href="http://www.wago.com/216-104">www.wago.com/216-104</a>
---	---	--

	<b>Art-Nr.: 216-106</b> Aderendhülse; Hülse für 2,5 mm <sup>2</sup> / AWG 14; ohne Kunststoffkragen; galvanisch verzinkt	<a href="http://www.wago.com/216-106">www.wago.com/216-106</a>
--	---	--

	<b>Art-Nr.: 216-121</b> Aderendhülse; Hülse für 0,5 mm <sup>2</sup> / AWG 22; ohne Kunststoffkragen; galvanisch verzinkt	<a href="http://www.wago.com/216-121">www.wago.com/216-121</a>
--	---	--

	<b>Art-Nr.: 216-122</b> Aderendhülse; Hülse für 0,75 mm <sup>2</sup> / AWG 20; ohne Kunststoffkragen; galvanisch verzinkt	<a href="http://www.wago.com/216-122">www.wago.com/216-122</a>
--	--	--

	<b>Art-Nr.: 216-123</b> Aderendhülse; Hülse für 1 mm <sup>2</sup> / AWG 18; ohne Kunststoffkragen; galvanisch verzinkt	<a href="http://www.wago.com/216-123">www.wago.com/216-123</a>
--	---	--

	<b>Art-Nr.: 216-124</b> Aderendhülse; Hülse für 1,5 mm <sup>2</sup> / AWG 16; ohne Kunststoffkragen; galvanisch verzinkt	<a href="http://www.wago.com/216-124">www.wago.com/216-124</a>
--	---	--

	<b>Art-Nr.: 216-131</b> Aderendhülse; Hülse für 0,25 mm <sup>2</sup> / AWG 24; ohne Kunststoffkragen; galvanisch verzinkt	<a href="http://www.wago.com/216-131">www.wago.com/216-131</a>
--	--	--













	<b>Art-Nr.: 216-132</b> Aderendhülse; Hülse für 0,34 mm <sup>2</sup> / AWG 24; ohne Kunststoffkragen; galvanisch verzinkt	<a href="http://www.wago.com/216-132">www.wago.com/216-132</a>
--	--	--

	<b>Art-Nr.: 216-151</b> Aderendhülse; Hülse für 0,25 mm <sup>2</sup> / AWG 24; ohne Kunststoffkragen; galvanisch verzinkt	<a href="http://www.wago.com/216-151">www.wago.com/216-151</a>
--	--	--

	<b>Art-Nr.: 216-152</b> Aderendhülse; Hülse für 0,34 mm <sup>2</sup> / AWG 24; ohne Kunststoffkragen; galvanisch verzinkt	<a href="http://www.wago.com/216-152">www.wago.com/216-152</a>
--	--	--

	<b>Art-Nr.: 216-201</b> Aderendhülse; Hülse für 0,5 mm <sup>2</sup> / AWG 22; mit Kunststoffkragen; galvanisch verzinkt	<a href="http://www.wago.com/216-201">www.wago.com/216-201</a>
--	--	--

**Art-Nr.: 216-202**

	Aderendhülse; Hülse für 0,75 mm <sup>2</sup> / AWG 20; mit Kunststoffkragen; galvanisch verzinkt	<a href="http://www.wago.com/216-202">www.wago.com/216-202</a>
	<b>Art-Nr.: 216-203</b> Aderendhülse; Hülse für 1 mm <sup>2</sup> / AWG 18; mit Kunststoffkragen; galvanisch verzinkt	<a href="http://www.wago.com/216-203">www.wago.com/216-203</a>
	<b>Art-Nr.: 216-204</b> Aderendhülse; Hülse für 1,5 mm <sup>2</sup> / AWG 16; mit Kunststoffkragen; galvanisch verzinkt	<a href="http://www.wago.com/216-204">www.wago.com/216-204</a>
	<b>Art-Nr.: 216-205</b> Aderendhülse; Hülse für 2,08 mm <sup>2</sup> / AWG 14; mit Kunststoffkragen; galvanisch verzinkt	<a href="http://www.wago.com/216-205">www.wago.com/216-205</a>
	<b>Art-Nr.: 216-206</b> Aderendhülse; Hülse für 2,5 mm <sup>2</sup> / AWG 14; mit Kunststoffkragen; galvanisch verzinkt	<a href="http://www.wago.com/216-206">www.wago.com/216-206</a>
	<b>Art-Nr.: 216-221</b> Aderendhülse; Hülse für 0,5 mm <sup>2</sup> / AWG 22; mit Kunststoffkragen; galvanisch verzinkt	<a href="http://www.wago.com/216-221">www.wago.com/216-221</a>
	<b>Art-Nr.: 216-222</b> Aderendhülse; Hülse für 0,75 mm <sup>2</sup> / AWG 20; mit Kunststoffkragen; galvanisch verzinkt	<a href="http://www.wago.com/216-222">www.wago.com/216-222</a>
	<b>Art-Nr.: 216-223</b> Aderendhülse; Hülse für 1 mm <sup>2</sup> / AWG 18; mit Kunststoffkragen; galvanisch verzinkt	<a href="http://www.wago.com/216-223">www.wago.com/216-223</a>
	<b>Art-Nr.: 216-224</b> Aderendhülse; Hülse für 1,5 mm <sup>2</sup> / AWG 16; mit Kunststoffkragen; galvanisch verzinkt	<a href="http://www.wago.com/216-224">www.wago.com/216-224</a>
	<b>Art-Nr.: 216-301</b> Aderendhülse; Hülse für 0,25 mm <sup>2</sup> / AWG 24; mit Kunststoffkragen; galvanisch verzinkt	<a href="http://www.wago.com/216-301">www.wago.com/216-301</a>
	<b>Art-Nr.: 216-302</b> Aderendhülse; Hülse für 0,34 mm <sup>2</sup> / AWG 24; mit Kunststoffkragen; galvanisch verzinkt	<a href="http://www.wago.com/216-302">www.wago.com/216-302</a>
	<b>Art-Nr.: 216-321</b> Aderendhülse; Hülse für 0,25 mm <sup>2</sup> / AWG 24; mit Kunststoffkragen; galvanisch verzinkt	<a href="http://www.wago.com/216-321">www.wago.com/216-321</a>
	<b>Art-Nr.: 216-322</b> Aderendhülse; Hülse für 0,34 mm <sup>2</sup> / AWG 24; mit Kunststoffkragen; galvanisch verzinkt	<a href="http://www.wago.com/216-322">www.wago.com/216-322</a>



#### Montage















	<b>Art-Nr.: 209-137</b> Montageadapter; als Endklammer verwendbar; 6,5 mm breit	<a href="http://www.wago.com/209-137">www.wago.com/209-137</a>
--	--	--

#### Prüfen und Messen

	<b>Art-Nr.: 210-136</b> Prüfstecker; Ø 2 mm; mit 500mm-Leitung	<a href="http://www.wago.com/210-136">www.wago.com/210-136</a>
--	---	--

#### Beschriftungsmaterial

	<b>Art-Nr.: 2009-145</b> Mini-WSB Inline; für smartPRINTER; auf Rolle; dehnbar 5 - 5,2 mm; unbedruckt; aufrastbar	<a href="http://www.wago.com/2009-145">www.wago.com/2009-145</a>
	<b>Art-Nr.: 2009-145/000-002</b> Mini-WSB Inline; für smartPRINTER; auf Rolle; dehnbar 5 - 5,2 mm; unbedruckt; aufrastbar	<a href="http://www.wago.com/2009-145/000-002">www.wago.com/2009-145/000-002</a>

	<p><b>Art-Nr.: 2009-145/000-005</b> Mini-WSB Inline; für smartPRINTER; auf Rolle; dehnbar 5 - 5,2 mm; unbedruckt; aufrastbar</p>	<a href="http://www.wago.com/2009-145/000-005">www.wago.com/2009-145/000-005</a>
	<p><b>Art-Nr.: 2009-145/000-006</b> Mini-WSB Inline; für smartPRINTER; auf Rolle; dehnbar 5 - 5,2 mm; unbedruckt; aufrastbar</p>	<a href="http://www.wago.com/2009-145/000-006">www.wago.com/2009-145/000-006</a>
	<p><b>Art-Nr.: 2009-145/000-007</b> Mini-WSB Inline; für smartPRINTER; auf Rolle; dehnbar 5 - 5,2 mm; unbedruckt; aufrastbar</p>	<a href="http://www.wago.com/2009-145/000-007">www.wago.com/2009-145/000-007</a>
	<p><b>Art-Nr.: 2009-145/000-012</b> Mini-WSB Inline; für smartPRINTER; auf Rolle; dehnbar 5 - 5,2 mm; unbedruckt; aufrastbar</p>	<a href="http://www.wago.com/2009-145/000-012">www.wago.com/2009-145/000-012</a>
	<p><b>Art-Nr.: 2009-145/000-023</b> Mini-WSB Inline; für smartPRINTER; auf Rolle; dehnbar 5 - 5,2 mm; unbedruckt; aufrastbar</p>	<a href="http://www.wago.com/2009-145/000-023">www.wago.com/2009-145/000-023</a>
	<p><b>Art-Nr.: 2009-145/000-024</b> Mini-WSB Inline; auf Rolle; dehnbar 5 - 5,2 mm; unbedruckt; aufrastbar</p>	<a href="http://www.wago.com/2009-145/000-024">www.wago.com/2009-145/000-024</a>
	<p><b>Art-Nr.: 248-501</b> Mini-WSB-Schnellbeschriftungssystem; unbedruckt; Schildchenbreite 5 mm; 10 Streifen à 10 Schilder pro Karte</p>	<a href="http://www.wago.com/248-501">www.wago.com/248-501</a>
	<p><b>Art-Nr.: 248-501/000-002</b> Mini-WSB-Beschriftungskarte; als Karte; nicht dehnbar; unbedruckt; aufrastbar</p>	<a href="http://www.wago.com/248-501/000-002">www.wago.com/248-501/000-002</a>
	<p><b>Art-Nr.: 248-501/000-005</b> Mini-WSB-Beschriftungskarte; als Karte; unbedruckt; aufrastbar</p>	<a href="http://www.wago.com/248-501/000-005">www.wago.com/248-501/000-005</a>
	<p><b>Art-Nr.: 248-501/000-006</b> Mini-WSB-Beschriftungskarte; als Karte; nicht dehnbar; unbedruckt; aufrastbar</p>	<a href="http://www.wago.com/248-501/000-006">www.wago.com/248-501/000-006</a>
	<p><b>Art-Nr.: 248-501/000-007</b> Mini-WSB-Beschriftungskarte; als Karte; nicht dehnbar; unbedruckt; aufrastbar</p>	<a href="http://www.wago.com/248-501/000-007">www.wago.com/248-501/000-007</a>
	<p><b>Art-Nr.: 248-501/000-012</b> Mini-WSB-Beschriftungskarte; als Karte; nicht dehnbar; unbedruckt; aufrastbar</p>	<a href="http://www.wago.com/248-501/000-012">www.wago.com/248-501/000-012</a>
	<p><b>Art-Nr.: 248-501/000-017</b> Mini-WSB-Beschriftungskarte; als Karte; nicht dehnbar; unbedruckt; aufrastbar</p>	<a href="http://www.wago.com/248-501/000-017">www.wago.com/248-501/000-017</a>
	<p><b>Art-Nr.: 248-501/000-023</b> Mini-WSB-Beschriftungskarte; als Karte; nicht dehnbar; unbedruckt; aufrastbar</p>	<a href="http://www.wago.com/248-501/000-023">www.wago.com/248-501/000-023</a>
	<p><b>Art-Nr.: 248-501/000-024</b> Mini-WSB-Beschriftungskarte; als Karte; nicht dehnbar; unbedruckt; aufrastbar</p>	<a href="http://www.wago.com/248-501/000-024">www.wago.com/248-501/000-024</a>



Downloads

Dokumentation

Ausschreibungstext

---

261-428/331-000	Oct 11, 2017	DOC 25,1 kB	Download
-----------------	--------------	----------------	----------

---

smartDATA

CAD Daten

---

3D Download 261-428/331-000	URL	Download
-----------------------------	-----	----------

---

Änderungen vorbehalten.

---

WAGO Kontakttechnik GmbH & Co. KG  
Hansastr. 27  
32423 Minden  
Telefon: +49571 887-0  
E-Mail: [info.de@wago.com](mailto:info.de@wago.com) | Web: [www.wago.com](http://www.wago.com)

Haben Sie Fragen zu unseren Produkten?  
Wir stehen Ihnen telefonisch unter +49 (571) 887-44222 gern zur  
Verfügung.