

Datenblatt | Artikelnummer: 262-105

2-Leiter-Klemmenleiste; mit Befestigungsflanschen; für Schraub- u.ä.
Befestigungsarten; Befestigungsloch Ø 3,2 mm; mit Montagefuß 209-123
auch auf TS 35; 5-polig

www.wago.com/262-105

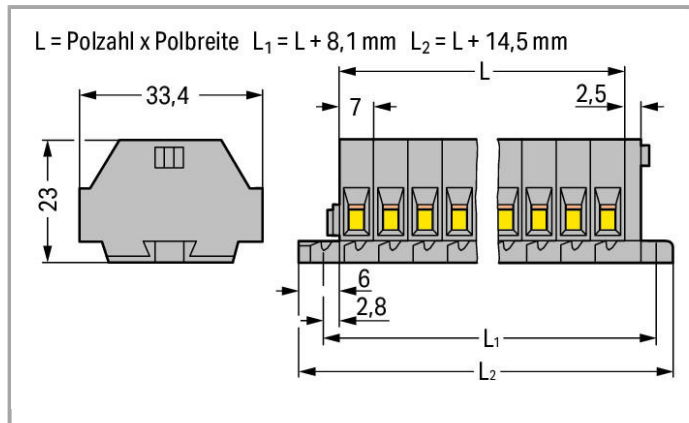
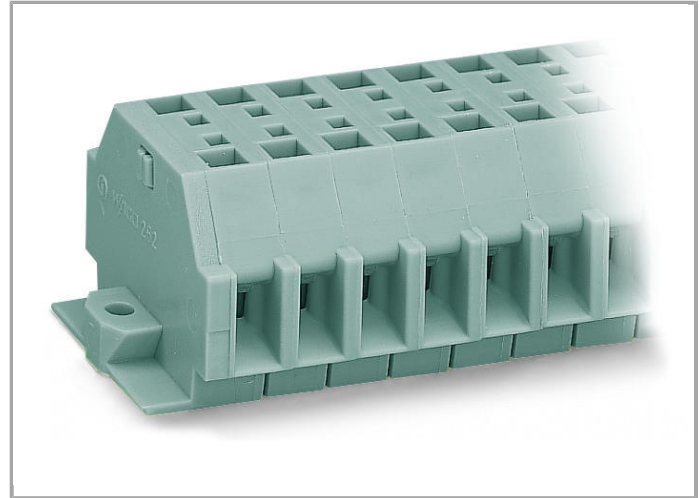
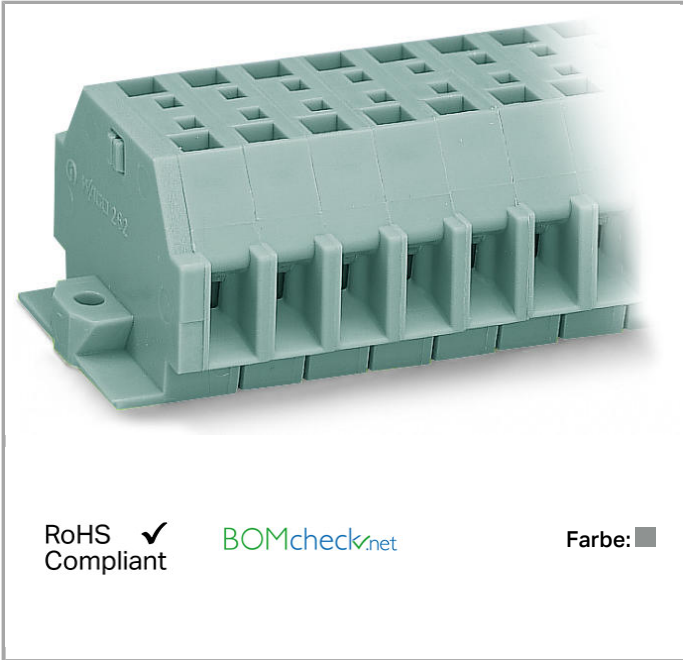

Daten

Elektrische Daten

Bemessungsdaten gemäß IEC/EN 60664-1

| | |
|----------------------------------|---|
| Bemessungsspannung (III / 3) | 630 V |
| Bemessungsstoßspannung (III / 3) | 8 kV |
| Bemessungsstrom | 24 A |
| Legende Bemessungsdaten | (III / 3) ≙ Überspannungskategorie III / Verschmutzungsgrad 3 |

Anschlussdaten

| | |
|---------------------------------|--|
| Anschluss technik | CAGE CLAMP® |
| Betätigungsart | Betätigungswerkzeug |
| Anschließbare Leiterwerkstoffe | Kupfer Aluminium |
| Eindrähtiger Leiter | 0,08 ... 4 mm ² / 28 ... 12 AWG |
| Feindrähtiger Leiter | 0,08 ... 4 mm ² / 28 ... 12 AWG |
| Abisolierlänge | 9 ... 10 mm / 0.35 ... 0.39 inch |
| Polzahl | 5 |
| Gesamte Anzahl der Klemmstellen | 10 |
| Gesamte Anzahl der Potentiale | 5 |
| Anzahl der Ebenen | 1 |
| Verdrahtungsart | Seitliche Verdrahtung |

Geometrische Daten

| | |
|--------------------|----------------------|
| Breite | 49,5 mm / 1.949 inch |
| Höhe ab Oberfläche | 23 mm / 0.906 inch |
| Tiefe | 33,5 mm / 1.319 inch |

Mechanische Daten

| | |
|--------------------|------------------------|
| Bauform | horizontale Bauform |
| Befestigungsart | Befestigungsflansch |
| Beschriftungsebene | Seitliche Beschriftung |

Werkstoffdaten



| | |
|-----------|----------|
| Farbe | grau |
| Brandlast | 0.441 MJ |
| Gewicht | 22.722 g |

Kaufmännische Daten



| | |
|-----------------|------------------|
| Ursprungsland | DE |
| GTIN | 4044918640183 |
| Zolltarifnummer | 85369010000 |
| Produktgruppe | 9 (Mini-Klemmen) |
| eCl@ss 9.0 | 27-14-11-06 |
| eCl@ss 8.0 | 27-14-11-06 |
| ETIM 6.0 | EC001284 |
| ETIM 5.0 | EC001284 |

Zulassungen / Zertifikate

Länderspezifische Zulassungen

| Logo | Zulassung | Zertifikatsname |
|--|--|-----------------|
|  | CCA DEKRA Certification B.V. | NTR-NL 6510 |
|  | CCA DEKRA Certification B.V. | 2110272.03 |
|  | CSA DEKRA Certification B.V. | 70010891 |

Schiff Zulassungen

| Logo | Zulassung | Zertifikatsname |
|--|---|------------------|
|  | ABS American Bureau of Shipping | 14-HG1241539-PDA |
|  | BV Bureau Veritas S.A. | 07436/E0 BV |
|  | LR Lloyds Register | 91/20242 (E7) |

UL-Zulassungen

| Logo | Zulassung | Zertifikatsname |
|--|---|-----------------|
|  | UR Underwriters Laboratories Inc. | E45172 |

Passende Produkte

Montage

| | | |
|--|--|--|
|  | Art-Nr.: 209-137 Montageadapter; als Endklammer verwendbar; 6,5 mm breit | www.wago.com/209-137 |
|--|--|--|

Prüfen und Messen

| | | |
|--|---|--|
|  | Art-Nr.: 210-136 Prüfstecker; Ø 2 mm; mit 500mm-Leitung | www.wago.com/210-136 |
|--|---|--|

| | | |
|--|---|--|
|  | Art-Nr.: 210-137 Prüfstecker; Ø 2,3 mm; mit 500mm-Leitung | www.wago.com/210-137 |
|--|---|--|

| | | |
|--|--|--|
|  | Art-Nr.: 249-137 Prüfsteckermodul; ohne Rastklinken; anreihbar; für 2-Leiter-Klemmen | www.wago.com/249-137 |
|--|--|--|

Allgemeines Zubehör

| | | |
|--|---|--|
|  | Art-Nr.: 209-123 Montagefuß mit Schraube; an Klemmen mit Befestigungsflansch anschraubbar; 6,4 mm breit | www.wago.com/209-123 |
|--|---|--|

Brücker

| | | |
|--|---|--|
|  | Art-Nr.: 262-402 Einlegebrücke; isoliert; 2-fach; reduziert den anschließbaren Querschnitt auf 2,5 mm | www.wago.com/262-402 |
|--|---|--|

Aderendhülse

| | | |
|--|---|--|
|  | Art-Nr.: 216-101 Aderendhülse; Hülse für 0,5 mm ² / AWG 22; ohne Kunststoffkragen; galvanisch verzinkt | www.wago.com/216-101 |
|--|---|--|

| | | |
|--|--|--|
|  | Art-Nr.: 216-102 Aderendhülse; Hülse für 0,75 mm ² / AWG 20; ohne Kunststoffkragen; galvanisch verzinkt | www.wago.com/216-102 |
|--|--|--|

| | | |
|--|---|--|
|  | Art-Nr.: 216-103 Aderendhülse; Hülse für 1 mm ² / AWG 18; ohne Kunststoffkragen; galvanisch verzinkt | www.wago.com/216-103 |
|--|---|--|

| | | |
|--|---|--|
|  | Art-Nr.: 216-104 Aderendhülse; Hülse für 1,5 mm ² / AWG 16; ohne Kunststoffkragen; galvanisch verzinkt | www.wago.com/216-104 |
|--|---|--|

| | | |
|--|---|--|
|  | Art-Nr.: 216-108 Aderendhülse; Hülse für 6 mm ² / AWG 10; ohne Kunststoffkragen; galvanisch verzinkt | www.wago.com/216-108 |
|--|---|--|

| | | |
|--|---|--|
|  | Art-Nr.: 216-109 Aderendhülse; Hülse für 10 mm ² / AWG 8; ohne Kunststoffkragen; galvanisch verzinkt | www.wago.com/216-109 |
|--|---|--|

| | | |
|--|---|--|
|  | Art-Nr.: 216-110 Aderendhülse; Hülse für 16 mm ² / AWG 6; ohne Kunststoffkragen; galvanisch verzinkt | www.wago.com/216-110 |
|--|---|--|

| | | |
|--|---|--|
|  | Art-Nr.: 216-121 Aderendhülse; Hülse für 0,5 mm ² / AWG 22; ohne Kunststoffkragen; galvanisch verzinkt | www.wago.com/216-121 |
|--|---|--|

| | | |
|--|--|--|
|  | Art-Nr.: 216-122 Aderendhülse; Hülse für 0,75 mm ² / AWG 20; ohne Kunststoffkragen; galvanisch verzinkt | www.wago.com/216-122 |
|--|--|--|



















| | | |
|--|---|--|
|  | Art-Nr.: 216-123 Aderendhülse; Hülse für 1 mm ² / AWG 18; ohne Kunststoffkragen; galvanisch verzinkt | www.wago.com/216-123 |
|--|---|--|



















| | | |
|--|---|--|
|  | Art-Nr.: 216-124 Aderendhülse; Hülse für 1,5 mm ² / AWG 16; ohne Kunststoffkragen; galvanisch verzinkt | www.wago.com/216-124 |
|--|---|--|

| | | |
|--|--|--|
|  | Art-Nr.: 216-131 Aderendhülse; Hülse für 0,25 mm ² / AWG 24; ohne Kunststoffkragen; galvanisch verzinkt | www.wago.com/216-131 |
|--|--|--|

| | | |
|--|--|--|
|  | Art-Nr.: 216-132 Aderendhülse; Hülse für 0,34 mm ² / AWG 24; ohne Kunststoffkragen; galvanisch verzinkt | www.wago.com/216-132 |
|--|--|--|

| | |
|--|--|
| Art-Nr.: 216-141 Aderendhülse; Hülse für 0,5 mm ² / AWG 22; ohne Kunststoffkragen; galvanisch verzinkt; | www.wago.com/216-141 |
|--|--|

| | | |
|---|---|--|
|  | Elektrolytkupfer; gasdicht aufgecrimpt; gemäß DIN 46228, Teil 1/08.92 | |
|  | Art-Nr.: 216-142 Aderendhülse; Hülse für 0,75 mm ² / AWG 20; ohne Kunststoffkragen; galvanisch verzinkt; Elektrolytkupfer; gasdicht aufgecrimpt; gemäß DIN 46228, Teil 1/08.92 | www.wago.com/216-142 |
|  | Art-Nr.: 216-143 Aderendhülse; Hülse für 1 mm ² / AWG 18; ohne Kunststoffkragen; galvanisch verzinkt; Elektrolytkupfer; gasdicht aufgecrimpt; gemäß DIN 46228, Teil 1/08.92 | www.wago.com/216-143 |
|  | Art-Nr.: 216-144 Aderendhülse; Hülse für 1,5 mm ² / AWG 16; ohne Kunststoffkragen; galvanisch verzinkt; Elektrolytkupfer; gasdicht aufgecrimpt; gemäß DIN 46228, Teil 1/08.92 | www.wago.com/216-144 |
|  | Art-Nr.: 216-151 Aderendhülse; Hülse für 0,25 mm ² / AWG 24; ohne Kunststoffkragen; galvanisch verzinkt | www.wago.com/216-151 |
|  | Art-Nr.: 216-152 Aderendhülse; Hülse für 0,34 mm ² / AWG 24; ohne Kunststoffkragen; galvanisch verzinkt | www.wago.com/216-152 |
|  | Art-Nr.: 216-201 Aderendhülse; Hülse für 0,5 mm ² / AWG 22; mit Kunststoffkragen; galvanisch verzinkt | www.wago.com/216-201 |
|  | Art-Nr.: 216-202 Aderendhülse; Hülse für 0,75 mm ² / AWG 20; mit Kunststoffkragen; galvanisch verzinkt | www.wago.com/216-202 |
|  | Art-Nr.: 216-203 Aderendhülse; Hülse für 1 mm ² / AWG 18; mit Kunststoffkragen; galvanisch verzinkt | www.wago.com/216-203 |
|  | Art-Nr.: 216-204 Aderendhülse; Hülse für 1,5 mm ² / AWG 16; mit Kunststoffkragen; galvanisch verzinkt | www.wago.com/216-204 |
|  | Art-Nr.: 216-205 Aderendhülse; Hülse für 2,08 mm ² / AWG 14; mit Kunststoffkragen; galvanisch verzinkt | www.wago.com/216-205 |
|  | Art-Nr.: 216-206 Aderendhülse; Hülse für 2,5 mm ² / AWG 14; mit Kunststoffkragen; galvanisch verzinkt | www.wago.com/216-206 |
|  | Art-Nr.: 216-208 Aderendhülse; Hülse für 6 mm ² / AWG 10; mit Kunststoffkragen; galvanisch verzinkt; Elektrolytkupfer; gasdicht aufgecrimpt; gemäß DIN 46228, Teil 4/09.90 | www.wago.com/216-208 |
|  | Art-Nr.: 216-209 Aderendhülse; Hülse für 10 mm ² / AWG 8; mit Kunststoffkragen; galvanisch verzinkt | www.wago.com/216-209 |
|  | Art-Nr.: 216-210 Aderendhülse; Hülse für 16 mm ² / AWG 6; mit Kunststoffkragen; galvanisch verzinkt; Elektrolytkupfer; gasdicht aufgecrimpt; gemäß DIN 46228, Teil 4/09.90 | www.wago.com/216-210 |
|  | Art-Nr.: 216-221 Aderendhülse; Hülse für 0,5 mm ² / AWG 22; mit Kunststoffkragen; galvanisch verzinkt | www.wago.com/216-221 |
|  | Art-Nr.: 216-222 Aderendhülse; Hülse für 0,75 mm ² / AWG 20; mit Kunststoffkragen; galvanisch verzinkt | www.wago.com/216-222 |
|  | Art-Nr.: 216-223 Aderendhülse; Hülse für 1 mm ² / AWG 18; mit Kunststoffkragen; galvanisch verzinkt | www.wago.com/216-223 |
|  | Art-Nr.: 216-224 Aderendhülse; Hülse für 1,5 mm ² / AWG 16; mit Kunststoffkragen; galvanisch verzinkt | www.wago.com/216-224 |
| | Art-Nr.: 216-241 | |

| | |
|---|--|
|  | Aderendhülse; Hülse für 0,5 mm ² / AWG 22; mit Kunststoffkragen; galvanisch verzinkt; Elektrolytkupfer; www.wago.com/216-241 gasdicht aufgecrimpt; gemäß DIN 46228, Teil 4/09.90 |
|  | Art-Nr.: 216-242 Aderendhülse; Hülse für 0,75 mm ² / AWG 20; mit Kunststoffkragen; galvanisch verzinkt; Elektrolytkupfer; www.wago.com/216-242 gasdicht aufgecrimpt; gemäß DIN 46228, Teil 4/09.90 |
|  | Art-Nr.: 216-243 Aderendhülse; Hülse für 1 mm ² / AWG 18; mit Kunststoffkragen; galvanisch verzinkt; Elektrolytkupfer; www.wago.com/216-243 gasdicht aufgecrimpt; gemäß DIN 46228, Teil 4/09.90 |
|  | Art-Nr.: 216-244 Aderendhülse; Hülse für 1,5 mm ² / AWG 16; mit Kunststoffkragen; galvanisch verzinkt; Elektrolytkupfer; www.wago.com/216-244 gasdicht aufgecrimpt; gemäß DIN 46228, Teil 4/09.90 |
|  | Art-Nr.: 216-246 Aderendhülse; Hülse für 2,5 mm ² / AWG 14; mit Kunststoffkragen; galvanisch verzinkt; Elektrolytkupfer; www.wago.com/216-246 gasdicht aufgecrimpt; gemäß DIN 46228, Teil 4/09.90 |
|  | Art-Nr.: 216-262 Aderendhülse; Hülse für 0,75 mm ² / AWG 20; mit Kunststoffkragen; galvanisch verzinkt; Elektrolytkupfer; www.wago.com/216-262 gasdicht aufgecrimpt; gemäß DIN 46228, Teil 4/09.90 |
|  | Art-Nr.: 216-263 Aderendhülse; Hülse für 1 mm ² / AWG 18; mit Kunststoffkragen; galvanisch verzinkt; Elektrolytkupfer; www.wago.com/216-263 gasdicht aufgecrimpt; gemäß DIN 46228, Teil 4/09.90 |
|  | Art-Nr.: 216-264 Aderendhülse; Hülse für 1,5 mm ² / AWG 16; mit Kunststoffkragen; galvanisch verzinkt; Elektrolytkupfer; www.wago.com/216-264 gasdicht aufgecrimpt; gemäß DIN 46228, Teil 4/09.90 |
|  | Art-Nr.: 216-266 Aderendhülse; Hülse für 2,5 mm ² / AWG 14; mit Kunststoffkragen; galvanisch verzinkt; Elektrolytkupfer; www.wago.com/216-266 gasdicht aufgecrimpt; gemäß DIN 46228, Teil 4/09.90 |
|  | Art-Nr.: 216-267 Aderendhülse; Hülse für 4 mm ² / AWG 12; mit Kunststoffkragen; galvanisch verzinkt; Elektrolytkupfer; www.wago.com/216-267 gasdicht aufgecrimpt; gemäß DIN 46228, Teil 4/09.90 |
|  | Art-Nr.: 216-284 Aderendhülse; Hülse für 1,5 mm ² / AWG 16; mit Kunststoffkragen; galvanisch verzinkt; Elektrolytkupfer; www.wago.com/216-284 gasdicht aufgecrimpt; gemäß DIN 46228, Teil 4/09.90 |
|  | Art-Nr.: 216-286 Aderendhülse; Hülse für 2,5 mm ² / AWG 14; mit Kunststoffkragen; galvanisch verzinkt; Elektrolytkupfer; www.wago.com/216-286 gasdicht aufgecrimpt; gemäß DIN 46228, Teil 4/09.90 |
|  | Art-Nr.: 216-287 Aderendhülse; Hülse für 4 mm ² / AWG 12; mit Kunststoffkragen; galvanisch verzinkt; Elektrolytkupfer; www.wago.com/216-287 gasdicht aufgecrimpt; gemäß DIN 46228, Teil 4/09.90 |
|  | Art-Nr.: 216-288 Aderendhülse; Hülse für 6 mm ² / AWG 10; mit Kunststoffkragen; galvanisch verzinkt; Elektrolytkupfer; www.wago.com/216-288 gasdicht aufgecrimpt; gemäß DIN 46228, Teil 4/09.90 |
|  | Art-Nr.: 216-289 Aderendhülse; Hülse für 10 mm ² / AWG 8; mit Kunststoffkragen; galvanisch verzinkt; Elektrolytkupfer; www.wago.com/216-289 gasdicht aufgecrimpt; gemäß DIN 46228, Teil 4/09.90 |
|  | Art-Nr.: 216-301 Aderendhülse; Hülse für 0,25 mm ² / AWG 24; mit Kunststoffkragen; galvanisch verzinkt www.wago.com/216-301 |
|  | Art-Nr.: 216-302 Aderendhülse; Hülse für 0,34 mm ² / AWG 24; mit Kunststoffkragen; galvanisch verzinkt www.wago.com/216-302 |
|  | Art-Nr.: 216-321 Aderendhülse; Hülse für 0,25 mm ² / AWG 24; mit Kunststoffkragen; galvanisch verzinkt www.wago.com/216-321 |



Art-Nr.: 216-322

Aderendhülse; Hülse für 0,34 mm² / AWG 24; mit Kunststoffkragen; galvanisch verzinkt

www.wago.com/216-322

Werkzeug



Art-Nr.: 209-132

Betätigungswerkzeug; zum Anschließen der Einlegebrücke; 2-fach; aus Isolierstoff

www.wago.com/209-132



Art-Nr.: 210-657

Betätigungswerkzeug mit teilisoliertem Schaft; Klinge (3,5 x 0,5) mm; kurz

www.wago.com/210-657



Art-Nr.: 210-658

Betätigungswerkzeug mit teilisoliertem Schaft; Klinge (3,5 x 0,5) mm; kurz; abgewinkelt

www.wago.com/210-658



Art-Nr.: 210-720

Betätigungswerkzeug mit teilisoliertem Schaft; Typ 2, Klinge (3,5 x 0,5) mm

www.wago.com/210-720

Downloads

Dokumentation

Ausschreibungstext

262-105

Oct 11, 2017

DOC
25,1 kB

Download

smartDATA

CAD Daten

3D Download 262-105

URL

Download

Änderungen vorbehalten.

WAGO Kontakttechnik GmbH & Co. KG

Hansastr. 27

32423 Minden

Telefon: +49571 887-0

E-Mail: info.de@wago.com | Web: www.wago.com

Haben Sie Fragen zu unseren Produkten?

Wir stehen Ihnen telefonisch unter +49 (571) 887-44222 gern zur Verfügung.