

Datenblatt | Artikelnummer: 262-108

2-Leiter-Klemmenleiste; mit Befestigungsflanschen; für Schraub- u.ä.
Befestigungsarten; Befestigungsloch Ø 3,2 mm; mit Montagefuß 209-123
auch auf TS 35; 8-polig

www.wago.com/262-108

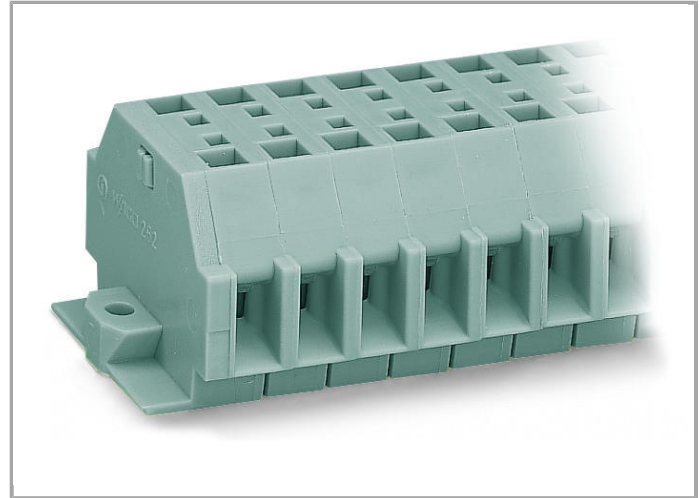
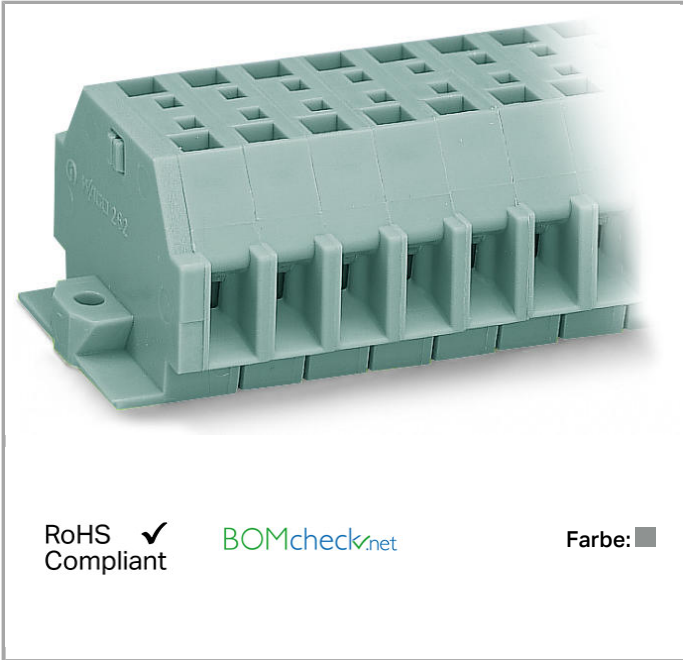

RoHS
Compliant

[BOMcheck.net](https://www.bomcheck.net)

Farbe: ■

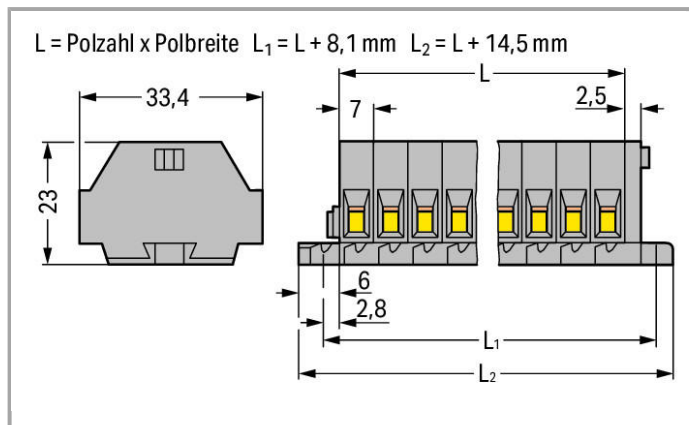

Daten

Elektrische Daten

Bemessungsdaten gemäß IEC/EN 60664-1

Bemessungsspannung (III / 3)	630 V
Bemessungsstoßspannung (III / 3)	8 kV
Bemessungsstrom	24 A
Legende Bemessungsdaten	(III / 3) ≙ Überspannungskategorie III / Verschmutzungsgrad 3

Anschlussdaten

Anschluss technik	CAGE CLAMP®
Betätigungsart	Betätigungswerkzeug
Anschließbare Leiterwerkstoffe	Kupfer Aluminium
Eindrähtiger Leiter	0,08 ... 4 mm ² / 28 ... 12 AWG
Feindrähtiger Leiter	0,08 ... 4 mm ² / 28 ... 12 AWG
Abisolierlänge	9 ... 10 mm / 0.35 ... 0.39 inch
Polzahl	8
Gesamte Anzahl der Klemmstellen	16
Gesamte Anzahl der Potentiale	8
Anzahl der Ebenen	1
Verdrahtungsart	Seitliche Verdrahtung

Geometrische Daten

Breite	70,5 mm / 2.776 inch
Höhe ab Oberfläche	23 mm / 0.906 inch
Tiefe	33,5 mm / 1.319 inch

Mechanische Daten

Bauform	horizontale Bauform
Befestigungsart	Befestigungsflansch
Beschriftungsebene	Seitliche Beschriftung

Werkstoffdaten



Farbe	grau
Brandlast	0.672 MJ
Gewicht	35.232 g

Kaufmännische Daten



Ursprungsland	DE
GTIN	4044918640220
Zolltarifnummer	85369010000
Produktgruppe	9 (Mini-Klemmen)
eCl@ss 9.0	27-14-11-06
eCl@ss 8.0	27-14-11-06
ETIM 6.0	EC001284
ETIM 5.0	EC001284

Zulassungen / Zertifikate

Länderspezifische Zulassungen

Logo	Zulassung	Zertifikatsname
	CCA DEKRA Certification B.V.	NTR-NL 6510
	CCA DEKRA Certification B.V.	2110272.03
	CSA DEKRA Certification B.V.	70010891

Schiff Zulassungen

Logo	Zulassung	Zertifikatsname
	ABS American Bureau of Shipping	14-HG1241539-PDA
	BV Bureau Veritas S.A.	07436/E0 BV
	LR Lloyds Register	91/20242 (E7)

UL-Zulassungen

Logo	Zulassung	Zertifikatsname
	UR Underwriters Laboratories Inc.	E45172

Passende Produkte

Allgemeines Zubehör

	Art-Nr.: 209-123 Montagefuß mit Schraube; an Klemmen mit Befestigungsflansch anschraubbar; 6,4 mm breit	www.wago.com/209-123
--	---	--

Montage

	Art-Nr.: 209-137 Montageadapter; als Endklammer verwendbar; 6,5 mm breit	www.wago.com/209-137
--	--	--

Brücker

	Art-Nr.: 262-402 Einlegebrücke; isoliert; 2-fach; reduziert den anschließbaren Querschnitt auf 2,5 mm	www.wago.com/262-402
--	---	--

Prüfen und Messen

	Art-Nr.: 210-136 Prüfstecker; Ø 2 mm; mit 500mm-Leitung	www.wago.com/210-136
--	---	--

	Art-Nr.: 210-137 Prüfstecker; Ø 2,3 mm; mit 500mm-Leitung	www.wago.com/210-137
--	---	--

	Art-Nr.: 249-137 Prüfsteckermodul; ohne Rastklinken; anreihbar; für 2-Leiter-Klemmen	www.wago.com/249-137
--	--	--

Werkzeug

	Art-Nr.: 209-132 Betätigungswerkzeug; zum Anschließen der Einlegebrücke; 2-fach; aus Isolierstoff	www.wago.com/209-132
--	---	--

	Art-Nr.: 210-657 Betätigungswerkzeug mit teilisoliertem Schaft; Klinge (3,5 x 0,5) mm; kurz	www.wago.com/210-657
--	---	--

	Art-Nr.: 210-658 Betätigungswerkzeug mit teilisoliertem Schaft; Klinge (3,5 x 0,5) mm; kurz; abgewinkelt	www.wago.com/210-658
---	--	--

	Art-Nr.: 210-720 Betätigungswerkzeug mit teilisoliertem Schaft; Typ 2, Klinge (3,5 x 0,5) mm	www.wago.com/210-720
--	--	--

Aderendhülse

	Art-Nr.: 216-101 Aderendhülse; Hülse für 0,5 mm ² / AWG 22; ohne Kunststoffkragen; galvanisch verzinkt	www.wago.com/216-101
--	---	--

	Art-Nr.: 216-102 Aderendhülse; Hülse für 0,75 mm ² / AWG 20; ohne Kunststoffkragen; galvanisch verzinkt	www.wago.com/216-102
--	--	--

	Art-Nr.: 216-103 Aderendhülse; Hülse für 1 mm ² / AWG 18; ohne Kunststoffkragen; galvanisch verzinkt	www.wago.com/216-103
--	---	--

	Art-Nr.: 216-104 Aderendhülse; Hülse für 1,5 mm ² / AWG 16; ohne Kunststoffkragen; galvanisch verzinkt	www.wago.com/216-104
--	---	--



















	Art-Nr.: 216-108 Aderendhülse; Hülse für 6 mm ² / AWG 10; ohne Kunststoffkragen; galvanisch verzinkt	www.wago.com/216-108
--	---	--



	Art-Nr.: 216-109 Aderendhülse; Hülse für 10 mm ² / AWG 8; ohne Kunststoffkragen; galvanisch verzinkt	www.wago.com/216-109
--	---	--

	Art-Nr.: 216-110 Aderendhülse; Hülse für 16 mm ² / AWG 6; ohne Kunststoffkragen; galvanisch verzinkt	www.wago.com/216-110
--	---	--

	Art-Nr.: 216-121 Aderendhülse; Hülse für 0,5 mm ² / AWG 22; ohne Kunststoffkragen; galvanisch verzinkt	www.wago.com/216-121
--	---	--

	Art-Nr.: 216-122 Aderendhülse; Hülse für 0,75 mm ² / AWG 20; ohne Kunststoffkragen; galvanisch verzinkt	www.wago.com/216-122
--	--	--

	Art-Nr.: 216-123 Aderendhülse; Hülse für 1 mm ² / AWG 18; ohne Kunststoffkragen; galvanisch verzinkt	www.wago.com/216-123
	Art-Nr.: 216-124 Aderendhülse; Hülse für 1,5 mm ² / AWG 16; ohne Kunststoffkragen; galvanisch verzinkt	www.wago.com/216-124
	Art-Nr.: 216-131 Aderendhülse; Hülse für 0,25 mm ² / AWG 24; ohne Kunststoffkragen; galvanisch verzinkt	www.wago.com/216-131
	Art-Nr.: 216-132 Aderendhülse; Hülse für 0,34 mm ² / AWG 24; ohne Kunststoffkragen; galvanisch verzinkt	www.wago.com/216-132
	Art-Nr.: 216-141 Aderendhülse; Hülse für 0,5 mm ² / AWG 22; ohne Kunststoffkragen; galvanisch verzinkt; Elektrolytkupfer; gasdicht aufgecrimpt; gemäß DIN 46228, Teil 1/08.92	www.wago.com/216-141
	Art-Nr.: 216-142 Aderendhülse; Hülse für 0,75 mm ² / AWG 20; ohne Kunststoffkragen; galvanisch verzinkt; Elektrolytkupfer; gasdicht aufgecrimpt; gemäß DIN 46228, Teil 1/08.92	www.wago.com/216-142
	Art-Nr.: 216-143 Aderendhülse; Hülse für 1 mm ² / AWG 18; ohne Kunststoffkragen; galvanisch verzinkt; Elektrolytkupfer; gasdicht aufgecrimpt; gemäß DIN 46228, Teil 1/08.92	www.wago.com/216-143
	Art-Nr.: 216-144 Aderendhülse; Hülse für 1,5 mm ² / AWG 16; ohne Kunststoffkragen; galvanisch verzinkt; Elektrolytkupfer; gasdicht aufgecrimpt; gemäß DIN 46228, Teil 1/08.92	www.wago.com/216-144
	Art-Nr.: 216-151 Aderendhülse; Hülse für 0,25 mm ² / AWG 24; ohne Kunststoffkragen; galvanisch verzinkt	www.wago.com/216-151
	Art-Nr.: 216-152 Aderendhülse; Hülse für 0,34 mm ² / AWG 24; ohne Kunststoffkragen; galvanisch verzinkt	www.wago.com/216-152
	Art-Nr.: 216-201 Aderendhülse; Hülse für 0,5 mm ² / AWG 22; mit Kunststoffkragen; galvanisch verzinkt	www.wago.com/216-201
	Art-Nr.: 216-202 Aderendhülse; Hülse für 0,75 mm ² / AWG 20; mit Kunststoffkragen; galvanisch verzinkt	www.wago.com/216-202
	Art-Nr.: 216-203 Aderendhülse; Hülse für 1 mm ² / AWG 18; mit Kunststoffkragen; galvanisch verzinkt	www.wago.com/216-203
	Art-Nr.: 216-204 Aderendhülse; Hülse für 1,5 mm ² / AWG 16; mit Kunststoffkragen; galvanisch verzinkt	www.wago.com/216-204
	Art-Nr.: 216-205 Aderendhülse; Hülse für 2,08 mm ² / AWG 14; mit Kunststoffkragen; galvanisch verzinkt	www.wago.com/216-205
	Art-Nr.: 216-206 Aderendhülse; Hülse für 2,5 mm ² / AWG 14; mit Kunststoffkragen; galvanisch verzinkt	www.wago.com/216-206
	Art-Nr.: 216-208 Aderendhülse; Hülse für 6 mm ² / AWG 10; mit Kunststoffkragen; galvanisch verzinkt; Elektrolytkupfer; gasdicht aufgecrimpt; gemäß DIN 46228, Teil 4/09.90	www.wago.com/216-208
	Art-Nr.: 216-209 Aderendhülse; Hülse für 10 mm ² / AWG 8; mit Kunststoffkragen; galvanisch verzinkt	www.wago.com/216-209
	Art-Nr.: 216-210 Aderendhülse; Hülse für 16 mm ² / AWG 6; mit Kunststoffkragen; galvanisch verzinkt; Elektrolytkupfer; gasdicht aufgecrimpt; gemäß DIN 46228, Teil 4/09.90	www.wago.com/216-210

	Art-Nr.: 216-221 Aderendhülse; Hülse für 0,5 mm ² / AWG 22; mit Kunststoffkragen; galvanisch verzinkt	www.wago.com/216-221
	Art-Nr.: 216-222 Aderendhülse; Hülse für 0,75 mm ² / AWG 20; mit Kunststoffkragen; galvanisch verzinkt	www.wago.com/216-222
	Art-Nr.: 216-223 Aderendhülse; Hülse für 1 mm ² / AWG 18; mit Kunststoffkragen; galvanisch verzinkt	www.wago.com/216-223
	Art-Nr.: 216-224 Aderendhülse; Hülse für 1,5 mm ² / AWG 16; mit Kunststoffkragen; galvanisch verzinkt	www.wago.com/216-224
	Art-Nr.: 216-241 Aderendhülse; Hülse für 0,5 mm ² / AWG 22; mit Kunststoffkragen; galvanisch verzinkt; Elektrolytkupfer; gasdicht aufgecrimpt; gemäß DIN 46228, Teil 4/09.90	www.wago.com/216-241
	Art-Nr.: 216-242 Aderendhülse; Hülse für 0,75 mm ² / AWG 20; mit Kunststoffkragen; galvanisch verzinkt; Elektrolytkupfer; gasdicht aufgecrimpt; gemäß DIN 46228, Teil 4/09.90	www.wago.com/216-242
	Art-Nr.: 216-243 Aderendhülse; Hülse für 1 mm ² / AWG 18; mit Kunststoffkragen; galvanisch verzinkt; Elektrolytkupfer; gasdicht aufgecrimpt; gemäß DIN 46228, Teil 4/09.90	www.wago.com/216-243
	Art-Nr.: 216-244 Aderendhülse; Hülse für 1,5 mm ² / AWG 16; mit Kunststoffkragen; galvanisch verzinkt; Elektrolytkupfer; gasdicht aufgecrimpt; gemäß DIN 46228, Teil 4/09.90	www.wago.com/216-244
	Art-Nr.: 216-246 Aderendhülse; Hülse für 2,5 mm ² / AWG 14; mit Kunststoffkragen; galvanisch verzinkt; Elektrolytkupfer; gasdicht aufgecrimpt; gemäß DIN 46228, Teil 4/09.90	www.wago.com/216-246
	Art-Nr.: 216-262 Aderendhülse; Hülse für 0,75 mm ² / AWG 20; mit Kunststoffkragen; galvanisch verzinkt; Elektrolytkupfer; gasdicht aufgecrimpt; gemäß DIN 46228, Teil 4/09.90	www.wago.com/216-262
	Art-Nr.: 216-263 Aderendhülse; Hülse für 1 mm ² / AWG 18; mit Kunststoffkragen; galvanisch verzinkt; Elektrolytkupfer; gasdicht aufgecrimpt; gemäß DIN 46228, Teil 4/09.90	www.wago.com/216-263
	Art-Nr.: 216-264 Aderendhülse; Hülse für 1,5 mm ² / AWG 16; mit Kunststoffkragen; galvanisch verzinkt; Elektrolytkupfer; gasdicht aufgecrimpt; gemäß DIN 46228, Teil 4/09.90	www.wago.com/216-264
	Art-Nr.: 216-266 Aderendhülse; Hülse für 2,5 mm ² / AWG 14; mit Kunststoffkragen; galvanisch verzinkt; Elektrolytkupfer; gasdicht aufgecrimpt; gemäß DIN 46228, Teil 4/09.90	www.wago.com/216-266
	Art-Nr.: 216-267 Aderendhülse; Hülse für 4 mm ² / AWG 12; mit Kunststoffkragen; galvanisch verzinkt; Elektrolytkupfer; gasdicht aufgecrimpt; gemäß DIN 46228, Teil 4/09.90	www.wago.com/216-267
	Art-Nr.: 216-284 Aderendhülse; Hülse für 1,5 mm ² / AWG 16; mit Kunststoffkragen; galvanisch verzinkt; Elektrolytkupfer; gasdicht aufgecrimpt; gemäß DIN 46228, Teil 4/09.90	www.wago.com/216-284
	Art-Nr.: 216-286 Aderendhülse; Hülse für 2,5 mm ² / AWG 14; mit Kunststoffkragen; galvanisch verzinkt; Elektrolytkupfer; gasdicht aufgecrimpt; gemäß DIN 46228, Teil 4/09.90	www.wago.com/216-286
	Art-Nr.: 216-287 Aderendhülse; Hülse für 4 mm ² / AWG 12; mit Kunststoffkragen; galvanisch verzinkt; Elektrolytkupfer; gasdicht aufgecrimpt; gemäß DIN 46228, Teil 4/09.90	www.wago.com/216-287
	Art-Nr.: 216-288 Aderendhülse; Hülse für 6 mm ² / AWG 10; mit Kunststoffkragen; galvanisch verzinkt; Elektrolytkupfer; gasdicht aufgecrimpt; gemäß DIN 46228, Teil 4/09.90	www.wago.com/216-288



Art-Nr.: 216-289

Aderendhülse; Hülse für 10 mm² / AWG 8; mit Kunststoffkragen; galvanisch verzinkt; Elektrolytkupfer; gasdicht aufgecrimpt; gemäß DIN 46228, Teil 4/09.90 www.wago.com/216-289



Art-Nr.: 216-301

Aderendhülse; Hülse für 0,25 mm² / AWG 24; mit Kunststoffkragen; galvanisch verzinkt www.wago.com/216-301



Art-Nr.: 216-302

Aderendhülse; Hülse für 0,34 mm² / AWG 24; mit Kunststoffkragen; galvanisch verzinkt www.wago.com/216-302



Art-Nr.: 216-321

Aderendhülse; Hülse für 0,25 mm² / AWG 24; mit Kunststoffkragen; galvanisch verzinkt www.wago.com/216-321



Art-Nr.: 216-322

Aderendhülse; Hülse für 0,34 mm² / AWG 24; mit Kunststoffkragen; galvanisch verzinkt www.wago.com/216-322

Downloads

Dokumentation

Ausschreibungstext

262-108	Oct 11, 2017	DOC 25,1 kB	Download
---------	--------------	----------------	----------

smartDATA

CAD Daten

3D Download 262-108	URL	Download
---------------------	-----	----------

Änderungen vorbehalten.

WAGO Kontakttechnik GmbH & Co. KG
 Hansastr. 27
 32423 Minden
 Telefon: +49571 887-0
 E-Mail: info.de@wago.com | Web: www.wago.com

Haben Sie Fragen zu unseren Produkten?
 Wir stehen Ihnen telefonisch unter +49 (571) 887-44222 gern zur Verfügung.