

## Datenblatt | Artikelnummer: 262-258

4-Leiter-Klemmenleiste; mit Rastfüßen; für Blechdicke 0,6 - 1,2 mm;  
Befestigungsloch Ø 3,5 mm; auch auf Alu-Schiene 210-154 oder mit  
Montagefuß 209-120 auf TS 35; 8-polig

[www.wago.com/262-258](http://www.wago.com/262-258)

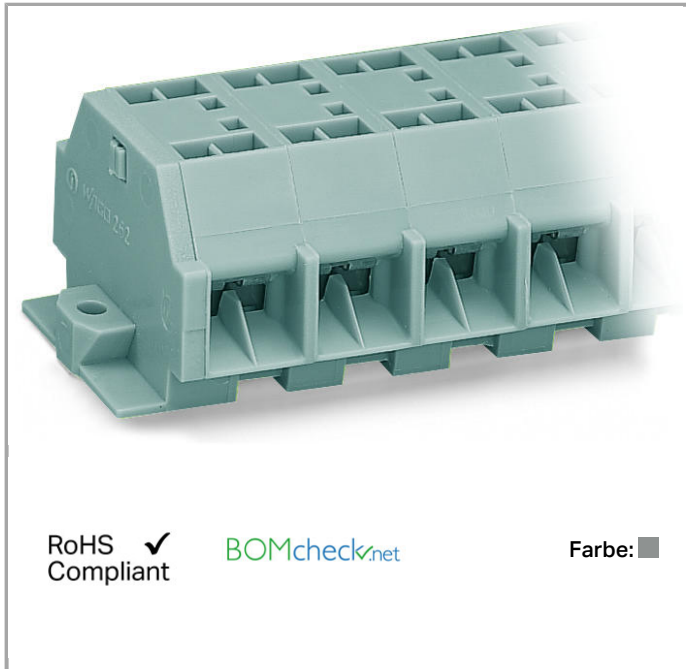

RoHS   
Compliant

Farbe:

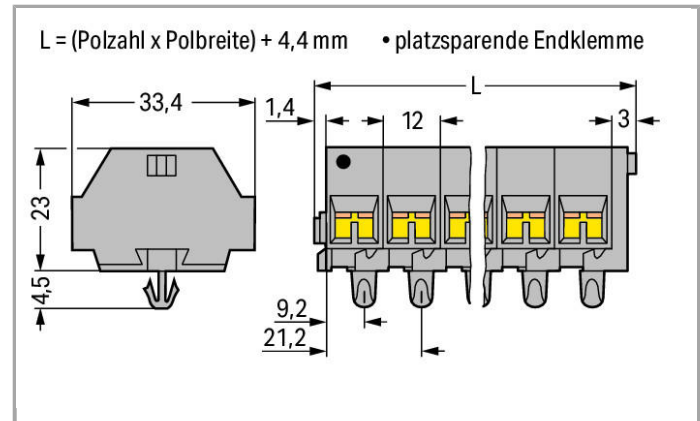

### Daten

#### Elektrische Daten

#### Bemessungsdaten gemäß IEC/EN 60664-1

Bemessungsspannung (III / 3)	630 V
Bemessungsstoßspannung (III / 3)	8 kV
Bemessungsstrom	32 A
Legende Bemessungsdaten	(III / 3) ≙ Überspannungskategorie III / Verschmutzungsgrad 3

#### Anschlussdaten

Anschlusstechnik	CAGE CLAMP®
Betätigungsart	Betätigungswerkzeug
Anschließbare Leiterwerkstoffe	Kupfer Aluminium
Eindrähtiger Leiter	0,08 ... 4 mm <sup>2</sup> / 28 ... 12 AWG
Feindrähtiger Leiter	0,08 ... 4 mm <sup>2</sup> / 28 ... 12 AWG
Abisolierlänge	9 ... 10 mm / 0.35 ... 0.39 inch
Polzahl	8
Gesamte Anzahl der Klemmstellen	32

Gesamte Anzahl der Potentiale	8
Anzahl der Ebenen	1
Verdrahtungsart	Seitliche Verdrahtung

### Geometrische Daten

Breite	100,4 mm / 3.953 inch
Höhe ab Oberfläche	23 mm / 0.906 inch
Tiefe	33,5 mm / 1.319 inch

### Mechanische Daten

Bauform	horizontale Bauform
Befestigungsart	Rastfuß
Beschriftungsebene	Seitliche Beschriftung

### Werkstoffdaten

Farbe	grau
Brandlast	0.936 MJ
Gewicht	57.139 g

### Kaufmännische Daten

Ursprungsland	DE
GTIN	4044918641722
Zolltarifnummer	85369010000
eCl@ss 9.0	27-14-11-06
eCl@ss 8.0	27-14-11-06
ETIM 6.0	EC001284
ETIM 5.0	EC001284

### Zulassungen / Zertifikate

#### Länderspezifische Zulassungen

Logo	Zulassung	Zertifikatsname
	CCA DEKRA Certification B.V.	NTR-NL 6510
	CCA DEKRA Certification B.V.	2110272.03
	CSA DEKRA Certification B.V.	70010891



## Schiff Zulassungen





Logo	Zulassung	Zertifikatsname
	<b>ABS</b> American Bureau of Shipping	14-HG1241539-PDA
	<b>BV</b> Bureau Veritas S.A.	07436/E0 BV
	<b>LR</b> Lloyds Register	91/20242 (E7)

## UL-Zulassungen

Logo	Zulassung	Zertifikatsname
	<b>UR</b> Underwriters Laboratories Inc.	E45172

## Passende Produkte

## Werkzeug

	<b>Art-Nr.: 209-132</b> Betätigungswerkzeug; zum Anschließen der Einlegebrücke; 2-fach; aus Isolierstoff	<a href="http://www.wago.com/209-132">www.wago.com/209-132</a>
	<b>Art-Nr.: 210-657</b> Betätigungswerkzeug mit teilisoliertem Schaft; Klinge (3,5 x 0,5) mm; kurz	<a href="http://www.wago.com/210-657">www.wago.com/210-657</a>
	<b>Art-Nr.: 210-658</b> Betätigungswerkzeug mit teilisoliertem Schaft; Klinge (3,5 x 0,5) mm; kurz; abgewinkelt	<a href="http://www.wago.com/210-658">www.wago.com/210-658</a>
	<b>Art-Nr.: 210-720</b> Betätigungswerkzeug mit teilisoliertem Schaft; Typ 2, Klinge (3,5 x 0,5) mm	<a href="http://www.wago.com/210-720">www.wago.com/210-720</a>

## Allgemeines Zubehör

	<b>Art-Nr.: 209-122</b> Kunststoffendklammer; mit WSB beschriftbar; für Alu-Schiene 210-154	<a href="http://www.wago.com/209-122">www.wago.com/209-122</a>
--	--	--

## Brücken

	<b>Art-Nr.: 262-402</b> Einlegebrücke; isoliert; 2-fach; reduziert den anschließbaren Querschnitt auf 2,5 mm	<a href="http://www.wago.com/262-402">www.wago.com/262-402</a>
--	---	--

### Tragschiene

	<b>Art-Nr.: 210-154</b> Aluminiumtragschiene; 1000 mm lang; 18 mm breit; 7 mm hoch	<a href="http://www.wago.com/210-154">www.wago.com/210-154</a>
--	---	--

### Prüfen und Messen

	<b>Art-Nr.: 210-136</b> Prüfstecker; Ø 2 mm; mit 500mm-Leitung	<a href="http://www.wago.com/210-136">www.wago.com/210-136</a>
--	---	--

	<b>Art-Nr.: 210-137</b> Prüfstecker; Ø 2,3 mm; mit 500mm-Leitung	<a href="http://www.wago.com/210-137">www.wago.com/210-137</a>
--	---	--

	<b>Art-Nr.: 249-140</b> Prüfsteckermodul; ohne Rastklinken; anreihbar; für 4-Leiter-Klemmen	<a href="http://www.wago.com/249-140">www.wago.com/249-140</a>
--	--	--

### Aderendhülse

	<b>Art-Nr.: 216-101</b> Aderendhülse; Hülse für 0,5 mm <sup>2</sup> / AWG 22; ohne Kunststoffkragen; galvanisch verzinkt	<a href="http://www.wago.com/216-101">www.wago.com/216-101</a>
--	---	--

	<b>Art-Nr.: 216-102</b> Aderendhülse; Hülse für 0,75 mm <sup>2</sup> / AWG 20; ohne Kunststoffkragen; galvanisch verzinkt	<a href="http://www.wago.com/216-102">www.wago.com/216-102</a>
--	--	--

	<b>Art-Nr.: 216-103</b> Aderendhülse; Hülse für 1 mm <sup>2</sup> / AWG 18; ohne Kunststoffkragen; galvanisch verzinkt	<a href="http://www.wago.com/216-103">www.wago.com/216-103</a>
---	---	--

	<b>Art-Nr.: 216-104</b> Aderendhülse; Hülse für 1,5 mm <sup>2</sup> / AWG 16; ohne Kunststoffkragen; galvanisch verzinkt	<a href="http://www.wago.com/216-104">www.wago.com/216-104</a>
--	---	--

	<b>Art-Nr.: 216-108</b> Aderendhülse; Hülse für 6 mm <sup>2</sup> / AWG 10; ohne Kunststoffkragen; galvanisch verzinkt	<a href="http://www.wago.com/216-108">www.wago.com/216-108</a>
--	---	--

	<b>Art-Nr.: 216-109</b> Aderendhülse; Hülse für 10 mm <sup>2</sup> / AWG 8; ohne Kunststoffkragen; galvanisch verzinkt	<a href="http://www.wago.com/216-109">www.wago.com/216-109</a>
--	---	--

	<b>Art-Nr.: 216-110</b> Aderendhülse; Hülse für 16 mm <sup>2</sup> / AWG 6; ohne Kunststoffkragen; galvanisch verzinkt	<a href="http://www.wago.com/216-110">www.wago.com/216-110</a>
--	---	--

	<b>Art-Nr.: 216-121</b> Aderendhülse; Hülse für 0,5 mm <sup>2</sup> / AWG 22; ohne Kunststoffkragen; galvanisch verzinkt	<a href="http://www.wago.com/216-121">www.wago.com/216-121</a>
--	---	--

	<b>Art-Nr.: 216-122</b> Aderendhülse; Hülse für 0,75 mm <sup>2</sup> / AWG 20; ohne Kunststoffkragen; galvanisch verzinkt	<a href="http://www.wago.com/216-122">www.wago.com/216-122</a>
--	--	--



















	<b>Art-Nr.: 216-123</b> Aderendhülse; Hülse für 1 mm <sup>2</sup> / AWG 18; ohne Kunststoffkragen; galvanisch verzinkt	<a href="http://www.wago.com/216-123">www.wago.com/216-123</a>
--	---	--



















	<b>Art-Nr.: 216-124</b> Aderendhülse; Hülse für 1,5 mm <sup>2</sup> / AWG 16; ohne Kunststoffkragen; galvanisch verzinkt	<a href="http://www.wago.com/216-124">www.wago.com/216-124</a>
--	---	--

	<b>Art-Nr.: 216-131</b> Aderendhülse; Hülse für 0,25 mm <sup>2</sup> / AWG 24; ohne Kunststoffkragen; galvanisch verzinkt	<a href="http://www.wago.com/216-131">www.wago.com/216-131</a>
--	--	--

	<b>Art-Nr.: 216-132</b> Aderendhülse; Hülse für 0,34 mm <sup>2</sup> / AWG 24; ohne Kunststoffkragen; galvanisch verzinkt	<a href="http://www.wago.com/216-132">www.wago.com/216-132</a>
--	--	--

**Art-Nr.: 216-141**

	Aderendhülse; Hülse für 0,5 mm <sup>2</sup> / AWG 22; ohne Kunststoffkragen; galvanisch verzinkt; Elektrolytkupfer; gasdicht aufgecrimpt; gemäß DIN 46228, Teil 1/08.92	<a href="http://www.wago.com/216-141">www.wago.com/216-141</a>
	<b>Art-Nr.: 216-142</b>	
	Aderendhülse; Hülse für 0,75 mm <sup>2</sup> / AWG 20; ohne Kunststoffkragen; galvanisch verzinkt; Elektrolytkupfer; gasdicht aufgecrimpt; gemäß DIN 46228, Teil 1/08.92	<a href="http://www.wago.com/216-142">www.wago.com/216-142</a>
	<b>Art-Nr.: 216-143</b>	
	Aderendhülse; Hülse für 1 mm <sup>2</sup> / AWG 18; ohne Kunststoffkragen; galvanisch verzinkt; Elektrolytkupfer; gasdicht aufgecrimpt; gemäß DIN 46228, Teil 1/08.92	<a href="http://www.wago.com/216-143">www.wago.com/216-143</a>
	<b>Art-Nr.: 216-144</b>	
	Aderendhülse; Hülse für 1,5 mm <sup>2</sup> / AWG 16; ohne Kunststoffkragen; galvanisch verzinkt; Elektrolytkupfer; gasdicht aufgecrimpt; gemäß DIN 46228, Teil 1/08.92	<a href="http://www.wago.com/216-144">www.wago.com/216-144</a>
	<b>Art-Nr.: 216-151</b>	
	Aderendhülse; Hülse für 0,25 mm <sup>2</sup> / AWG 24; ohne Kunststoffkragen; galvanisch verzinkt	<a href="http://www.wago.com/216-151">www.wago.com/216-151</a>
	<b>Art-Nr.: 216-152</b>	
	Aderendhülse; Hülse für 0,34 mm <sup>2</sup> / AWG 24; ohne Kunststoffkragen; galvanisch verzinkt	<a href="http://www.wago.com/216-152">www.wago.com/216-152</a>
	<b>Art-Nr.: 216-201</b>	
	Aderendhülse; Hülse für 0,5 mm <sup>2</sup> / AWG 22; mit Kunststoffkragen; galvanisch verzinkt	<a href="http://www.wago.com/216-201">www.wago.com/216-201</a>
	<b>Art-Nr.: 216-202</b>	
	Aderendhülse; Hülse für 0,75 mm <sup>2</sup> / AWG 20; mit Kunststoffkragen; galvanisch verzinkt	<a href="http://www.wago.com/216-202">www.wago.com/216-202</a>
	<b>Art-Nr.: 216-203</b>	
	Aderendhülse; Hülse für 1 mm <sup>2</sup> / AWG 18; mit Kunststoffkragen; galvanisch verzinkt	<a href="http://www.wago.com/216-203">www.wago.com/216-203</a>
	<b>Art-Nr.: 216-204</b>	
	Aderendhülse; Hülse für 1,5 mm <sup>2</sup> / AWG 16; mit Kunststoffkragen; galvanisch verzinkt	<a href="http://www.wago.com/216-204">www.wago.com/216-204</a>
	<b>Art-Nr.: 216-205</b>	
	Aderendhülse; Hülse für 2,08 mm <sup>2</sup> / AWG 14; mit Kunststoffkragen; galvanisch verzinkt	<a href="http://www.wago.com/216-205">www.wago.com/216-205</a>
	<b>Art-Nr.: 216-206</b>	
	Aderendhülse; Hülse für 2,5 mm <sup>2</sup> / AWG 14; mit Kunststoffkragen; galvanisch verzinkt	<a href="http://www.wago.com/216-206">www.wago.com/216-206</a>
	<b>Art-Nr.: 216-208</b>	
	Aderendhülse; Hülse für 6 mm <sup>2</sup> / AWG 10; mit Kunststoffkragen; galvanisch verzinkt; Elektrolytkupfer; gasdicht aufgecrimpt; gemäß DIN 46228, Teil 4/09.90	<a href="http://www.wago.com/216-208">www.wago.com/216-208</a>
	<b>Art-Nr.: 216-209</b>	
	Aderendhülse; Hülse für 10 mm <sup>2</sup> / AWG 8; mit Kunststoffkragen; galvanisch verzinkt	<a href="http://www.wago.com/216-209">www.wago.com/216-209</a>
	<b>Art-Nr.: 216-210</b>	
	Aderendhülse; Hülse für 16 mm <sup>2</sup> / AWG 6; mit Kunststoffkragen; galvanisch verzinkt; Elektrolytkupfer; gasdicht aufgecrimpt; gemäß DIN 46228, Teil 4/09.90	<a href="http://www.wago.com/216-210">www.wago.com/216-210</a>
	<b>Art-Nr.: 216-221</b>	
	Aderendhülse; Hülse für 0,5 mm <sup>2</sup> / AWG 22; mit Kunststoffkragen; galvanisch verzinkt	<a href="http://www.wago.com/216-221">www.wago.com/216-221</a>
	<b>Art-Nr.: 216-222</b>	
	Aderendhülse; Hülse für 0,75 mm <sup>2</sup> / AWG 20; mit Kunststoffkragen; galvanisch verzinkt	<a href="http://www.wago.com/216-222">www.wago.com/216-222</a>
	<b>Art-Nr.: 216-223</b>	
	Aderendhülse; Hülse für 1 mm <sup>2</sup> / AWG 18; mit Kunststoffkragen; galvanisch verzinkt	<a href="http://www.wago.com/216-223">www.wago.com/216-223</a>
	<b>Art-Nr.: 216-224</b>	
	Aderendhülse; Hülse für 1,5 mm <sup>2</sup> / AWG 16; mit Kunststoffkragen; galvanisch verzinkt	<a href="http://www.wago.com/216-224">www.wago.com/216-224</a>
	<b>Art-Nr.: 216-241</b>	

	Aderendhülse; Hülse für 0,5 mm <sup>2</sup> / AWG 22; mit Kunststoffkragen; galvanisch verzinkt; Elektrolytkupfer; <a href="http://www.wago.com/216-241">www.wago.com/216-241</a> gasdicht aufgecrimpt; gemäß DIN 46228, Teil 4/09.90
	<b>Art-Nr.: 216-242</b> Aderendhülse; Hülse für 0,75 mm <sup>2</sup> / AWG 20; mit Kunststoffkragen; galvanisch verzinkt; Elektrolytkupfer; <a href="http://www.wago.com/216-242">www.wago.com/216-242</a> gasdicht aufgecrimpt; gemäß DIN 46228, Teil 4/09.90
	<b>Art-Nr.: 216-243</b> Aderendhülse; Hülse für 1 mm <sup>2</sup> / AWG 18; mit Kunststoffkragen; galvanisch verzinkt; Elektrolytkupfer; <a href="http://www.wago.com/216-243">www.wago.com/216-243</a> gasdicht aufgecrimpt; gemäß DIN 46228, Teil 4/09.90
	<b>Art-Nr.: 216-244</b> Aderendhülse; Hülse für 1,5 mm <sup>2</sup> / AWG 16; mit Kunststoffkragen; galvanisch verzinkt; Elektrolytkupfer; <a href="http://www.wago.com/216-244">www.wago.com/216-244</a> gasdicht aufgecrimpt; gemäß DIN 46228, Teil 4/09.90
	<b>Art-Nr.: 216-246</b> Aderendhülse; Hülse für 2,5 mm <sup>2</sup> / AWG 14; mit Kunststoffkragen; galvanisch verzinkt; Elektrolytkupfer; <a href="http://www.wago.com/216-246">www.wago.com/216-246</a> gasdicht aufgecrimpt; gemäß DIN 46228, Teil 4/09.90
	<b>Art-Nr.: 216-262</b> Aderendhülse; Hülse für 0,75 mm <sup>2</sup> / AWG 20; mit Kunststoffkragen; galvanisch verzinkt; Elektrolytkupfer; <a href="http://www.wago.com/216-262">www.wago.com/216-262</a> gasdicht aufgecrimpt; gemäß DIN 46228, Teil 4/09.90
	<b>Art-Nr.: 216-263</b> Aderendhülse; Hülse für 1 mm <sup>2</sup> / AWG 18; mit Kunststoffkragen; galvanisch verzinkt; Elektrolytkupfer; <a href="http://www.wago.com/216-263">www.wago.com/216-263</a> gasdicht aufgecrimpt; gemäß DIN 46228, Teil 4/09.90
	<b>Art-Nr.: 216-264</b> Aderendhülse; Hülse für 1,5 mm <sup>2</sup> / AWG 16; mit Kunststoffkragen; galvanisch verzinkt; Elektrolytkupfer; <a href="http://www.wago.com/216-264">www.wago.com/216-264</a> gasdicht aufgecrimpt; gemäß DIN 46228, Teil 4/09.90
	<b>Art-Nr.: 216-266</b> Aderendhülse; Hülse für 2,5 mm <sup>2</sup> / AWG 14; mit Kunststoffkragen; galvanisch verzinkt; Elektrolytkupfer; <a href="http://www.wago.com/216-266">www.wago.com/216-266</a> gasdicht aufgecrimpt; gemäß DIN 46228, Teil 4/09.90
	<b>Art-Nr.: 216-267</b> Aderendhülse; Hülse für 4 mm <sup>2</sup> / AWG 12; mit Kunststoffkragen; galvanisch verzinkt; Elektrolytkupfer; <a href="http://www.wago.com/216-267">www.wago.com/216-267</a> gasdicht aufgecrimpt; gemäß DIN 46228, Teil 4/09.90
	<b>Art-Nr.: 216-284</b> Aderendhülse; Hülse für 1,5 mm <sup>2</sup> / AWG 16; mit Kunststoffkragen; galvanisch verzinkt; Elektrolytkupfer; <a href="http://www.wago.com/216-284">www.wago.com/216-284</a> gasdicht aufgecrimpt; gemäß DIN 46228, Teil 4/09.90
	<b>Art-Nr.: 216-286</b> Aderendhülse; Hülse für 2,5 mm <sup>2</sup> / AWG 14; mit Kunststoffkragen; galvanisch verzinkt; Elektrolytkupfer; <a href="http://www.wago.com/216-286">www.wago.com/216-286</a> gasdicht aufgecrimpt; gemäß DIN 46228, Teil 4/09.90
	<b>Art-Nr.: 216-287</b> Aderendhülse; Hülse für 4 mm <sup>2</sup> / AWG 12; mit Kunststoffkragen; galvanisch verzinkt; Elektrolytkupfer; <a href="http://www.wago.com/216-287">www.wago.com/216-287</a> gasdicht aufgecrimpt; gemäß DIN 46228, Teil 4/09.90
	<b>Art-Nr.: 216-288</b> Aderendhülse; Hülse für 6 mm <sup>2</sup> / AWG 10; mit Kunststoffkragen; galvanisch verzinkt; Elektrolytkupfer; <a href="http://www.wago.com/216-288">www.wago.com/216-288</a> gasdicht aufgecrimpt; gemäß DIN 46228, Teil 4/09.90
	<b>Art-Nr.: 216-289</b> Aderendhülse; Hülse für 10 mm <sup>2</sup> / AWG 8; mit Kunststoffkragen; galvanisch verzinkt; Elektrolytkupfer; <a href="http://www.wago.com/216-289">www.wago.com/216-289</a> gasdicht aufgecrimpt; gemäß DIN 46228, Teil 4/09.90
	<b>Art-Nr.: 216-301</b> Aderendhülse; Hülse für 0,25 mm <sup>2</sup> / AWG 24; mit Kunststoffkragen; galvanisch verzinkt <a href="http://www.wago.com/216-301">www.wago.com/216-301</a>
	<b>Art-Nr.: 216-302</b> Aderendhülse; Hülse für 0,34 mm <sup>2</sup> / AWG 24; mit Kunststoffkragen; galvanisch verzinkt <a href="http://www.wago.com/216-302">www.wago.com/216-302</a>
	<b>Art-Nr.: 216-321</b> Aderendhülse; Hülse für 0,25 mm <sup>2</sup> / AWG 24; mit Kunststoffkragen; galvanisch verzinkt <a href="http://www.wago.com/216-321">www.wago.com/216-321</a>



Art-Nr.: 216-322

Aderendhülse; Hülse für 0,34 mm<sup>2</sup> / AWG 24; mit Kunststoffkragen; galvanisch verzinkt

[www.wago.com/216-322](http://www.wago.com/216-322)

## Montage



Art-Nr.: 209-120

Montagefuß; an Klemmen mit Rastfuß anrastbar; zum Anschrauben an die Relaisbausteine; 6,4 mm breit

[www.wago.com/209-120](http://www.wago.com/209-120)

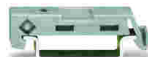

Art-Nr.: 209-137

Montageadapter; als Endklammer verwendbar; 6,5 mm breit

[www.wago.com/209-137](http://www.wago.com/209-137)

## Downloads

### Dokumentation

#### Ausschreibungstext

262-258	Oct 11, 2017	DOC 26,1 kB	Download
---------	--------------	----------------	----------

## smartDATA

### CAD Daten

3D Download 262-258	URL	Download
---------------------	-----	----------

Änderungen vorbehalten.

WAGO Kontakttechnik GmbH & Co. KG  
Hansastr. 27  
32423 Minden  
Telefon: +49571 887-0  
E-Mail: [info.de@wago.com](mailto:info.de@wago.com) | Web: [www.wago.com](http://www.wago.com)

Haben Sie Fragen zu unseren Produkten?  
Wir stehen Ihnen telefonisch unter +49 (571) 887-44222 gern zur  
Verfügung.