

## Datenblatt | Artikelnummer: 264-154

2-Leiter-Klemmenleiste; mit Rastfüßen; für Blechdicke 0,6 - 1,2 mm;  
Befestigungsloch Ø 3,5 mm; auch auf Alu-Schiene 210-154 oder mit  
Montagefuß 209-120 auf TS 35; 4-polig

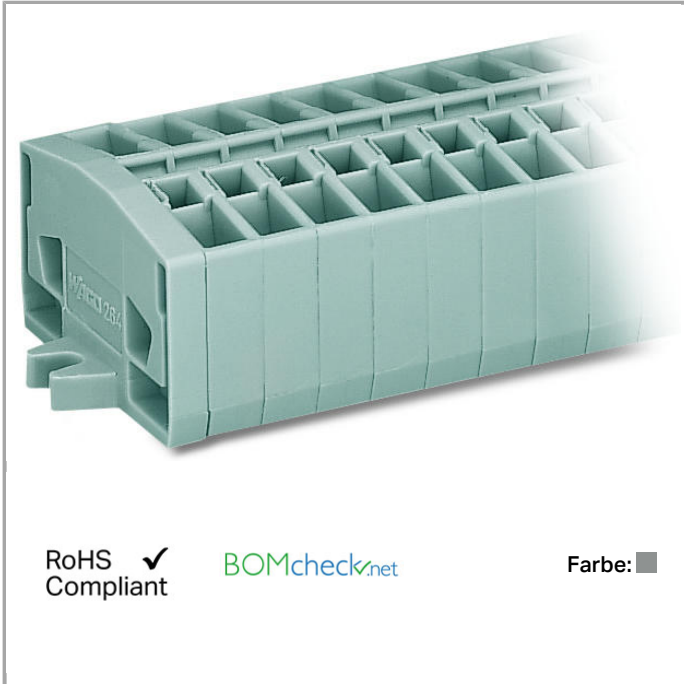

[www.wago.com/264-154](http://www.wago.com/264-154)



RoHS  Compliant

BOMcheck.net

Farbe: ■

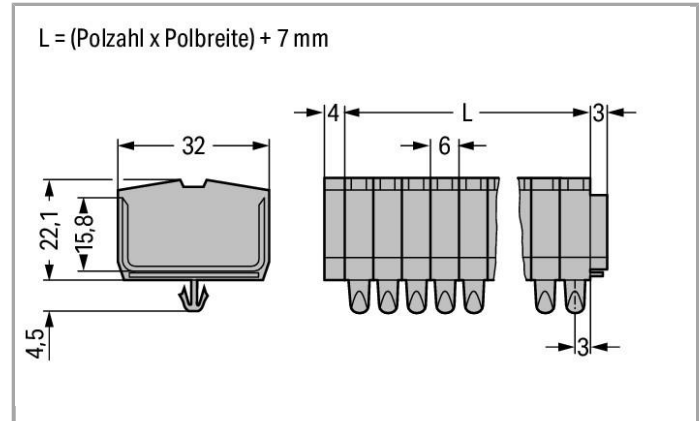

### Daten

#### Elektrische Daten

#### Bemessungsdaten gemäß IEC/EN 60664-1

Bemessungsspannung (III / 3)	800 V
Bemessungsstoßspannung (III / 3)	8 kV
Bemessungsstrom	24 A
Legende Bemessungsdaten	(III / 3) ≙ Überspannungskategorie III / Verschmutzungsgrad 3

#### Anschlussdaten

Anschlusstechnik	CAGE CLAMP®
Betätigungsart	Betätigungswerkzeug
Anschließbare Leiterwerkstoffe	Kupfer Aluminium
Eindrähtiger Leiter	0,08 ... 2,5 mm <sup>2</sup> / 28 ... 12 AWG
Feindrähtiger Leiter	0,08 ... 2,5 mm <sup>2</sup> / 28 ... 12 AWG
Abisolierlänge	8 ... 9 mm / 0.31 ... 0.35 inch
Polzahl	4
Gesamte Anzahl der Klemmstellen	8

Gesamte Anzahl der Potentiale	4
Anzahl der Ebenen	1
Verdrahtungsart	Frontverdrahtung

### Geometrische Daten

Breite	31 mm / 1.22 inch
Höhe ab Oberfläche	22,1 mm / 0.87 inch
Tiefe	32 mm / 1.26 inch

### Mechanische Daten

Bauform	horizontale Bauform
Befestigungsart	Rastfuß
Beschriftungsebene	Mittenbeschriftung

### Werkstoffdaten

Farbe	grau
Brandlast	0.36 MJ
Gewicht	17.416 g



### Kaufmännische Daten

Ursprungsland	DE
GTIN	4044918423632
Zolltarifnummer	85369010000
Produktgruppe	9 (Mini-Klemmen)
eCl@ss 9.0	27-14-11-06
eCl@ss 8.0	27-14-11-06
ETIM 6.0	EC001284
ETIM 5.0	EC001284



### Zulassungen / Zertifikate

#### Länderspezifische Zulassungen

Logo	Zulassung	Zertifikatsname
	<b>CB</b> DEKRA Certification B.V.	NL-49768
	<b>CCA</b> DEKRA Certification B.V.	NTR NL-7342
	<b>CCA</b> DEKRA Certification B.V.	2175624.01

	<b>CCA</b> DEKRA Certification B.V.	NTR NL-7342
	<b>CSA</b> DEKRA Certification B.V.	70010891

**Schiff Zulassungen**

Logo	Zulassung	Zertifikatsname
	<b>ABS</b> American Bureau of Shipping	14-HG1241539-PDA
	<b>DNV GL</b> Det Norske Veritas, Germanischer Lloyd	TAE00001V2
	<b>LR</b> Lloyds Register	91/20242 (E7)

**UL-Zulassungen**



Logo	Zulassung	Zertifikatsname
	<b>UR</b> Underwriters Laboratories Inc.	E45172, sec. 6















**Passende Produkte**

**Montage**



	<b>Art-Nr.: 709-153</b> Abdeckprofil; Typ 1; passend zu Abdeckprofilträger Typ 1; 1 m lang	<a href="http://www.wago.com/709-153">www.wago.com/709-153</a>
--	---	--

**Beschriftungsmaterial**



	<b>Art-Nr.: 2009-145</b> Mini-WSB Inline; für smartPRINTER; auf Rolle; dehnbar 5 - 5,2 mm; unbedruckt; aufrastbar	<a href="http://www.wago.com/2009-145">www.wago.com/2009-145</a>
	<b>Art-Nr.: 2009-145/000-002</b> Mini-WSB Inline; für smartPRINTER; auf Rolle; dehnbar 5 - 5,2 mm; unbedruckt; aufrastbar	<a href="http://www.wago.com/2009-145/000-002">www.wago.com/2009-145/000-002</a>
	<b>Art-Nr.: 2009-145/000-005</b> Mini-WSB Inline; für smartPRINTER; auf Rolle; dehnbar 5 - 5,2 mm; unbedruckt; aufrastbar	<a href="http://www.wago.com/2009-145/000-005">www.wago.com/2009-145/000-005</a>

	<p><b>Art-Nr.: 2009-145/000-006</b> Mini-WSB Inline; für smartPRINTER; auf Rolle; dehnbar 5 - 5,2 mm; unbedruckt; aufrastbar</p>	<p><a href="http://www.wago.com/2009-145/000-006">www.wago.com/2009-145/000-006</a></p>
	<p><b>Art-Nr.: 2009-145/000-007</b> Mini-WSB Inline; für smartPRINTER; auf Rolle; dehnbar 5 - 5,2 mm; unbedruckt; aufrastbar</p>	<p><a href="http://www.wago.com/2009-145/000-007">www.wago.com/2009-145/000-007</a></p>
	<p><b>Art-Nr.: 2009-145/000-012</b> Mini-WSB Inline; für smartPRINTER; auf Rolle; dehnbar 5 - 5,2 mm; unbedruckt; aufrastbar</p>	<p><a href="http://www.wago.com/2009-145/000-012">www.wago.com/2009-145/000-012</a></p>
	<p><b>Art-Nr.: 2009-145/000-023</b> Mini-WSB Inline; für smartPRINTER; auf Rolle; dehnbar 5 - 5,2 mm; unbedruckt; aufrastbar</p>	<p><a href="http://www.wago.com/2009-145/000-023">www.wago.com/2009-145/000-023</a></p>
	<p><b>Art-Nr.: 2009-145/000-024</b> Mini-WSB Inline; auf Rolle; dehnbar 5 - 5,2 mm; unbedruckt; aufrastbar</p>	<p><a href="http://www.wago.com/2009-145/000-024">www.wago.com/2009-145/000-024</a></p>
	<p><b>Art-Nr.: 209-290</b> Beschriftungsstrang; nicht dehnbar; unbedruckt; aufrastbar</p>	<p><a href="http://www.wago.com/209-290">www.wago.com/209-290</a></p>
	<p><b>Art-Nr.: 248-501</b> Mini-WSB-Schnellbeschriftungssystem; unbedruckt; Schildchenbreite 5 mm; 10 Streifen à 10 Schilder pro Karte</p>	<p><a href="http://www.wago.com/248-501">www.wago.com/248-501</a></p>
	<p><b>Art-Nr.: 248-501/000-002</b> Mini-WSB-Beschriftungskarte; als Karte; nicht dehnbar; unbedruckt; aufrastbar</p>	<p><a href="http://www.wago.com/248-501/000-002">www.wago.com/248-501/000-002</a></p>
	<p><b>Art-Nr.: 248-501/000-005</b> Mini-WSB-Beschriftungskarte; als Karte; unbedruckt; aufrastbar</p>	<p><a href="http://www.wago.com/248-501/000-005">www.wago.com/248-501/000-005</a></p>
	<p><b>Art-Nr.: 248-501/000-006</b> Mini-WSB-Beschriftungskarte; als Karte; nicht dehnbar; unbedruckt; aufrastbar</p>	<p><a href="http://www.wago.com/248-501/000-006">www.wago.com/248-501/000-006</a></p>
	<p><b>Art-Nr.: 248-501/000-007</b> Mini-WSB-Beschriftungskarte; als Karte; nicht dehnbar; unbedruckt; aufrastbar</p>	<p><a href="http://www.wago.com/248-501/000-007">www.wago.com/248-501/000-007</a></p>
	<p><b>Art-Nr.: 248-501/000-012</b> Mini-WSB-Beschriftungskarte; als Karte; nicht dehnbar; unbedruckt; aufrastbar</p>	<p><a href="http://www.wago.com/248-501/000-012">www.wago.com/248-501/000-012</a></p>
	<p><b>Art-Nr.: 248-501/000-017</b> Mini-WSB-Beschriftungskarte; als Karte; nicht dehnbar; unbedruckt; aufrastbar</p>	<p><a href="http://www.wago.com/248-501/000-017">www.wago.com/248-501/000-017</a></p>
	<p><b>Art-Nr.: 248-501/000-023</b> Mini-WSB-Beschriftungskarte; als Karte; nicht dehnbar; unbedruckt; aufrastbar</p>	<p><a href="http://www.wago.com/248-501/000-023">www.wago.com/248-501/000-023</a></p>
	<p><b>Art-Nr.: 248-501/000-024</b> Mini-WSB-Beschriftungskarte; als Karte; nicht dehnbar; unbedruckt; aufrastbar</p>	<p><a href="http://www.wago.com/248-501/000-024">www.wago.com/248-501/000-024</a></p>

## Brücker

	<b>Art-Nr.: 264-402</b> Einlegebrücke; isoliert; 2-fach; reduziert anschließbaren Querschnitt auf 1,5 mm	<a href="http://www.wago.com/264-402">www.wago.com/264-402</a>
	<b>Art-Nr.: 281-492</b> Doppelteilungsbrückungskamm; isoliert; 2-fach; IN = IN Klemme	<a href="http://www.wago.com/281-492">www.wago.com/281-492</a>

## Prüfen und Messen

	<b>Art-Nr.: 210-136</b> Prüfstecker; Ø 2 mm; mit 500mm-Leitung	<a href="http://www.wago.com/210-136">www.wago.com/210-136</a>
	<b>Art-Nr.: 210-137</b> Prüfstecker; Ø 2,3 mm; mit 500mm-Leitung	<a href="http://www.wago.com/210-137">www.wago.com/210-137</a>
	<b>Art-Nr.: 249-136</b> Prüfsteckermodul; ohne Rastklinken; anreihbar; für 2-Leiter-Klemmen	<a href="http://www.wago.com/249-136">www.wago.com/249-136</a>

## Tragschiene



















	<b>Art-Nr.: 210-154</b> Aluminiumtragschiene; 1000 mm lang; 18 mm breit; 7 mm hoch	<a href="http://www.wago.com/210-154">www.wago.com/210-154</a>
--	---	--

## Allgemeines Zubehör

	<b>Art-Nr.: 209-122</b> Kunststoffendklammer; mit WSB beschriftbar; für Alu-Schiene 210-154	<a href="http://www.wago.com/209-122">www.wago.com/209-122</a>
--	--	--

## Aderendhülse

	<b>Art-Nr.: 216-101</b> Aderendhülse; Hülse für 0,5 mm <sup>2</sup> / AWG 22; ohne Kunststoffkragen; galvanisch verzinkt	<a href="http://www.wago.com/216-101">www.wago.com/216-101</a>
	<b>Art-Nr.: 216-102</b> Aderendhülse; Hülse für 0,75 mm <sup>2</sup> / AWG 20; ohne Kunststoffkragen; galvanisch verzinkt	<a href="http://www.wago.com/216-102">www.wago.com/216-102</a>
	<b>Art-Nr.: 216-103</b> Aderendhülse; Hülse für 1 mm <sup>2</sup> / AWG 18; ohne Kunststoffkragen; galvanisch verzinkt	<a href="http://www.wago.com/216-103">www.wago.com/216-103</a>
	<b>Art-Nr.: 216-104</b> Aderendhülse; Hülse für 1,5 mm <sup>2</sup> / AWG 16; ohne Kunststoffkragen; galvanisch verzinkt	<a href="http://www.wago.com/216-104">www.wago.com/216-104</a>
	<b>Art-Nr.: 216-106</b> Aderendhülse; Hülse für 2,5 mm <sup>2</sup> / AWG 14; ohne Kunststoffkragen; galvanisch verzinkt	<a href="http://www.wago.com/216-106">www.wago.com/216-106</a>
	<b>Art-Nr.: 216-121</b> Aderendhülse; Hülse für 0,5 mm <sup>2</sup> / AWG 22; ohne Kunststoffkragen; galvanisch verzinkt	<a href="http://www.wago.com/216-121">www.wago.com/216-121</a>
	<b>Art-Nr.: 216-122</b> Aderendhülse; Hülse für 0,75 mm <sup>2</sup> / AWG 20; ohne Kunststoffkragen; galvanisch verzinkt	<a href="http://www.wago.com/216-122">www.wago.com/216-122</a>
	<b>Art-Nr.: 216-123</b> Aderendhülse; Hülse für 1 mm <sup>2</sup> / AWG 18; ohne Kunststoffkragen; galvanisch verzinkt	<a href="http://www.wago.com/216-123">www.wago.com/216-123</a>
	<b>Art-Nr.: 216-124</b> Aderendhülse; Hülse für 1,5 mm <sup>2</sup> / AWG 16; ohne Kunststoffkragen; galvanisch verzinkt	<a href="http://www.wago.com/216-124">www.wago.com/216-124</a>

	<b>Art-Nr.: 216-131</b> Aderendhülse; Hülse für 0,25 mm <sup>2</sup> / AWG 24; ohne Kunststoffkragen; galvanisch verzinkt	<a href="http://www.wago.com/216-131">www.wago.com/216-131</a>
	<b>Art-Nr.: 216-132</b> Aderendhülse; Hülse für 0,34 mm <sup>2</sup> / AWG 24; ohne Kunststoffkragen; galvanisch verzinkt	<a href="http://www.wago.com/216-132">www.wago.com/216-132</a>
	<b>Art-Nr.: 216-151</b> Aderendhülse; Hülse für 0,25 mm <sup>2</sup> / AWG 24; ohne Kunststoffkragen; galvanisch verzinkt	<a href="http://www.wago.com/216-151">www.wago.com/216-151</a>
	<b>Art-Nr.: 216-152</b> Aderendhülse; Hülse für 0,34 mm <sup>2</sup> / AWG 24; ohne Kunststoffkragen; galvanisch verzinkt	<a href="http://www.wago.com/216-152">www.wago.com/216-152</a>
	<b>Art-Nr.: 216-201</b> Aderendhülse; Hülse für 0,5 mm <sup>2</sup> / AWG 22; mit Kunststoffkragen; galvanisch verzinkt	<a href="http://www.wago.com/216-201">www.wago.com/216-201</a>
	<b>Art-Nr.: 216-202</b> Aderendhülse; Hülse für 0,75 mm <sup>2</sup> / AWG 20; mit Kunststoffkragen; galvanisch verzinkt	<a href="http://www.wago.com/216-202">www.wago.com/216-202</a>
	<b>Art-Nr.: 216-203</b> Aderendhülse; Hülse für 1 mm <sup>2</sup> / AWG 18; mit Kunststoffkragen; galvanisch verzinkt	<a href="http://www.wago.com/216-203">www.wago.com/216-203</a>
	<b>Art-Nr.: 216-204</b> Aderendhülse; Hülse für 1,5 mm <sup>2</sup> / AWG 16; mit Kunststoffkragen; galvanisch verzinkt	<a href="http://www.wago.com/216-204">www.wago.com/216-204</a>
	<b>Art-Nr.: 216-205</b> Aderendhülse; Hülse für 2,08 mm <sup>2</sup> / AWG 14; mit Kunststoffkragen; galvanisch verzinkt	<a href="http://www.wago.com/216-205">www.wago.com/216-205</a>
	<b>Art-Nr.: 216-206</b> Aderendhülse; Hülse für 2,5 mm <sup>2</sup> / AWG 14; mit Kunststoffkragen; galvanisch verzinkt	<a href="http://www.wago.com/216-206">www.wago.com/216-206</a>
	<b>Art-Nr.: 216-221</b> Aderendhülse; Hülse für 0,5 mm <sup>2</sup> / AWG 22; mit Kunststoffkragen; galvanisch verzinkt	<a href="http://www.wago.com/216-221">www.wago.com/216-221</a>
	<b>Art-Nr.: 216-222</b> Aderendhülse; Hülse für 0,75 mm <sup>2</sup> / AWG 20; mit Kunststoffkragen; galvanisch verzinkt	<a href="http://www.wago.com/216-222">www.wago.com/216-222</a>
	<b>Art-Nr.: 216-223</b> Aderendhülse; Hülse für 1 mm <sup>2</sup> / AWG 18; mit Kunststoffkragen; galvanisch verzinkt	<a href="http://www.wago.com/216-223">www.wago.com/216-223</a>
	<b>Art-Nr.: 216-224</b> Aderendhülse; Hülse für 1,5 mm <sup>2</sup> / AWG 16; mit Kunststoffkragen; galvanisch verzinkt	<a href="http://www.wago.com/216-224">www.wago.com/216-224</a>
	<b>Art-Nr.: 216-321</b> Aderendhülse; Hülse für 0,25 mm <sup>2</sup> / AWG 24; mit Kunststoffkragen; galvanisch verzinkt	<a href="http://www.wago.com/216-321">www.wago.com/216-321</a>
	<b>Art-Nr.: 216-322</b> Aderendhülse; Hülse für 0,34 mm <sup>2</sup> / AWG 24; mit Kunststoffkragen; galvanisch verzinkt	<a href="http://www.wago.com/216-322">www.wago.com/216-322</a>
<b>Werkzeug</b>		
	<b>Art-Nr.: 209-130</b> Betätigungswerkzeug; passend zu Serie 264, 280, 281; 1-fach; aus Isolierstoff	<a href="http://www.wago.com/209-130">www.wago.com/209-130</a>
	<b>Art-Nr.: 210-657</b> Betätigungswerkzeug mit teilisoliertem Schaft; Klinge (3,5 x 0,5) mm; kurz	<a href="http://www.wago.com/210-657">www.wago.com/210-657</a>
	<b>Art-Nr.: 210-658</b> Betätigungswerkzeug mit teilisoliertem Schaft; Klinge (3,5 x 0,5) mm; kurz; abgewinkelt	<a href="http://www.wago.com/210-658">www.wago.com/210-658</a>



Art-Nr.: 210-720

Betätigungswerkzeug mit teilisoliertem Schaft; Typ 2, Klinge (3,5 x 0,5) mm

[www.wago.com/210-720](http://www.wago.com/210-720)



Art-Nr.: 280-432

Betätigungswerkzeug; aus Isolierstoff; 2-fach

[www.wago.com/280-432](http://www.wago.com/280-432)

## Downloads

### Dokumentation

#### Ausschreibungstext

264-154	Oct 11, 2017	DOC 25,6 kB	Download
---------	--------------	----------------	----------

## smartDATA

### CAD Daten

3D Download 264-154	URL	Download
---------------------	-----	----------

Änderungen vorbehalten.

WAGO Kontakttechnik GmbH & Co. KG  
Hansastr. 27  
32423 Minden  
Telefon: +49571 887-0  
E-Mail: [info.de@wago.com](mailto:info.de@wago.com) | Web: [www.wago.com](http://www.wago.com)

Haben Sie Fragen zu unseren Produkten?  
Wir stehen Ihnen telefonisch unter +49 (571) 887-44222 gern zur  
Verfügung.