

Datenblatt | Artikelnummer: 264-252

4-Leiter-Klemmenleiste; mit Rastfüßen; für Blechdicke 0,6 - 1,2 mm;
Befestigungsloch Ø 3,5 mm; auch auf Alu-Schiene 210-154 oder mit
Montagefuß 209-120 auf TS 35; 2-polig

www.wago.com/264-252

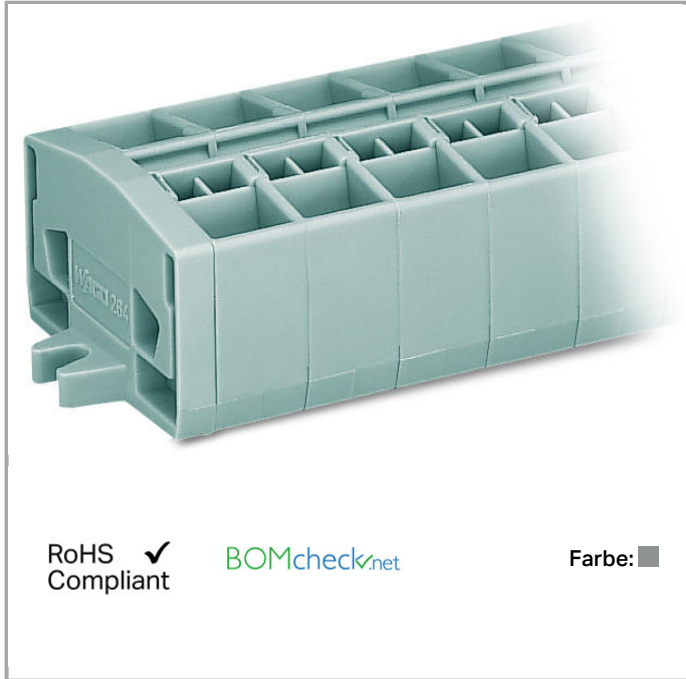

RoHS Compliant

BOMcheck.net

Farbe: ■

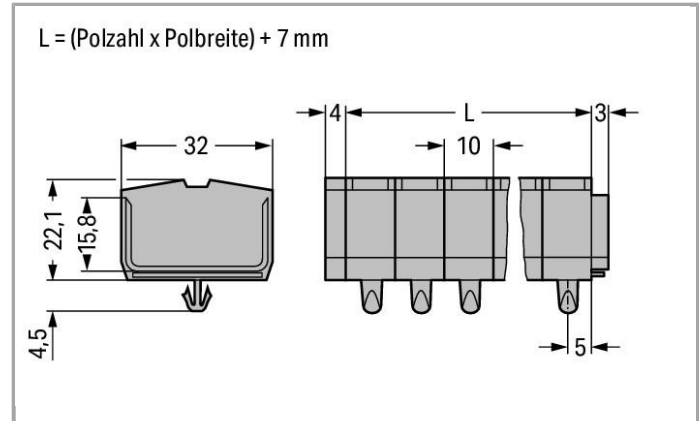

Daten

Elektrische Daten

Bemessungsdaten gemäß IEC/EN 60664-1

Bemessungsspannung (III / 3)	800 V
Bemessungsstoßspannung (III / 3)	8 kV
Bemessungsstrom	24 A
Legende Bemessungsdaten	(III / 3) ≙ Überspannungskategorie III / Verschmutzungsgrad 3

Anschlusdaten

Anschlusstechnik	CAGE CLAMP®
Betätigungsart	Betätigungswerkzeug
Anschließbare Leiterwerkstoffe	Kupfer Aluminium
Eindrähtiger Leiter	0,08 ... 2,5 mm ² / 28 ... 12 AWG
Feindrähtiger Leiter	0,08 ... 2,5 mm ² / 28 ... 12 AWG
Abisolierlänge	8 ... 9 mm / 0.31 ... 0.35 inch
Polzahl	2
Gesamte Anzahl der Klemmstellen	8



Gesamte Anzahl der Potentiale	2
Anzahl der Ebenen	1
Verdrahtungsart	Frontverdrahtung

Geometrische Daten

Breite	27 mm / 1.063 inch
Höhe ab Oberfläche	22,1 mm / 0.87 inch
Tiefe	32 mm / 1.26 inch

Mechanische Daten

Bauform	horizontale Bauform
Befestigungsart	Rastfuß
Beschriftungsebene	Mittenbeschriftung

Werkstoffdaten

Farbe	grau
Brandlast	0.284 MJ
Gewicht	14.74 g

Kaufmännische Daten

Ursprungsland	DE
GTIN	4044918416009
Zolltarifnummer	85369010000
Produktgruppe	9 (Mini-Klemmen)
eCl@ss 9.0	27-14-11-06
eCl@ss 8.0	27-14-11-06
ETIM 6.0	EC001284
ETIM 5.0	EC001284

Zulassungen / Zertifikate

Länderspezifische Zulassungen

Logo	Zulassung	Zertifikatsname
	CB DEKRA Certification B.V.	NL-49768
	CCA DEKRA Certification B.V.	NTR NL-7342
	CCA DEKRA Certification B.V.	NTR NL-7342

	CCA DEKRA Certification B.V.	2175624.01
--	--	------------

	CSA DEKRA Certification B.V.	70010891
--	--	----------

Schiff Zulassungen

Logo	Zulassung	Zertifikatsname
	ABS American Bureau of Shipping	14-HG1241539-PDA

	DNV GL Det Norske Veritas, Germanischer Lloyd	TAE00001V2
--	---	------------

	LR Lloyds Register	91/20242 (E7)
---	------------------------------	---------------

UL-Zulassungen

Logo	Zulassung	Zertifikatsname
	UR Underwriters Laboratories Inc.	E45172, sec. 6

Passende Produkte

Montage

	Art-Nr.: 709-153 Abdeckprofil; Typ 1; passend zu Abdeckprofilträger Typ 1; 1 m lang	www.wago.com/709-153
--	---	--

Allgemeines Zubehör

	Art-Nr.: 209-122 Kunststoffendklammer; mit WSB beschriftbar; für Alu-Schiene 210-154	www.wago.com/209-122
--	--	--

Prüfen und Messen

	Art-Nr.: 210-136 Prüfstecker; Ø 2 mm; mit 500mm-Leitung	www.wago.com/210-136
--	---	--

	Art-Nr.: 210-137 Prüfstecker; Ø 2,3 mm; mit 500mm-Leitung	www.wago.com/210-137
--	---	--



Art-Nr.: 249-139
 Prüfsteckermodul; ohne Rastklinken; anreihbar; für 4-Leiter-Klemmen

www.wago.com/249-139

Werkzeug



Art-Nr.: 209-130
 Betätigungswerkzeug; passend zu Serie 264, 280, 281; 1-fach; aus Isolierstoff

www.wago.com/209-130



Art-Nr.: 210-657
 Betätigungswerkzeug mit teilisoliertem Schaft; Klinge (3,5 x 0,5) mm; kurz

www.wago.com/210-657



Art-Nr.: 210-658
 Betätigungswerkzeug mit teilisoliertem Schaft; Klinge (3,5 x 0,5) mm; kurz; abgewinkelt

www.wago.com/210-658



Art-Nr.: 210-720
 Betätigungswerkzeug mit teilisoliertem Schaft; Typ 2, Klinge (3,5 x 0,5) mm

www.wago.com/210-720



Art-Nr.: 280-432
 Betätigungswerkzeug; aus Isolierstoff; 2-fach

www.wago.com/280-432

Aderendhülse



Art-Nr.: 216-101
 Aderendhülse; Hülse für 0,5 mm² / AWG 22; ohne Kunststoffkragen; galvanisch verzinkt

www.wago.com/216-101



Art-Nr.: 216-102
 Aderendhülse; Hülse für 0,75 mm² / AWG 20; ohne Kunststoffkragen; galvanisch verzinkt

www.wago.com/216-102



Art-Nr.: 216-103
 Aderendhülse; Hülse für 1 mm² / AWG 18; ohne Kunststoffkragen; galvanisch verzinkt

www.wago.com/216-103



Art-Nr.: 216-104
 Aderendhülse; Hülse für 1,5 mm² / AWG 16; ohne Kunststoffkragen; galvanisch verzinkt

www.wago.com/216-104



Art-Nr.: 216-106
 Aderendhülse; Hülse für 2,5 mm² / AWG 14; ohne Kunststoffkragen; galvanisch verzinkt

www.wago.com/216-106



Art-Nr.: 216-121
 Aderendhülse; Hülse für 0,5 mm² / AWG 22; ohne Kunststoffkragen; galvanisch verzinkt

www.wago.com/216-121



Art-Nr.: 216-122
 Aderendhülse; Hülse für 0,75 mm² / AWG 20; ohne Kunststoffkragen; galvanisch verzinkt

www.wago.com/216-122



Art-Nr.: 216-123
 Aderendhülse; Hülse für 1 mm² / AWG 18; ohne Kunststoffkragen; galvanisch verzinkt

www.wago.com/216-123



Art-Nr.: 216-124
 Aderendhülse; Hülse für 1,5 mm² / AWG 16; ohne Kunststoffkragen; galvanisch verzinkt

www.wago.com/216-124



Art-Nr.: 216-131
 Aderendhülse; Hülse für 0,25 mm² / AWG 24; ohne Kunststoffkragen; galvanisch verzinkt

www.wago.com/216-131















Art-Nr.: 216-132
 Aderendhülse; Hülse für 0,34 mm² / AWG 24; ohne Kunststoffkragen; galvanisch verzinkt

www.wago.com/216-132





Art-Nr.: 216-151
 Aderendhülse; Hülse für 0,25 mm² / AWG 24; ohne Kunststoffkragen; galvanisch verzinkt

www.wago.com/216-151

	Art-Nr.: 216-152 Aderendhülse; Hülse für 0,34 mm ² / AWG 24; ohne Kunststoffkragen; galvanisch verzinkt	www.wago.com/216-152
	Art-Nr.: 216-201 Aderendhülse; Hülse für 0,5 mm ² / AWG 22; mit Kunststoffkragen; galvanisch verzinkt	www.wago.com/216-201
	Art-Nr.: 216-202 Aderendhülse; Hülse für 0,75 mm ² / AWG 20; mit Kunststoffkragen; galvanisch verzinkt	www.wago.com/216-202
	Art-Nr.: 216-203 Aderendhülse; Hülse für 1 mm ² / AWG 18; mit Kunststoffkragen; galvanisch verzinkt	www.wago.com/216-203
	Art-Nr.: 216-204 Aderendhülse; Hülse für 1,5 mm ² / AWG 16; mit Kunststoffkragen; galvanisch verzinkt	www.wago.com/216-204
	Art-Nr.: 216-205 Aderendhülse; Hülse für 2,08 mm ² / AWG 14; mit Kunststoffkragen; galvanisch verzinkt	www.wago.com/216-205
	Art-Nr.: 216-206 Aderendhülse; Hülse für 2,5 mm ² / AWG 14; mit Kunststoffkragen; galvanisch verzinkt	www.wago.com/216-206
	Art-Nr.: 216-221 Aderendhülse; Hülse für 0,5 mm ² / AWG 22; mit Kunststoffkragen; galvanisch verzinkt	www.wago.com/216-221
	Art-Nr.: 216-222 Aderendhülse; Hülse für 0,75 mm ² / AWG 20; mit Kunststoffkragen; galvanisch verzinkt	www.wago.com/216-222
	Art-Nr.: 216-223 Aderendhülse; Hülse für 1 mm ² / AWG 18; mit Kunststoffkragen; galvanisch verzinkt	www.wago.com/216-223
	Art-Nr.: 216-224 Aderendhülse; Hülse für 1,5 mm ² / AWG 16; mit Kunststoffkragen; galvanisch verzinkt	www.wago.com/216-224
	Art-Nr.: 216-321 Aderendhülse; Hülse für 0,25 mm ² / AWG 24; mit Kunststoffkragen; galvanisch verzinkt	www.wago.com/216-321
	Art-Nr.: 216-322 Aderendhülse; Hülse für 0,34 mm ² / AWG 24; mit Kunststoffkragen; galvanisch verzinkt	www.wago.com/216-322

Brücker















	Art-Nr.: 264-402 Einlegebrücke; isoliert; 2-fach; reduziert anschließbaren Querschnitt auf 1,5 mm	www.wago.com/264-402
	Art-Nr.: 280-492 Doppelteilungsbrückungskamm; isoliert; 2-fach; IN = IN Klemme	www.wago.com/280-492

Tragschiene

	Art-Nr.: 210-154 Aluminiumtragschiene; 1000 mm lang; 18 mm breit; 7 mm hoch	www.wago.com/210-154
--	---	--

Beschriftungsmaterial

	Art-Nr.: 2009-145 Mini-WSB Inline; für smartPRINTER; auf Rolle; dehnbar 5 - 5,2 mm; unbedruckt; aufrastbar	www.wago.com/2009-145
--	--	--

	Art-Nr.: 2009-145/000-002 Mini-WSB Inline; für smartPRINTER; auf Rolle; dehnbar 5 - 5,2 mm; unbedruckt; aufrastbar	www.wago.com/2009-145/000-002
	Art-Nr.: 2009-145/000-005 Mini-WSB Inline; für smartPRINTER; auf Rolle; dehnbar 5 - 5,2 mm; unbedruckt; aufrastbar	www.wago.com/2009-145/000-005
	Art-Nr.: 2009-145/000-006 Mini-WSB Inline; für smartPRINTER; auf Rolle; dehnbar 5 - 5,2 mm; unbedruckt; aufrastbar	www.wago.com/2009-145/000-006
	Art-Nr.: 2009-145/000-007 Mini-WSB Inline; für smartPRINTER; auf Rolle; dehnbar 5 - 5,2 mm; unbedruckt; aufrastbar	www.wago.com/2009-145/000-007
	Art-Nr.: 2009-145/000-012 Mini-WSB Inline; für smartPRINTER; auf Rolle; dehnbar 5 - 5,2 mm; unbedruckt; aufrastbar	www.wago.com/2009-145/000-012
	Art-Nr.: 2009-145/000-023 Mini-WSB Inline; für smartPRINTER; auf Rolle; dehnbar 5 - 5,2 mm; unbedruckt; aufrastbar	www.wago.com/2009-145/000-023
	Art-Nr.: 2009-145/000-024 Mini-WSB Inline; auf Rolle; dehnbar 5 - 5,2 mm; unbedruckt; aufrastbar	www.wago.com/2009-145/000-024
	Art-Nr.: 209-290 Beschriftungsstrang; nicht dehnbar; unbedruckt; aufrastbar	www.wago.com/209-290
	Art-Nr.: 248-501 Mini-WSB-Schnellbeschriftungssystem; unbedruckt; Schildchenbreite 5 mm; 10 Streifen à 10 Schilder pro Karte	www.wago.com/248-501
	Art-Nr.: 248-501/000-002 Mini-WSB-Beschriftungskarte; als Karte; nicht dehnbar; unbedruckt; aufrastbar	www.wago.com/248-501/000-002
	Art-Nr.: 248-501/000-005 Mini-WSB-Beschriftungskarte; als Karte; unbedruckt; aufrastbar	www.wago.com/248-501/000-005
	Art-Nr.: 248-501/000-006 Mini-WSB-Beschriftungskarte; als Karte; nicht dehnbar; unbedruckt; aufrastbar	www.wago.com/248-501/000-006
	Art-Nr.: 248-501/000-007 Mini-WSB-Beschriftungskarte; als Karte; nicht dehnbar; unbedruckt; aufrastbar	www.wago.com/248-501/000-007
	Art-Nr.: 248-501/000-012 Mini-WSB-Beschriftungskarte; als Karte; nicht dehnbar; unbedruckt; aufrastbar	www.wago.com/248-501/000-012
	Art-Nr.: 248-501/000-017 Mini-WSB-Beschriftungskarte; als Karte; nicht dehnbar; unbedruckt; aufrastbar	www.wago.com/248-501/000-017



Art-Nr.: 248-501/000-023

Mini-WSB-Beschriftungskarte; als Karte; nicht dehnbar; unbedruckt; aufrastbar

www.wago.com/248-501/000-023



Art-Nr.: 248-501/000-024

Mini-WSB-Beschriftungskarte; als Karte; nicht dehnbar; unbedruckt; aufrastbar

www.wago.com/248-501/000-024

Downloads

Dokumentation

Ausschreibungstext

264-252	Oct 11, 2017	DOC 25,6 kB	Download
---------	--------------	----------------	----------

smartDATA

CAD Daten

3D Download 264-252	URL	Download
---------------------	-----	----------

Änderungen vorbehalten.

WAGO Kontakttechnik GmbH & Co. KG
Hansastr. 27
32423 Minden
Telefon: +49571 887-0
E-Mail: info.de@wago.com | Web: www.wago.com

Haben Sie Fragen zu unseren Produkten?
Wir stehen Ihnen telefonisch unter +49 (571) 887-44222 gern zur Verfügung.