

Datenblatt | Artikelnummer: 279-831

4-Leiter-Durchgangsklemme; 1,5 mm²; mittige Beschriftung; für Tragschiene 35 x 15 und 35 x 7,5; CAGE CLAMP®

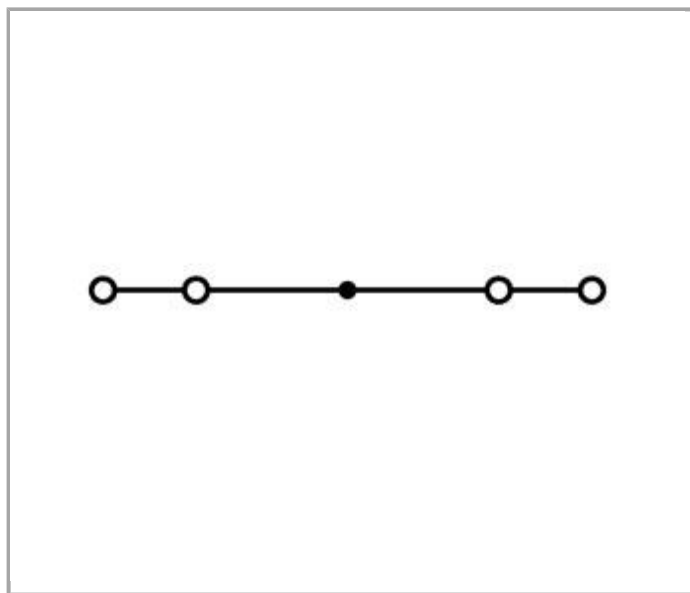

www.wago.com/279-831

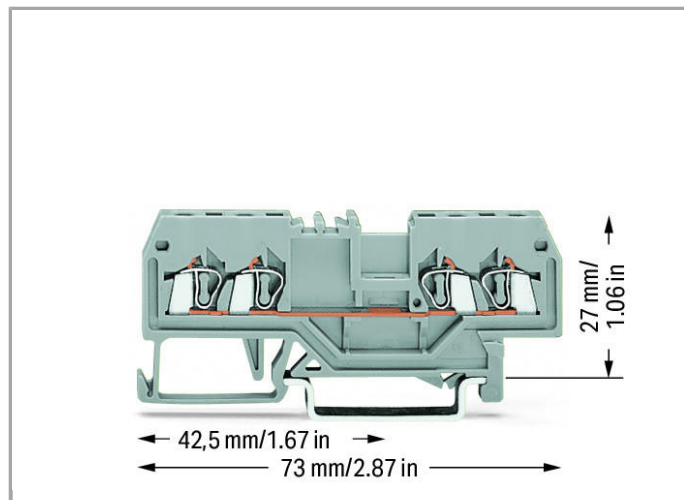
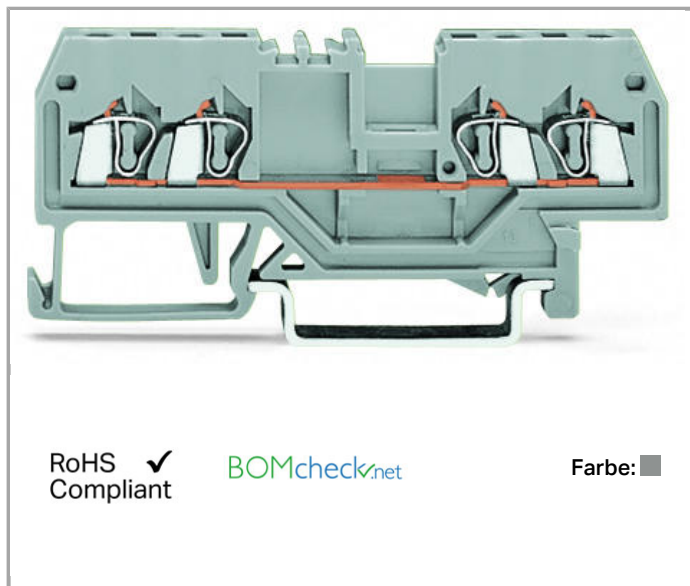

Daten

Elektrische Daten

Bemessungsdaten gemäß IEC/EN 60664-1

Bemessungsspannung (III / 3)	800 V
Bemessungsstoßspannung (III / 3)	8 kV
Bemessungsstrom	18 A

Legende Bemessungsdaten

(III / 3) \triangleq Überspannungskategorie III / Verschmutzungsgrad 3

Anschlussdaten

Anschluss technik	CAGE CLAMP®
Betätigungsart	Betätigungswerkzeug
Anschließbare Leiterwerkstoffe	Kupfer Aluminium
Eindrähtiger Leiter	0,08 ... 1,5 mm ² / 28 ... 16 AWG
Feindrähtiger Leiter	0,08 ... 1,5 mm ² / 28 ... 16 AWG
Abisolierlänge	8 ... 9 mm / 0.31 ... 0.35 inch
Gesamte Anzahl der Klemmstellen	4
Gesamte Anzahl der Potentiale	1
Anzahl der Ebenen	1
Verdrahtungsart	Frontverdrahtung

Geometrische Daten

Breite	4 mm / 0.157 inch
Höhe ab Oberkante Tragschiene	27 mm / 1.063 inch
Tiefe	73 mm / 2.874 inch

Mechanische Daten

Bauform	horizontale Bauform
Montageart	Tragschiene 35
Beschriftungsebene	Mittenbeschriftung

Werkstoffdaten



Farbe	grau
Isolierwerkstoff	Polyamid 66 (PA 66)
Brandlast	0.116 MJ
Gewicht	6.31 g

Kaufmännische Daten



Ursprungsland	DE
GTIN	4044918520423
Zolltarifnummer	85369010000
Produktgruppe	1 (Reihenklemmen)
eCl@ss 9.0	27-14-11-20
eCl@ss 8.0	27-14-11-20
ETIM 6.0	EC000897
ETIM 5.0	EC000897

Zulassungen / Zertifikate

Länderspezifische Zulassungen

Logo	Zulassung	Zertifikatsname
	CCA DEKRA Certification B.V.	NTR NL-7081
	KEMA/KEUR DEKRA Certification B.V.	2160584.04

Schiff Zulassungen



Logo	Zulassung	Zertifikatsname
	ABS American Bureau of Shipping	14-HG1293677-PDA
	BV Bureau Veritas S.A.	07436/E0 BV
	LR Lloyds Register	91/20112 (E9)

UL-Zulassungen

Logo	Zulassung	Zertifikatsname
	UR Underwriters Laboratories Inc.	E45172

Passende Produkte

Brücker

	Art-Nr.: 210-103 Drahtkettenbrücke; isoliert; 50 Anschlüsse	www.wago.com/210-103
	Art-Nr.: 249-123 Steckbarer Leitungsbrücker; isoliert; L = 180 mm; Leitungsquerschnitt 0,75 mm ²	www.wago.com/249-123
	Art-Nr.: 249-125 Steckbarer Leitungsbrücker; isoliert; L = 60 mm; Leitungsquerschnitt 0,75 mm ²	www.wago.com/249-125



Art-Nr.: 249-126
Steckbarer Leitungsbrücker; isoliert; L = 110 mm; Leitungsquerschnitt 0,75 mm²

www.wago.com/249-126



Art-Nr.: 249-127
Steckbarer Leitungsbrücker; isoliert; L = 250 mm; Leitungsquerschnitt 0,75 mm²

www.wago.com/249-127



Art-Nr.: 279-402
Querbrücker; isoliert; Nennstrom 15 A

www.wago.com/279-402



Art-Nr.: 279-409
Doppelteilungsquerbrücker; isoliert; Nennstrom 15 A

www.wago.com/279-409



Art-Nr.: 279-422
Querbrücker; isoliert; Nennstrom 15 A

www.wago.com/279-422



Art-Nr.: 279-482
Brückungskamm; isoliert; 2-fach; IN = IN Klemme

www.wago.com/279-482



Art-Nr.: 279-483
Brückungskamm; isoliert; 3-fach; IN = IN Klemme

www.wago.com/279-483



Art-Nr.: 279-490
Brückungskamm; isoliert; 10-fach; IN = IN Klemme

www.wago.com/279-490



Art-Nr.: 279-492
Doppelteilungsbrückungskamm; isoliert; 2-fach; IN = IN Klemme

www.wago.com/279-492



Art-Nr.: 284-414
Reduzierbrücker; isoliert; von 10/6 mm² auf 4/2,5/1,5 mm²; Nennstrom 15 A

www.wago.com/284-414

Werkzeug



Art-Nr.: 210-647
Betätigungswerkzeug mit teilisoliertem Schaft; Klinge (2,5 x 0,4) mm; kurz

www.wago.com/210-647



Art-Nr.: 210-648
Betätigungswerkzeug mit teilisoliertem Schaft; Klinge (2,5 x 0,4) mm; kurz; abgewinkelt

www.wago.com/210-648



Art-Nr.: 210-719
Betätigungswerkzeug mit teilisoliertem Schaft; Typ 1, Klinge (2,5 x 0,4) mm

www.wago.com/210-719

Prüfen und Messen



Art-Nr.: 209-170
Prüfadapter; 8,3 mm breit; für Prüfstecker Ø 4 mm; passend für Klemmen 1,5 mm² - 10 mm²

www.wago.com/209-170

Allgemeines Zubehör



Art-Nr.: 249-105
Gruppenschildträger

www.wago.com/249-105



Art-Nr.: 280-404
Prüfadapter; 5 mm breit; für Prüfstecker 210-137 (Ø 2,3 mm); passend für Klemmen 1,5 mm² - 4 mm²



















www.wago.com/280-404

Aderendhülse



Art-Nr.: 216-101
Aderendhülse; Hülse für 0,5 mm² / AWG 22; ohne Kunststoffkragen; galvanisch verzinkt



www.wago.com/216-101

	Art-Nr.: 216-102 Aderendhülse; Hülse für 0,75 mm ² / AWG 20; ohne Kunststoffkragen; galvanisch verzinkt	www.wago.com/216-102
	Art-Nr.: 216-103 Aderendhülse; Hülse für 1 mm ² / AWG 18; ohne Kunststoffkragen; galvanisch verzinkt	www.wago.com/216-103
	Art-Nr.: 216-201 Aderendhülse; Hülse für 0,5 mm ² / AWG 22; mit Kunststoffkragen; galvanisch verzinkt	www.wago.com/216-201
	Art-Nr.: 216-202 Aderendhülse; Hülse für 0,75 mm ² / AWG 20; mit Kunststoffkragen; galvanisch verzinkt	www.wago.com/216-202
	Art-Nr.: 216-203 Aderendhülse; Hülse für 1 mm ² / AWG 18; mit Kunststoffkragen; galvanisch verzinkt	www.wago.com/216-203
	Art-Nr.: 216-301 Aderendhülse; Hülse für 0,25 mm ² / AWG 24; mit Kunststoffkragen; galvanisch verzinkt	www.wago.com/216-301
	Art-Nr.: 216-302 Aderendhülse; Hülse für 0,34 mm ² / AWG 24; mit Kunststoffkragen; galvanisch verzinkt	www.wago.com/216-302
Tragschiene		
	Art-Nr.: 210-112 Stahltragschiene; 35 x 7,5 mm; 1 mm dick; 2 m lang; gelocht; entsprechend EN 60715; Lochbreite 25 mm; Lochabstand 36 mm	www.wago.com/210-112
	Art-Nr.: 210-113 Stahltragschiene; 35 x 7,5 mm; 1 mm dick; 2 m lang; ungelocht; entsprechend EN 60715	www.wago.com/210-113
	Art-Nr.: 210-114 Stahltragschiene; 35 x 15 mm; 1,5 mm dick; 2 m lang; ungelocht; ähnlich EN 60715	www.wago.com/210-114
	Art-Nr.: 210-115 Stahltragschiene; 35 x 7,5 mm; 1 mm dick; 2 m lang; gelocht; entsprechend EN 60715; Lochbreite 18 mm; Lochabstand 25 mm	www.wago.com/210-115
	Art-Nr.: 210-118 Stahltragschiene; 35 x 15 mm; 2,3 mm dick; 2 m lang; ungelocht; entsprechend EN 60715	www.wago.com/210-118
	Art-Nr.: 210-196 Aluminiumtragschiene; 35 x 8,2 mm; 1,6 mm dick; 2 m lang; ungelocht; ähnlich EN 60715	www.wago.com/210-196
	Art-Nr.: 210-197 Stahltragschiene; 35 x 15 mm; 1,5 mm dick; 2 m lang; gelocht; ähnlich EN 60715	www.wago.com/210-197
	Art-Nr.: 210-198 Kupfertragschiene; 35 x 15 mm; 2,3 mm dick; 2 m lang; ungelocht; entsprechend EN 60715	www.wago.com/210-198
	Art-Nr.: 210-504 Stahltragschiene; 35 x 7,5 mm; 1 mm dick; 2 m lang; gelocht; bandverzinkt; entsprechend EN 60715	www.wago.com/210-504
	Art-Nr.: 210-505 Stahltragschiene; 35 x 7,5 mm; 1 mm dick; 2 m lang; ungelocht; bandverzinkt; entsprechend EN 60715	www.wago.com/210-505
	Art-Nr.: 210-506 Stahltragschiene; 35 x 15 mm; 1,5 mm dick; 2 m lang; ungelocht; bandverzinkt; ähnlich EN 60715	www.wago.com/210-506
	Art-Nr.: 210-508 Stahltragschiene; 35 x 15 mm; 1,5 mm dick; 2 m lang; gelocht; bandverzinkt; ähnlich EN 60715	www.wago.com/210-508

Abschlussplatte

	Art-Nr.: 279-344 Abschluss- und Zwischenplatte; 2 mm dick	www.wago.com/279-344
	Art-Nr.: 279-345 Trennwand; 2 mm dick; überstehend	www.wago.com/279-345
	Art-Nr.: 279-346 Abschluss- und Zwischenplatte; 2 mm dick	www.wago.com/279-346
	Art-Nr.: 279-347 Trennwand; 2 mm dick; überstehend	www.wago.com/279-347
	Art-Nr.: 284-334 Reduzierabdeckplatte; 1 mm dick; in Verbindung mit 2-, 3- und 4-Leiter-Klemmen	www.wago.com/284-334
	Art-Nr.: 284-336 Reduzierabdeckplatte; 1 mm dick; in Verbindung mit 4-Leiter-Klemmen 279-831, 280-833 und 281-652	www.wago.com/284-336
	Art-Nr.: 284-344 Reduzierabdeckplatte; 1 mm dick; in Verbindung mit 2-, 3- und 4-Leiter-Klemmen	www.wago.com/284-344
	Art-Nr.: 284-346 Reduzierabdeckplatte; 1 mm dick; in Verbindung mit 4-Leiter-Klemmen 279-831, 280-833 und 281-652	www.wago.com/284-346





Montage

















	Art-Nr.: 209-106 Haltebock; zur isolierten Montage von Tragschienen DIN 35	www.wago.com/209-106
	Art-Nr.: 709-153 Abdeckprofil; Typ 1; passend zu Abdeckprofilträger Typ 1; 1 m lang	www.wago.com/709-153

Warnabdeckung

	Art-Nr.: 279-415 Warnabdeckung; mit schwarzem Blitzpfeil; für 5 Klemmen	www.wago.com/279-415
--	---	--

Beschriftungsmaterial

	Art-Nr.: 2009-114 WMB-Inline; für smartPRINTER; auf Rolle; dehnbar 4 - 4,2 mm; unbedruckt; aufrastbar	www.wago.com/2009-114
	Art-Nr.: 2009-114/000-002 WMB-Inline; für smartPRINTER; auf Rolle; dehnbar 4 - 4,2 mm; unbedruckt; aufrastbar	www.wago.com/2009-114/000-002
	Art-Nr.: 2009-114/000-005 WMB-Inline; für smartPRINTER; auf Rolle; dehnbar 4 - 4,2 mm; unbedruckt; aufrastbar	www.wago.com/2009-114/000-005
	Art-Nr.: 2009-114/000-006 WMB-Inline; für smartPRINTER; auf Rolle; dehnbar 4 - 4,2 mm; unbedruckt; aufrastbar	www.wago.com/2009-114/000-006

	<p>Art-Nr.: 2009-114/000-007 WMB-Inline; für smartPRINTER; auf Rolle; dehnbar 4 - 4,2 mm; unbedruckt; aufrastbar</p>	www.wago.com/2009-114/000-007
	<p>Art-Nr.: 2009-114/000-012 WMB-Inline; für smartPRINTER; auf Rolle; dehnbar 4 - 4,2 mm; unbedruckt; aufrastbar</p>	www.wago.com/2009-114/000-012
	<p>Art-Nr.: 2009-114/000-023 WMB-Inline; für smartPRINTER; auf Rolle; dehnbar 4 - 4,2 mm; unbedruckt; aufrastbar</p>	www.wago.com/2009-114/000-023
	<p>Art-Nr.: 2009-114/000-024 WMB-Inline; für smartPRINTER; auf Rolle; dehnbar 4 - 4,2 mm; unbedruckt; aufrastbar</p>	www.wago.com/2009-114/000-024
	<p>Art-Nr.: 209-128 Adapter</p>	www.wago.com/209-128
	<p>Art-Nr.: 209-140 Gruppenschildträger</p>	www.wago.com/209-140
	<p>Art-Nr.: 209-141 Gruppenschildträger</p>	www.wago.com/209-141
	<p>Art-Nr.: 209-142 Gruppenschildträger</p>	www.wago.com/209-142
	<p>Art-Nr.: 209-185 Adapter</p>	www.wago.com/209-185
	<p>Art-Nr.: 793-4501 WMB-Beschriftungskarte; als Karte; dehnbar 4 - 4,2 mm; unbedruckt; aufrastbar</p>	www.wago.com/793-4501
	<p>Art-Nr.: 793-4501/000-002 WMB-Beschriftungskarte; als Karte; dehnbar 4 - 4,2 mm; unbedruckt; aufrastbar</p>	www.wago.com/793-4501/000-002
	<p>Art-Nr.: 793-4501/000-005 WMB-Beschriftungskarte; als Karte; dehnbar 4 - 4,2 mm; unbedruckt; aufrastbar</p>	www.wago.com/793-4501/000-005
	<p>Art-Nr.: 793-4501/000-006 WMB-Beschriftungskarte; als Karte; dehnbar 4 - 4,2 mm; unbedruckt; aufrastbar</p>	www.wago.com/793-4501/000-006
	<p>Art-Nr.: 793-4501/000-007 WMB-Beschriftungskarte; als Karte; dehnbar 4 - 4,2 mm; unbedruckt; aufrastbar</p>	www.wago.com/793-4501/000-007
	<p>Art-Nr.: 793-4501/000-012 WMB-Beschriftungskarte; als Karte; dehnbar 4 - 4,2 mm; unbedruckt; aufrastbar</p>	www.wago.com/793-4501/000-012
	<p>Art-Nr.: 793-4501/000-017 WMB-Beschriftungskarte; als Karte; dehnbar 4 - 4,2 mm; unbedruckt; aufrastbar</p>	www.wago.com/793-4501/000-017



Art-Nr.: 793-4501/000-023

WMB-Beschriftungskarte; als Karte; dehnbar 4 - 4,2 mm; unbedruckt; aufrastbar

www.wago.com/793-4501/000-023



Art-Nr.: 793-4501/000-024

WMB-Beschriftungskarte; als Karte; dehnbar 4 - 4,2 mm; unbedruckt; aufrastbar

www.wago.com/793-4501/000-024

Isolierungs-Stopp



Art-Nr.: 279-470

Isolierungsstopp; 0,08 - 0,2 mm² "e" (0,14 mm² "f"); 5 Stück / Strang

www.wago.com/279-470



Art-Nr.: 279-471

Isolierungsstopp; 0,25 mm²; 5 Stück / Strang

www.wago.com/279-471

Downloads

Dokumentation

Ausschreibungstext

279-831	Oct 12, 2017	DOC 24,1 kB	Download
---------	--------------	----------------	----------

smartDATA

CAD Daten

3D Download 279-831	URL	Download
---------------------	-----	----------

Änderungen vorbehalten.