

Datenblatt | Artikelnummer: 279-989

Doppeldurchgangsklemme; 1,5 mm²; für Anwendungen Ex e II geeignet;
seitliche Beschriftungsaufnahmen; für Tragschiene 35 x 15 und 35 x 7,5;
CAGE CLAMP®

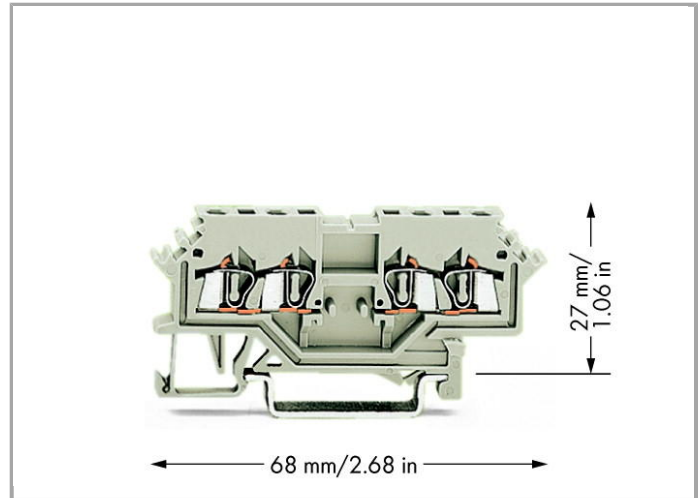

www.wago.com/279-989

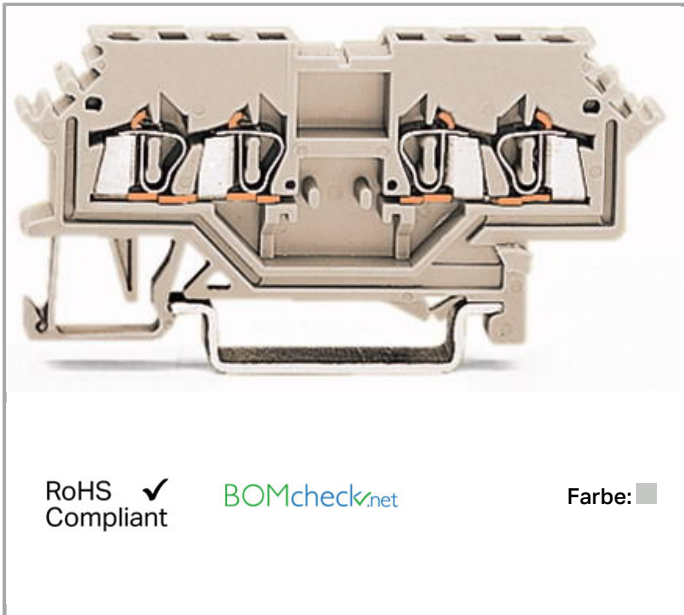

RoHS Compliant

[BOMcheck.net](https://www.bomcheck.net)

Farbe:

Daten

Elektrische Daten

Bemessungsspannung EN (Ex e II) 550 V

Bemessungsdaten gemäß IEC/EN 60664-1

Bemessungsstrom 15 A

Anschlussdaten

Anschluss technik	CAGE CLAMP®
Betätigungsart	Betätigungswerkzeug
Anschließbare Leiterwerkstoffe	Kupfer Aluminium
Eindrähtiger Leiter	0,08 ... 1,5 mm ² / 28 ... 16 AWG
Feindrähtiger Leiter	0,08 ... 1,5 mm ² / 28 ... 16 AWG
Abisolierlänge	8 ... 9 mm / 0.31 ... 0.35 inch
Gesamte Anzahl der Klemmstellen	4
Gesamte Anzahl der Potentiale	2
Anzahl der Ebenen	1
Verdrahtungsart	Frontverdrahtung

Geometrische Daten

Breite	4 mm / 0.157 inch
Höhe ab Oberkante Tragschiene	27 mm / 1.063 inch
Tiefe	68 mm / 2.677 inch

Mechanische Daten

Bauform	horizontale Bauform
Montageart	Tragschiene 35
Beschriftungsebene	Seitliche Beschriftung

Werkstoffdaten

Farbe	lichtgrau
Isolierwerkstoff	Polyamid 66 (PA 66)
Brandlast	0.103 MJ
Gewicht	5.556 g

Kaufmännische Daten

Ursprungsland	DE
GTIN	4044918506540
Zolltarifnummer	85369010000
Produktgruppe	1 (Reihenklempen)
eCl@ss 9.0	27-14-11-20
eCl@ss 8.0	27-14-11-20
ETIM 6.0	EC000897
ETIM 5.0	EC000897

Zulassungen / Zertifikate

Ex-Zulassungen



Logo	Zulassung	Zertifikatsname
	AEx UL International Germany GmbH c/o Physikalisch Technische Bundesanstalt	E185892 Sec.15

Länderspezifische Zulassungen

Logo	Zulassung	Zertifikatsname
	CCA DEKRA Certification B.V.	NTR NL-7081
	KEMA/KEUR DEKRA Certification B.V.	2160584.04



Schiff Zulassungen



Logo	Zulassung	Zertifikatsname
	ABS American Bureau of Shipping	14-HG1293677-PDA
	LR Lloyds Register	91/20112 (E9)

UL-Zulassungen





Logo	Zulassung	Zertifikatsname
	UR Underwriters Laboratories Inc.	E45172















Passende Produkte

Isolierungs-Stopp

	Art-Nr.: 279-470 Isolierungsstopp; 0,08 - 0,2 mm ² "e" (0,14 mm ² "f"); 5 Stück / Strang	www.wago.com/279-470
	Art-Nr.: 279-471 Isolierungsstopp; 0,25 mm ² ; 5 Stück / Strang	www.wago.com/279-471

Tragschiene

	Art-Nr.: 210-112 Stahltragschiene; 35 x 7,5 mm; 1 mm dick; 2 m lang; gelocht; entsprechend EN 60715; Lochbreite 25 mm; Lochabstand 36 mm	www.wago.com/210-112
	Art-Nr.: 210-113 Stahltragschiene; 35 x 7,5 mm; 1 mm dick; 2 m lang; ungelocht; entsprechend EN 60715	www.wago.com/210-113
	Art-Nr.: 210-114 Stahltragschiene; 35 x 15 mm; 1,5 mm dick; 2 m lang; ungelocht; ähnlich EN 60715	www.wago.com/210-114
	Art-Nr.: 210-115 Stahltragschiene; 35 x 7,5 mm; 1 mm dick; 2 m lang; gelocht; entsprechend EN 60715; Lochbreite 18 mm; Lochabstand 25 mm	www.wago.com/210-115
	Art-Nr.: 210-118 Stahltragschiene; 35 x 15 mm; 2,3 mm dick; 2 m lang; ungelocht; entsprechend EN 60715	www.wago.com/210-118
	Art-Nr.: 210-196 Aluminiumtragschiene; 35 x 8,2 mm; 1,6 mm dick; 2 m lang; ungelocht; ähnlich EN 60715	www.wago.com/210-196

	Art-Nr.: 210-197 Stahltragschiene; 35 x 15 mm; 1,5 mm dick; 2 m lang; gelocht; ähnlich EN 60715	www.wago.com/210-197
	Art-Nr.: 210-198 Kupfertragschiene; 35 x 15 mm; 2,3 mm dick; 2 m lang; ungelocht; entsprechend EN 60715	www.wago.com/210-198
	Art-Nr.: 210-504 Stahltragschiene; 35 x 7,5 mm; 1 mm dick; 2 m lang; gelocht; bandverzinkt; entsprechend EN 60715	www.wago.com/210-504
	Art-Nr.: 210-505 Stahltragschiene; 35 x 7,5 mm; 1 mm dick; 2 m lang; ungelocht; bandverzinkt; entsprechend EN 60715	www.wago.com/210-505
	Art-Nr.: 210-506 Stahltragschiene; 35 x 15 mm; 1,5 mm dick; 2 m lang; ungelocht; bandverzinkt; ähnlich EN 60715	www.wago.com/210-506
	Art-Nr.: 210-508 Stahltragschiene; 35 x 15 mm; 1,5 mm dick; 2 m lang; gelocht; bandverzinkt; ähnlich EN 60715	www.wago.com/210-508
Allgemeines Zubehör		
	Art-Nr.: 249-105 Gruppenschildträger	www.wago.com/249-105
Montage		
	Art-Nr.: 209-106 Haltebock; zur isolierten Montage von Tragschienen DIN 35	www.wago.com/209-106
	Art-Nr.: 709-153 Abdeckprofil; Typ 1; passend zu Abdeckprofilträger Typ 1; 1 m lang	www.wago.com/709-153
Beschriftungsmaterial		
	Art-Nr.: 2009-114 WMB-Inline; für smartPRINTER; auf Rolle; dehnbar 4 - 4,2 mm; unbedruckt; aufrastbar	www.wago.com/2009-114
	Art-Nr.: 2009-114/000-002 WMB-Inline; für smartPRINTER; auf Rolle; dehnbar 4 - 4,2 mm; unbedruckt; aufrastbar	www.wago.com/2009-114/000-002
	Art-Nr.: 2009-114/000-005 WMB-Inline; für smartPRINTER; auf Rolle; dehnbar 4 - 4,2 mm; unbedruckt; aufrastbar	www.wago.com/2009-114/000-005
	Art-Nr.: 2009-114/000-006 WMB-Inline; für smartPRINTER; auf Rolle; dehnbar 4 - 4,2 mm; unbedruckt; aufrastbar	www.wago.com/2009-114/000-006
	Art-Nr.: 2009-114/000-007 WMB-Inline; für smartPRINTER; auf Rolle; dehnbar 4 - 4,2 mm; unbedruckt; aufrastbar	www.wago.com/2009-114/000-007
	Art-Nr.: 2009-114/000-012 WMB-Inline; für smartPRINTER; auf Rolle; dehnbar 4 - 4,2 mm; unbedruckt; aufrastbar	www.wago.com/2009-114/000-012
	Art-Nr.: 2009-114/000-023 WMB-Inline; für smartPRINTER; auf Rolle; dehnbar 4 - 4,2 mm; unbedruckt; aufrastbar	www.wago.com/2009-114/000-023



Art-Nr.: 2009-114/000-024

WMB-Inline; für smartPRINTER; auf Rolle; dehnbar 4 - 4,2 mm; unbedruckt; aufrastbar

www.wago.com/2009-114/000-024



Art-Nr.: 209-128

Adapter

www.wago.com/209-128



Art-Nr.: 209-185

Adapter

www.wago.com/209-185



Art-Nr.: 793-4501

WMB-Beschriftungskarte; als Karte; dehnbar 4 - 4,2 mm; unbedruckt; aufrastbar

www.wago.com/793-4501



Art-Nr.: 793-4501/000-002

WMB-Beschriftungskarte; als Karte; dehnbar 4 - 4,2 mm; unbedruckt; aufrastbar

www.wago.com/793-4501/000-002



Art-Nr.: 793-4501/000-005

WMB-Beschriftungskarte; als Karte; dehnbar 4 - 4,2 mm; unbedruckt; aufrastbar

www.wago.com/793-4501/000-005



Art-Nr.: 793-4501/000-006

WMB-Beschriftungskarte; als Karte; dehnbar 4 - 4,2 mm; unbedruckt; aufrastbar

www.wago.com/793-4501/000-006



Art-Nr.: 793-4501/000-007

WMB-Beschriftungskarte; als Karte; dehnbar 4 - 4,2 mm; unbedruckt; aufrastbar

www.wago.com/793-4501/000-007



Art-Nr.: 793-4501/000-012

WMB-Beschriftungskarte; als Karte; dehnbar 4 - 4,2 mm; unbedruckt; aufrastbar

www.wago.com/793-4501/000-012



Art-Nr.: 793-4501/000-017

WMB-Beschriftungskarte; als Karte; dehnbar 4 - 4,2 mm; unbedruckt; aufrastbar

www.wago.com/793-4501/000-017



Art-Nr.: 793-4501/000-023

WMB-Beschriftungskarte; als Karte; dehnbar 4 - 4,2 mm; unbedruckt; aufrastbar

www.wago.com/793-4501/000-023



Art-Nr.: 793-4501/000-024

WMB-Beschriftungskarte; als Karte; dehnbar 4 - 4,2 mm; unbedruckt; aufrastbar

www.wago.com/793-4501/000-024

Werkzeug



Art-Nr.: 210-647

Betätigungswerkzeug mit teilisoliertem Schaft; Klinge (2,5 x 0,4) mm; kurz

www.wago.com/210-647



Art-Nr.: 210-648

Betätigungswerkzeug mit teilisoliertem Schaft; Klinge (2,5 x 0,4) mm; kurz; abgewinkelt

www.wago.com/210-648





Art-Nr.: 210-719

Betätigungswerkzeug mit teilisoliertem Schaft; Typ 1, Klinge (2,5 x 0,4) mm

www.wago.com/210-719

Abschlussplatte

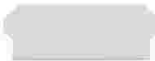
	Art-Nr.: 209-191 Trennwand Ex e/Ex i; 3 mm dick; 120 mm breit	www.wago.com/209-191
	Art-Nr.: 279-318 Abschluss- und Zwischenplatte; 2 mm dick	www.wago.com/279-318
	Art-Nr.: 279-338 Trennwand; 2 mm dick; überstehend	www.wago.com/279-338





Aderendhülse

	Art-Nr.: 216-101 Aderendhülse; Hülse für 0,5 mm ² / AWG 22; ohne Kunststoffkragen; galvanisch verzinkt	www.wago.com/216-101
	Art-Nr.: 216-102 Aderendhülse; Hülse für 0,75 mm ² / AWG 20; ohne Kunststoffkragen; galvanisch verzinkt	www.wago.com/216-102
	Art-Nr.: 216-103 Aderendhülse; Hülse für 1 mm ² / AWG 18; ohne Kunststoffkragen; galvanisch verzinkt	www.wago.com/216-103
	Art-Nr.: 216-201 Aderendhülse; Hülse für 0,5 mm ² / AWG 22; mit Kunststoffkragen; galvanisch verzinkt	www.wago.com/216-201
	Art-Nr.: 216-202 Aderendhülse; Hülse für 0,75 mm ² / AWG 20; mit Kunststoffkragen; galvanisch verzinkt	www.wago.com/216-202
	Art-Nr.: 216-203 Aderendhülse; Hülse für 1 mm ² / AWG 18; mit Kunststoffkragen; galvanisch verzinkt	www.wago.com/216-203
	Art-Nr.: 216-301 Aderendhülse; Hülse für 0,25 mm ² / AWG 24; mit Kunststoffkragen; galvanisch verzinkt	www.wago.com/216-301
	Art-Nr.: 216-302 Aderendhülse; Hülse für 0,34 mm ² / AWG 24; mit Kunststoffkragen; galvanisch verzinkt	www.wago.com/216-302

Warnabdeckung

	Art-Nr.: 279-415 Warnabdeckung; mit schwarzem Blitzpfeil; für 5 Klemmen	www.wago.com/279-415
------------------------------------------------------------------------------------	-----------------------------------------------------------------------------------	----------------------------------------------------------------

Brücker

	Art-Nr.: 210-103 Drahtkettenbrücke; isoliert; 50 Anschlüsse	www.wago.com/210-103
	Art-Nr.: 249-123 Steckbarer Leitungsbrücker; isoliert; L = 180 mm; Leitungsquerschnitt 0,75 mm ²	www.wago.com/249-123
	Art-Nr.: 249-125 Steckbarer Leitungsbrücker; isoliert; L = 60 mm; Leitungsquerschnitt 0,75 mm ²	www.wago.com/249-125
	Art-Nr.: 249-126 Steckbarer Leitungsbrücker; isoliert; L = 110 mm; Leitungsquerschnitt 0,75 mm ²	www.wago.com/249-126
	Art-Nr.: 249-127 Steckbarer Leitungsbrücker; isoliert; L = 250 mm; Leitungsquerschnitt 0,75 mm ²	www.wago.com/249-127



Art-Nr.: 279-482

Brückungskamm; isoliert; 2-fach; IN = IN Klemme

www.wago.com/279-482



Art-Nr.: 279-483

Brückungskamm; isoliert; 3-fach; IN = IN Klemme

www.wago.com/279-483



Art-Nr.: 279-490

Brückungskamm; isoliert; 10-fach; IN = IN Klemme

www.wago.com/279-490



Art-Nr.: 279-492

Doppelteilungsbrückungskamm; isoliert; 2-fach; IN = IN Klemme

www.wago.com/279-492

Downloads

smartDATA

CAD Daten

3D Download 279-989

URL

Download

Änderungen vorbehalten.

WAGO Kontakttechnik GmbH & Co. KG

Hansastr. 27

32423 Minden

Telefon: +49571 887-0

E-Mail: info.de@wago.com | Web: www.wago.com

Haben Sie Fragen zu unseren Produkten?

Wir stehen Ihnen telefonisch unter +49 (571) 887-44222 gern zur Verfügung.