

Datenblatt | Artikelnummer: 279-995

Doppeldurchgangsklemme; 1,5 mm²; für Anwendungen Ex e II geeignet; mit doppelter, mittiger Beschriftungsaufnahme; für Tragschiene 35 x 15 und 35 x 7,5; CAGE CLAMP®

www.wago.com/279-995

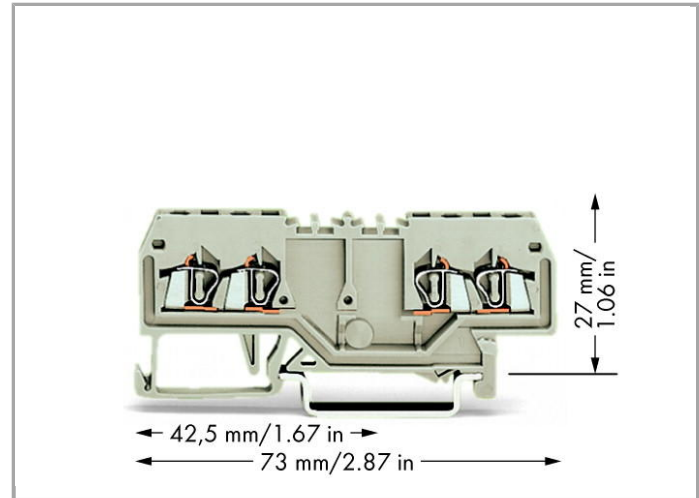
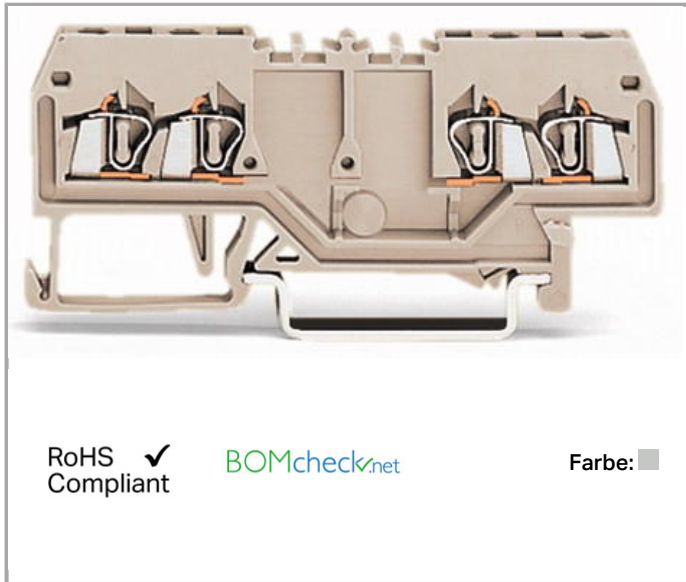

Daten

Elektrische Daten

Bemessungsspannung EN (Ex e II) 550 V

Bemessungsdaten gemäß IEC/EN 60664-1

Bemessungsstrom 15 A

Anschlussdaten

Anschluss technik	CAGE CLAMP®
Betätigungsart	Betätigungswerkzeug
Anschließbare Leiterwerkstoffe	Kupfer Aluminium
Eindrähtiger Leiter	0,08 ... 1,5 mm ² / 28 ... 16 AWG
Feindrähtiger Leiter	0,08 ... 1,5 mm ² / 28 ... 16 AWG
Abisolierlänge	8 ... 9 mm / 0.31 ... 0.35 inch
Gesamte Anzahl der Klemmstellen	4
Gesamte Anzahl der Potentiale	2
Anzahl der Ebenen	1
Verdrahtungsart	Frontverdrahtung

Geometrische Daten

Breite	4 mm / 0.157 inch
Höhe ab Oberkante Tragschiene	27 mm / 1.063 inch
Tiefe	73 mm / 2.874 inch

Mechanische Daten

Bauform	horizontale Bauform
Montageart	Tragschiene 35
Beschriftungsebene	Mittenbeschriftung

Werkstoffdaten

Farbe	lichtgrau
Isolierwerkstoff	Polyamid 66 (PA 66)
Brandlast	0.114 MJ
Gewicht	5.946 g

Kaufmännische Daten

Ursprungsland	DE
GTIN	4044918506571
Zolltarifnummer	85369010000
Produktgruppe	1 (Reihenklemmen)
eCl@ss 9.0	27-14-11-20
eCl@ss 8.0	27-14-11-20
ETIM 6.0	EC000897
ETIM 5.0	EC000897

Zulassungen / Zertifikate

Ex-Zulassungen

Logo	Zulassung	Zertifikatsname
	AEx UL International Germany GmbH c/o Physikalisch Technische Bundesanstalt	E185892 Sec.15

Länderspezifische Zulassungen



Logo	Zulassung	Zertifikatsname
	CCA DEKRA Certification B.V.	NTR NL-7081



KEMA/KEUR
DEKRA Certification B.V.

2160584.04

Schiff Zulassungen

Logo	Zulassung	Zertifikatsname
	ABS American Bureau of Shipping	14-HG1293677-PDA
	LR Lloyds Register	91/20112 (E9)

UL-Zulassungen







Logo	Zulassung	Zertifikatsname
	UR Underwriters Laboratories Inc.	E45172

Passende Produkte

Allgemeines Zubehör

	Art-Nr.: 249-105 Gruppenschildträger	www.wago.com/249-105
--	--	--

Brücker

	Art-Nr.: 210-103 Drahtkettenbrücke; isoliert; 50 Anschlüsse	www.wago.com/210-103
	Art-Nr.: 249-123 Steckbarer Leitungsbrücker; isoliert; L = 180 mm; Leitungsquerschnitt 0,75 mm ²	www.wago.com/249-123
	Art-Nr.: 249-125 Steckbarer Leitungsbrücker; isoliert; L = 60 mm; Leitungsquerschnitt 0,75 mm ²	www.wago.com/249-125
	Art-Nr.: 249-126 Steckbarer Leitungsbrücker; isoliert; L = 110 mm; Leitungsquerschnitt 0,75 mm ²	www.wago.com/249-126
	Art-Nr.: 249-127 Steckbarer Leitungsbrücker; isoliert; L = 250 mm; Leitungsquerschnitt 0,75 mm ²	www.wago.com/249-127
	Art-Nr.: 279-482 Brückungskamm; isoliert; 2-fach; IN = IN Klemme	www.wago.com/279-482
	Art-Nr.: 279-483 Brückungskamm; isoliert; 3-fach; IN = IN Klemme	www.wago.com/279-483



Art-Nr.: 279-490
Brückungskamm; isoliert; 10-fach; IN = IN Klemme

www.wago.com/279-490



Art-Nr.: 279-492
Doppelteilungsbrückungskamm; isoliert; 2-fach; IN = IN Klemme

www.wago.com/279-492

Isolierungs-Stopp



Art-Nr.: 279-470
Isolierungsstopp; 0,08 - 0,2 mm² "e" (0,14 mm² "f"); 5 Stück / Strang

www.wago.com/279-470



Art-Nr.: 279-471
Isolierungsstopp; 0,25 mm²; 5 Stück / Strang

www.wago.com/279-471

Beschriftungsmaterial



Art-Nr.: 2009-114
WMB-Inline; für smartPRINTER; auf Rolle; dehnbar 4 - 4,2 mm; unbedruckt; aufrastbar

www.wago.com/2009-114



Art-Nr.: 2009-114/000-002
WMB-Inline; für smartPRINTER; auf Rolle; dehnbar 4 - 4,2 mm; unbedruckt; aufrastbar

www.wago.com/2009-114/000-002



Art-Nr.: 2009-114/000-005
WMB-Inline; für smartPRINTER; auf Rolle; dehnbar 4 - 4,2 mm; unbedruckt; aufrastbar

www.wago.com/2009-114/000-005



Art-Nr.: 2009-114/000-006
WMB-Inline; für smartPRINTER; auf Rolle; dehnbar 4 - 4,2 mm; unbedruckt; aufrastbar

www.wago.com/2009-114/000-006



Art-Nr.: 2009-114/000-007
WMB-Inline; für smartPRINTER; auf Rolle; dehnbar 4 - 4,2 mm; unbedruckt; aufrastbar

www.wago.com/2009-114/000-007



Art-Nr.: 2009-114/000-012
WMB-Inline; für smartPRINTER; auf Rolle; dehnbar 4 - 4,2 mm; unbedruckt; aufrastbar

www.wago.com/2009-114/000-012



Art-Nr.: 2009-114/000-023
WMB-Inline; für smartPRINTER; auf Rolle; dehnbar 4 - 4,2 mm; unbedruckt; aufrastbar

www.wago.com/2009-114/000-023



Art-Nr.: 2009-114/000-024
WMB-Inline; für smartPRINTER; auf Rolle; dehnbar 4 - 4,2 mm; unbedruckt; aufrastbar

www.wago.com/2009-114/000-024



Art-Nr.: 209-128
Adapter

www.wago.com/209-128



Art-Nr.: 209-185
Adapter

www.wago.com/209-185



Art-Nr.: 793-4501
WMB-Beschriftungskarte; als Karte; dehnbar 4 - 4,2 mm; unbedruckt; aufrastbar

www.wago.com/793-4501



Art-Nr.: 793-4501/000-002
WMB-Beschriftungskarte; als Karte; dehnbar 4 - 4,2 mm; unbedruckt; aufrastbar

www.wago.com/793-4501/000-002



Art-Nr.: 793-4501/000-005
WMB-Beschriftungskarte; als Karte; dehnbar 4 - 4,2 mm; unbedruckt; aufrastbar

www.wago.com/793-4501/000-005



Art-Nr.: 793-4501/000-006
WMB-Beschriftungskarte; als Karte; dehnbar 4 - 4,2 mm; unbedruckt; aufrastbar

www.wago.com/793-4501/000-006



Art-Nr.: 793-4501/000-007
WMB-Beschriftungskarte; als Karte; dehnbar 4 - 4,2 mm; unbedruckt; aufrastbar

www.wago.com/793-4501/000-007



Art-Nr.: 793-4501/000-012
WMB-Beschriftungskarte; als Karte; dehnbar 4 - 4,2 mm; unbedruckt; aufrastbar

www.wago.com/793-4501/000-012



Art-Nr.: 793-4501/000-017
WMB-Beschriftungskarte; als Karte; dehnbar 4 - 4,2 mm; unbedruckt; aufrastbar

www.wago.com/793-4501/000-017



Art-Nr.: 793-4501/000-023
WMB-Beschriftungskarte; als Karte; dehnbar 4 - 4,2 mm; unbedruckt; aufrastbar

www.wago.com/793-4501/000-023



Art-Nr.: 793-4501/000-024
WMB-Beschriftungskarte; als Karte; dehnbar 4 - 4,2 mm; unbedruckt; aufrastbar

www.wago.com/793-4501/000-024

Warnabdeckung



Art-Nr.: 279-415
Warnabdeckung; mit schwarzem Blitzpfeil; für 5 Klemmen

www.wago.com/279-415

Werkzeug



Art-Nr.: 210-647
Betätigungswerkzeug mit teilisoliertem Schaft; Klinge (2,5 x 0,4) mm; kurz

www.wago.com/210-647



Art-Nr.: 210-648
Betätigungswerkzeug mit teilisoliertem Schaft; Klinge (2,5 x 0,4) mm; kurz; abgewinkelt

www.wago.com/210-648



Art-Nr.: 210-719
Betätigungswerkzeug mit teilisoliertem Schaft; Typ 1, Klinge (2,5 x 0,4) mm

www.wago.com/210-719

Abschlussplatte



Art-Nr.: 209-191
Trennwand Ex e/Ex i; 3 mm dick; 120 mm breit

www.wago.com/209-191



Art-Nr.: 279-348
Abschluss- und Zwischenplatte; 2 mm dick



















www.wago.com/279-348



Art-Nr.: 279-349
Trennwand; 2 mm dick; überstehend

www.wago.com/279-349

Tragschiene

	Art-Nr.: 210-112 Stahltragschiene; 35 x 7,5 mm; 1 mm dick; 2 m lang; gelocht; entsprechend EN 60715; Lochbreite 25 mm; Lochabstand 36 mm	www.wago.com/210-112
	Art-Nr.: 210-113 Stahltragschiene; 35 x 7,5 mm; 1 mm dick; 2 m lang; ungelocht; entsprechend EN 60715	www.wago.com/210-113
	Art-Nr.: 210-114 Stahltragschiene; 35 x 15 mm; 1,5 mm dick; 2 m lang; ungelocht; ähnlich EN 60715	www.wago.com/210-114
	Art-Nr.: 210-115 Stahltragschiene; 35 x 7,5 mm; 1 mm dick; 2 m lang; gelocht; entsprechend EN 60715; Lochbreite 18 mm; Lochabstand 25 mm	www.wago.com/210-115
	Art-Nr.: 210-118 Stahltragschiene; 35 x 15 mm; 2,3 mm dick; 2 m lang; ungelocht; entsprechend EN 60715	www.wago.com/210-118
	Art-Nr.: 210-196 Aluminiumtragschiene; 35 x 8,2 mm; 1,6 mm dick; 2 m lang; ungelocht; ähnlich EN 60715	www.wago.com/210-196
	Art-Nr.: 210-197 Stahltragschiene; 35 x 15 mm; 1,5 mm dick; 2 m lang; gelocht; ähnlich EN 60715	www.wago.com/210-197
	Art-Nr.: 210-198 Kupfertragschiene; 35 x 15 mm; 2,3 mm dick; 2 m lang; ungelocht; entsprechend EN 60715	www.wago.com/210-198
	Art-Nr.: 210-504 Stahltragschiene; 35 x 7,5 mm; 1 mm dick; 2 m lang; gelocht; bandverzinkt; entsprechend EN 60715	www.wago.com/210-504
	Art-Nr.: 210-505 Stahltragschiene; 35 x 7,5 mm; 1 mm dick; 2 m lang; ungelocht; bandverzinkt; entsprechend EN 60715	www.wago.com/210-505
	Art-Nr.: 210-506 Stahltragschiene; 35 x 15 mm; 1,5 mm dick; 2 m lang; ungelocht; bandverzinkt; ähnlich EN 60715	www.wago.com/210-506
	Art-Nr.: 210-508 Stahltragschiene; 35 x 15 mm; 1,5 mm dick; 2 m lang; gelocht; bandverzinkt; ähnlich EN 60715	www.wago.com/210-508
Aderendhülse		
	Art-Nr.: 216-101 Aderendhülse; Hülse für 0,5 mm ² / AWG 22; ohne Kunststoffkragen; galvanisch verzinkt	www.wago.com/216-101
	Art-Nr.: 216-102 Aderendhülse; Hülse für 0,75 mm ² / AWG 20; ohne Kunststoffkragen; galvanisch verzinkt	www.wago.com/216-102
	Art-Nr.: 216-103 Aderendhülse; Hülse für 1 mm ² / AWG 18; ohne Kunststoffkragen; galvanisch verzinkt	www.wago.com/216-103
	Art-Nr.: 216-201 Aderendhülse; Hülse für 0,5 mm ² / AWG 22; mit Kunststoffkragen; galvanisch verzinkt	www.wago.com/216-201
	Art-Nr.: 216-202 Aderendhülse; Hülse für 0,75 mm ² / AWG 20; mit Kunststoffkragen; galvanisch verzinkt	www.wago.com/216-202
	Art-Nr.: 216-203 Aderendhülse; Hülse für 1 mm ² / AWG 18; mit Kunststoffkragen; galvanisch verzinkt	www.wago.com/216-203
	Art-Nr.: 216-301 Aderendhülse; Hülse für 0,25 mm ² / AWG 24; mit Kunststoffkragen; galvanisch verzinkt	www.wago.com/216-301



Art-Nr.: 216-302

Aderendhülse; Hülse für 0,34 mm² / AWG 24; mit Kunststoffkragen; galvanisch verzinkt

www.wago.com/216-302

Montage



Art-Nr.: 209-106

Haltebock; zur isolierten Montage von Tragschienen DIN 35

www.wago.com/209-106



Art-Nr.: 709-153

Abdeckprofil; Typ 1; passend zu Abdeckprofilträger Typ 1; 1 m lang

www.wago.com/709-153

Downloads

Dokumentation

Ausschreibungstext

279-995	Oct 12, 2017	DOC 25,1 kB	Download
---------	--------------	----------------	----------

smartDATA

CAD Daten

3D Download 279-995	URL	Download
---------------------	-----	----------

Änderungen vorbehalten.

WAGO Kontakttechnik GmbH & Co. KG
Hansastr. 27
32423 Minden
Telefon: +49571 887-0
E-Mail: info.de@wago.com | Web: www.wago.com

Haben Sie Fragen zu unseren Produkten?
Wir stehen Ihnen telefonisch unter +49 (571) 887-44222 gern zur Verfügung.