

Product Description

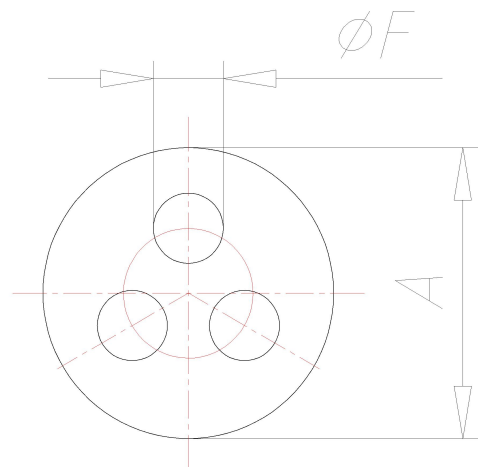

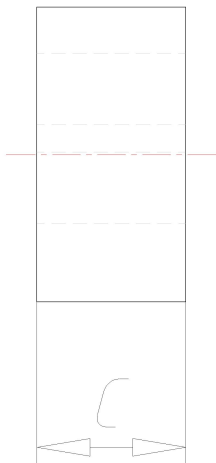
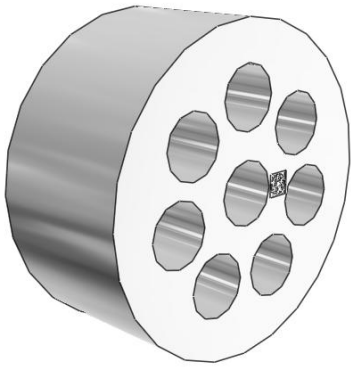

**Technical Data**

ATN	53332850
GR	DIX-M 32
A	25.6
C	12
AB	8
F	5
MATERIAL	NBR