

Product Description

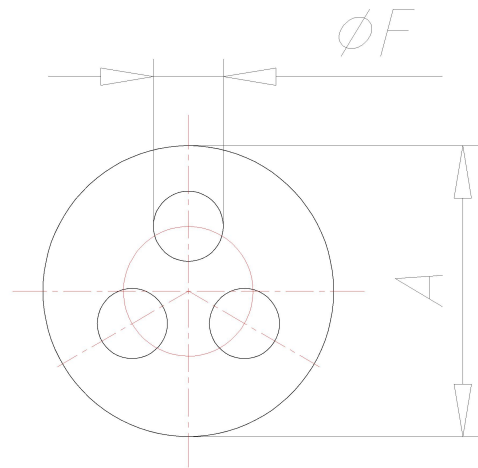

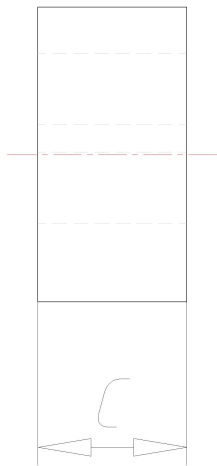
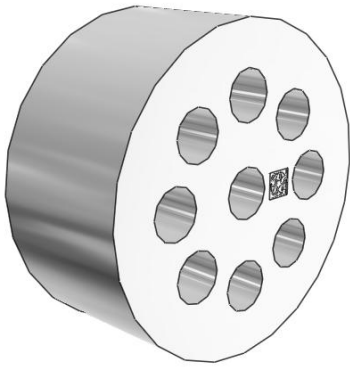

**Technical Data**

ATN	53332940
GR	DIX-M 32
A	25.6
C	12
AB	9
F	4
MATERIAL	NBR