

Product Description

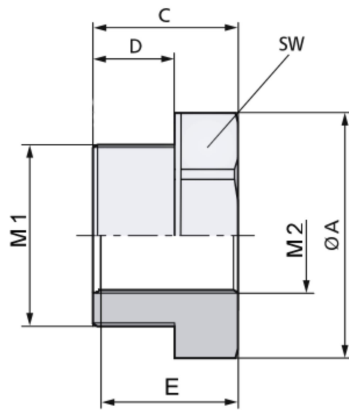

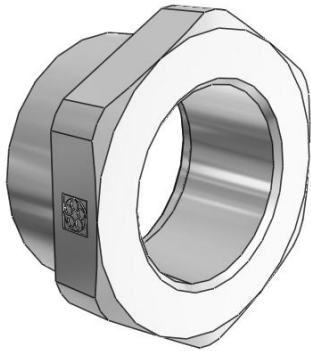

Technical Data

| | |
|----------|------------|
| ATN | 52104478 |
| M1 | M 32x1,5 |
| M2 | M 25x1,5 |
| SW | 36 |
| A | 40 |
| C | 19 |
| D | 12 |
| E | 15.5 |
| RAL7035 | x |
| MATERIAL | Kunststoff |