

Product Description

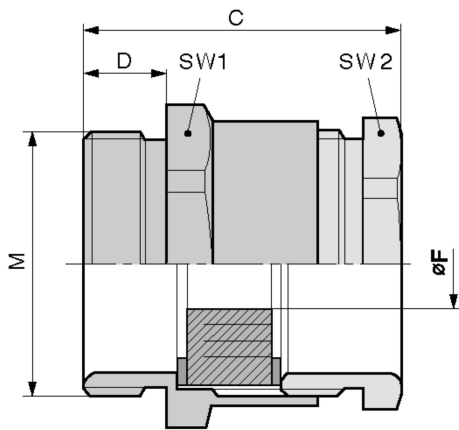

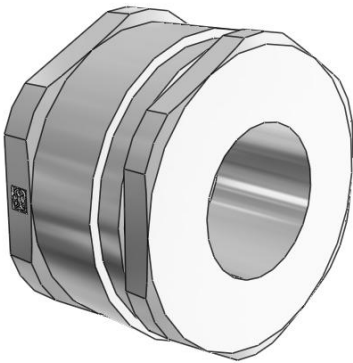

**Technical Data**

ATN	52105004
M	M 40x1,5
FMIN	23
FMAX	34
F	23
SW1	50
A1	54
SW2	47
A2	50.5
C	37.6
D	8
MATERIAL	Messing vernickelt