

Product Description

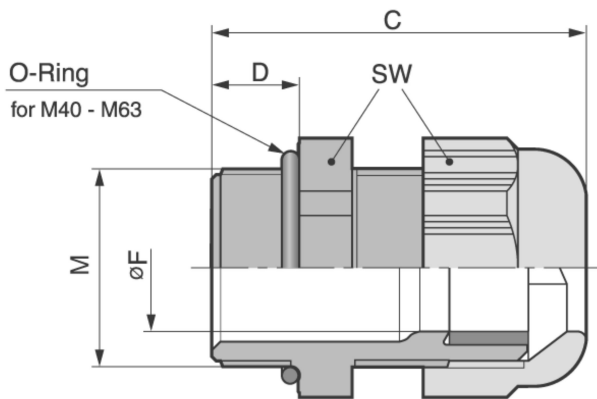

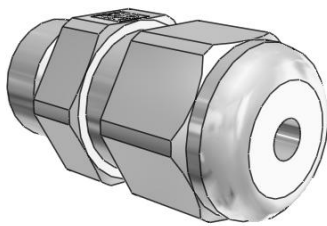

Technical Data

ATN	53111400
M	M 12x1,5
FMIN	3.5
FMAX	7
F	3.5
SW	15
A	16.6
C	30
D	8
RAL7001	
RAL7035	X
RAL9005	
MATERIAL	Kunststoff