

Product Description

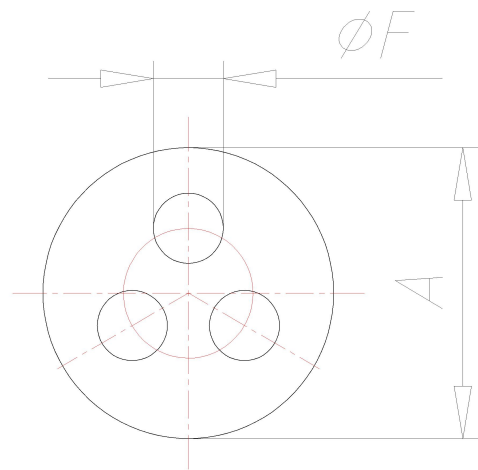

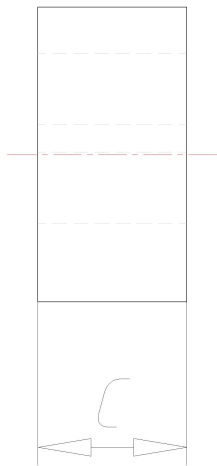

**Technical Data**

ATN	53316230
GR	DIX-M 16
A	12.6
C	8
AB	2
F	3
MATERIAL	NBR