

Product Description

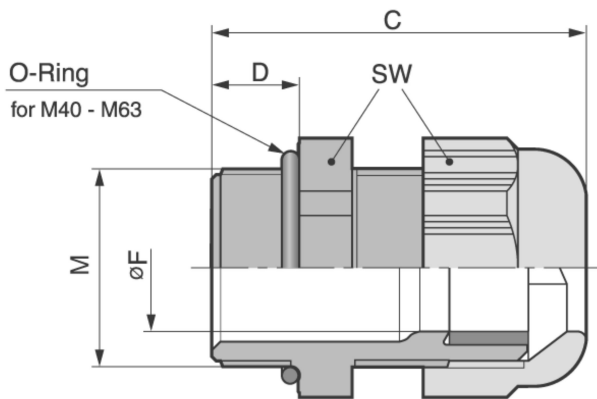

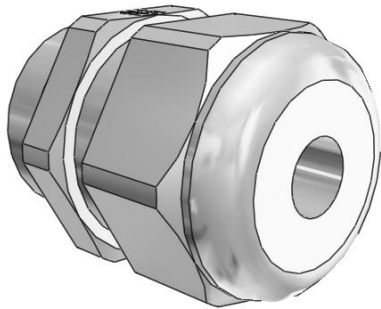

Technical Data

ATN	53111430
M	M 25x1,5
FMIN	9
FMAX	17
F	9
SW	30
A	33.4
C	40
D	10
RAL7001	
RAL7035	X
RAL9005	
MATERIAL	Kunststoff