

Product Description

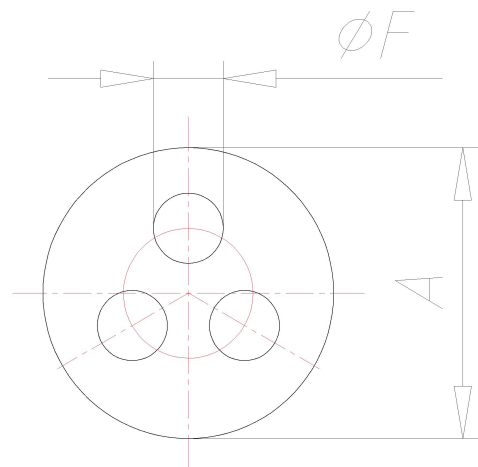

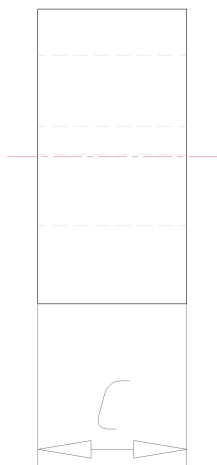
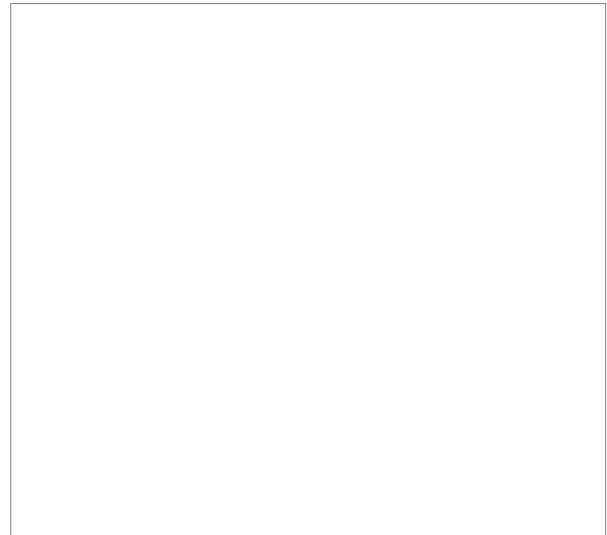

Technical Data

ATN	53320440
GR	DIX-M 20
A	16.6
C	8.4
AB	4
F	4
MATERIAL	NBR