

Product Description

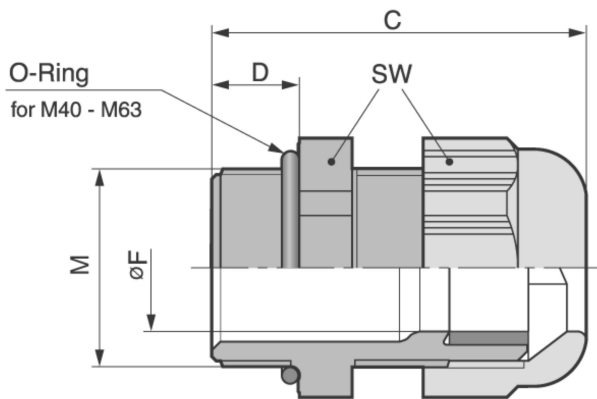

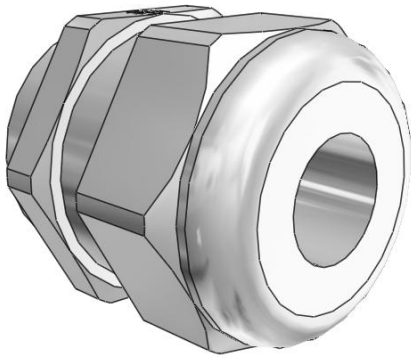

Technical Data

ATN	53111450
M	M 40x1,5
FMIN	19
FMAX	28
F	19
SW	46
A	51.6
C	52
D	10
RAL7001	
RAL7035	X
RAL9005	
MATERIAL	Kunststoff