

Product Description

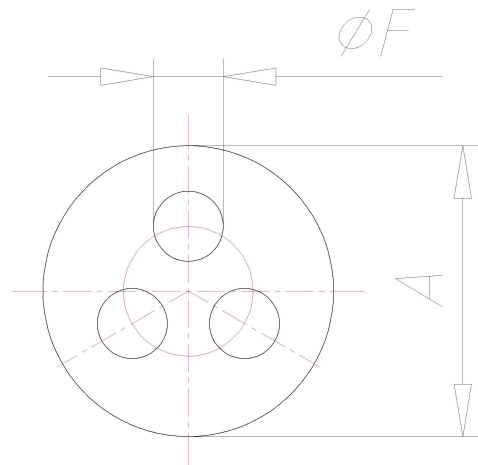

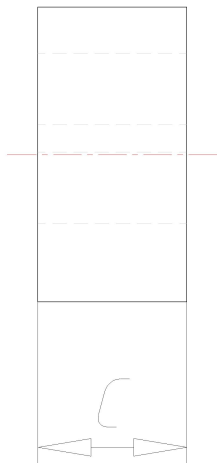
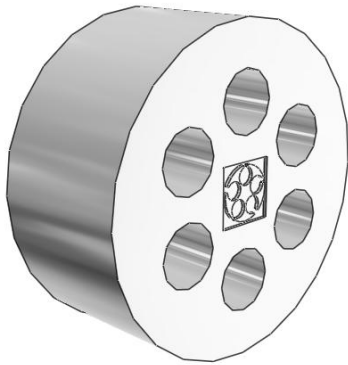

Technical Data

ATN	53325640
GR	DIX-M 25
A	20.8
C	9.5
AB	6
F	4
MATERIAL	NBR